

Development of 3D spatial profiles to support the full lifecycle of 3D objects

Kalogianni, Eftychia; Dimopoulou, Efi; Thompson, Rodney James; Lemmen, Christiaan; Ying, Shen; van Oosterom, Peter

DOI

[10.1016/j.landusepol.2019.104177](https://doi.org/10.1016/j.landusepol.2019.104177)

Publication date

2020

Document Version

Final published version

Published in

Land Use Policy

Citation (APA)

Kalogianni, E., Dimopoulou, E., Thompson, R. J., Lemmen, C., Ying, S., & van Oosterom, P. (2020). Development of 3D spatial profiles to support the full lifecycle of 3D objects. *Land Use Policy*, 98, Article 104177. <https://doi.org/10.1016/j.landusepol.2019.104177>

Important note

To cite this publication, please use the final published version (if applicable).
Please check the document version above.

Copyright

Other than for strictly personal use, it is not permitted to download, forward or distribute the text or part of it, without the consent of the author(s) and/or copyright holder(s), unless the work is under an open content license such as Creative Commons.

Takedown policy

Please contact us and provide details if you believe this document breaches copyrights.
We will remove access to the work immediately and investigate your claim.

Green Open Access added to TU Delft Institutional Repository

'You share, we take care!' - Taverne project

<https://www.openaccess.nl/en/you-share-we-take-care>

Otherwise as indicated in the copyright section: the publisher is the copyright holder of this work and the author uses the Dutch legislation to make this work public.

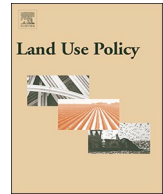

Development of 3D spatial profiles to support the full lifecycle of 3D objects

Eftychia Kalogianni^{a,*}, Efi Dimopoulou^b, Rodney James Thompson^a, Christiaan Lemmen^c,
Shen Ying^d, Peter van Oosterom^e

^a Eftychia Kalogianni PhD Candidate, Delft University of Technology, Faculty of Architecture and the Built Environment, Department GIS Technology, Julianalaan 134, P. O. Box 5030, 2600 GA, Delft, The Netherlands

^b Efi Dimopoulou Professor National Technical University of Athens, School of Rural and Surveying Engineering, P.C. 9 Iroon Polytechniou str., 15780, Athens, Greece

^c Christiaan Lemmen Professor dr. ir. University of Twente, Faculty of Geo-Information Science and Earth Observation/ITC PO Box 217, 7500, AE Enschede, The Netherlands

^d Shen Ying Professor Wuhan University, School of Resource and Environmental Sciences 129, Luoyu Road, 430079, Wuhan, China

^e Delft University of Technology, Faculty of Architecture and the Built Environment, Section GIS Technology, Julianalaan 134, P.O. Box 5043, 2600 GA Delft, The Netherlands

ARTICLE INFO

Keywords:

ISO 19152:2012

LADM

Land administration

3D object lifecycle management

Spatial modelling

3D spatial profiles

1. Introduction

This chapter overviews the background theory and relevant context necessary to understand the scope of the research. Specifically, Sub Section 1.1 presents the concept and characteristics of the object's spatial development lifecycle, Sub Section 1.2 introduces the topic of 3D Cadastre and the importance of standardisation in it, while Sub Section 1.3 discusses the role of land administration within the spatial development lifecycle.

1.1. Spatial development lifecycle of 3D objects

The built environment encompasses associated interdisciplinary aspects of design, construction, management and operation of the created surroundings and artefacts. The key industry sectors directly concerned with these interdisciplinary aspects include the AEC (Architecture, Engineering and Construction) industry, as well as the geography, geoinformation and urban planning industry sectors. Although interwoven in certain aspects, these disciplines rely on different systems in the synthesis and management of information associated with the built environment. This does not only apply to the objects of the built environment that are already constructed, but also to

those that are in the design process.

In the latter case, a full lifecycle information flow starts with information specification from the owner, the designers and contractors and are usually entered into an existing (BIM) database during design and construction. Such information can then be used to populate the existing building manager's asset management/facilities management system database(s) (including links to the BIM model). Most of the spatial and non-spatial data collected during construction is useful during operations (floor plans and 3D models – both geometry and associated attributes/data).

It should also be considered that financial, building/ construction permit, occupancy, maintenance historic process and other information are considered as vital aspects of an object's spatial development lifecycle and should be maintained and exchanged between its various phases. At the centre of this lifecycle the registration of a (built environment) object in a cadastral database can be found and thus, it is vital to consider workflows to exchange and reuse this information between the phases. Undoubtedly, the utility of 3D modelling is at multiple levels but out of the five core phases in the lifecycle - plan, design, construct, register and operate - the usage varies based on requirements.

Within this framework, the interoperability concept covers areas of

* Corresponding author.

E-mail addresses: E.Kalogianni@tudelft.nl (E. Kalogianni), efi@survey.ntua.gr (E. Dimopoulou), rodmnaria@gmail.com (R.J. Thompson), c.h.j.lemmen@utwente.nl (C. Lemmen), shy@whu.edu.cn (S. Ying), P.J.M.vanOosterom@tudelft.nl (P. van Oosterom).

<https://doi.org/10.1016/j.landusepol.2019.104177>

Received 25 April 2019; Received in revised form 13 August 2019; Accepted 19 August 2019

Available online 22 January 2020

0264-8377/ © 2019 Elsevier Ltd. All rights reserved.

legal, organizational, semantic and technical nature and provides the fundament for sustainable data management and value creation. In this context, data infrastructure(s) of the different involved disciplines must take account of interoperability issues and set up on commonly agreed international standards and modelling rules.

1.2. 3D cadastre

As cities grow, both vertically and horizontally, the concept of the third dimension is introduced (FIG, 2018b). Current Land Administration Systems (LASs) still mainly rely on 2D-based cadastral systems facing legal, organisational and technical challenges in recording, managing and visualising the spatial extent of vertically spaces due to the increasing complexity of infrastructures (Aien et al., 2013; van Oosterom, 2013; Kalogianni et al., 2017; Atazadeh et al., 2016; Kitsakis et al., 2016). Cadastral Systems are recognized as the core of LASs containing identification of the individual parcels recording interests above/below/on land and water surface.

Currently, cadastral and land administration organisations around the world are taking steps to register multi-level property rights and space rights, in such a way that the registration provides a clearer insight of the legal situation. In recent years, 3D cadastral developments have matured, with the number of partial implementations of 3D parcel registration around the world to be significantly increased (some jurisdictions provide legal provisions for the registration of 3D parcels; others show 3D information on cadastral plans such as isometric views, vertical profiles or textual information; etc.) (Kitsakis et al., 2016; Dimopoulou et al., 2018; Ying et al., 2015). In this scene, the contemporary advances in geographic information science and technology enable the collection, storage, analysis, visualization and dissemination of 3D objects and play an important role.

An inventory of the current status of 3D cadastral registrations worldwide is explicitly described by Dimopoulou et al. (2018), highlighting the first 3D cadastral registration in the Netherlands (Stoter et al., 2017) and the real 3D cadastre and information systems, which are built in Shenzhen, China to support urban planning and management (Guo et al., 2014; Ying et al., 2015). Additionally, at the 3rd Fig. 3D Cadastres Questionnaire (Shnaidman et al., 2019) a comprehensive current (2018) state-of-the-art of 3D Cadastres status worldwide is presented, as well as near future (2022) plans and expectations in the field are discussed. Achieving the registration of 3D parcels has been an important step forward, however, sharing, visualising and using these 3D parcels is another challenge (van Oosterom, 2019).

Despite the technological benefits and the potential economic value of applying a holistic 3D approach, 3D solutions and practices are still not common in applications that could significantly benefit from them. In the context of object lifecycle management and 3D data reuse this can be achieved, as data from 3D survey and design (especially from BIM models, lidar data, etc.) are now becoming more and more available, while it has been claimed (Oldfield et al., 2017) that BIM (and especially IFC data models and CityGML data) could be a good source for retrieving data for 3D cadastral registration, such as detailed geometry and semantics (Ying et al., 2017).

In the context of 3D objects' lifecycle management, it is supported (Stoter et al., 2016) that adopting a 3D approach from the initial phases of the object lifecycle (i.e. design and acquisition) saves large amounts of time and effort, mistakes are avoided, and it is less expensive. Therefore, all the involved experts in the different lifecycle phases would benefit from 3D datasets and procedures, either by representing a model of the current real-world or a design of proposed scenarios (e.g. architectural, spatial planning, subdivision plans, etc.). What is more there is a rapidly expanding need for 3D geodata driven by the huge – and ever-growing – interest in the construction of 3D models of urban and built environments, which leads to the fact that 3D datasets are becoming more and more ubiquitous for making decisions and improving the efficiency of governance in different levels.

Given that (spatial) information comes from many different sources and is managed by a very large number of different providers, there is an overwhelming requirement to easily discover and share this information. Standards have a key role in this respect and are essential to delivering authoritative geospatial services and products which meet the requirements of the wider community of users. (UNGGIM, 2018). Much effort is made in the AEC and GIS domains to address interoperability issues via standardised approaches and exchange formats.

The most dominant standardised model in the field of land administration, is the Land Administration Domain Model, which has been voted as ISO standard in 2012; ISO19152:2012 (ISO, 2012); and is one of the first spatial domain standards within ISO TC 211. The growing recognition and influence of LADM is revealed by the multiple country profiles that have been developed so far by many countries worldwide. Within the International Standardisation Organisation (ISO), standards, which are actually being applied, are continued and subject to periodic revision, typically in a 6 to 10-year cycle (van Oosterom et al., 2019). In this context, the LADM revision has started in 2018 aiming to provide better tools to improve tenure security and better land and property rights for all, involving many stakeholders. LADM Edition I revision's scope and core objectives are described in Section 2.

1.3. Land Administration in the context of full lifecycle of 3D objects

In many global documents (such as the United Nations Agenda for Sustainable Development Goals (SDGs) (World Bank, 2018), the Voluntary Guidelines on the Responsible Governance of Tenure (VGGTs) initiated by UN FAO (FAO, 2012), the New Urban Agenda (NUA) from Habitat III (Habitat, 2016), the 14 global fundamental geospatial data themes by UN-GGIM (UNGGIM, 2019a), etc.) land is considered as an issue of utmost importance (Lemmen, 2012) related to many of their indicators and targets. Improving land administration and management practices often results to increase in long-term and sustainable investment opportunities, both in rural and urban areas globally. In this context, spatial information is broadly recognized as critical tool to support national development, economic growth, and improve policy-making. Maximizing the value of fundamental spatial information, decisions and actions are going to be critical the next decades, while the need for continuing research on principal policy issues of technical, administrative, legal and financial aspects of land administration, as well as the adoption of standardised, accessible and transparent approaches (Lemmen et al., 2017) will grow significantly.

In this scene, the ongoing process of improving Land Administration Systems (LASs) is crucial, since land administration is the key asset of any country, being crucial for its sustainable development as it covers both legal aspects (Rights, Restrictions, Responsibilities) and spatial descriptions (parcels forming cadastral maps). It responds to the need for international research in building effective land administration infrastructures with modern information technology that will support the 2030 global policy goals for sustainable development (van Oosterom, 2019).

To this end, land administration should not be treated as an isolated sector, but as part of a whole chain of spatial development phases, which should all be well aligned and supported by 3D representation (Fig. 1). Land administration is on the centre of this lifecycle facing challenges of sustainability and cumulative space demand. As also stated by van Oosterom (2013), the naming and order of execution of the object's lifecycle phases (namely: spatial planning/zoning, designing, financing, permitting, surveying, constructing, registering, financing, using, maintaining objects) may differ from country to country, however they portray the general process.

Currently, there are independent and specific phases through the spatial development lifecycle of objects, involving multiple stakeholders (planners, designers, developers, surveyors, financiers, etc.) from various domains with different backgrounds, tools, custom-made methodologies and requirements. However, present situation in many

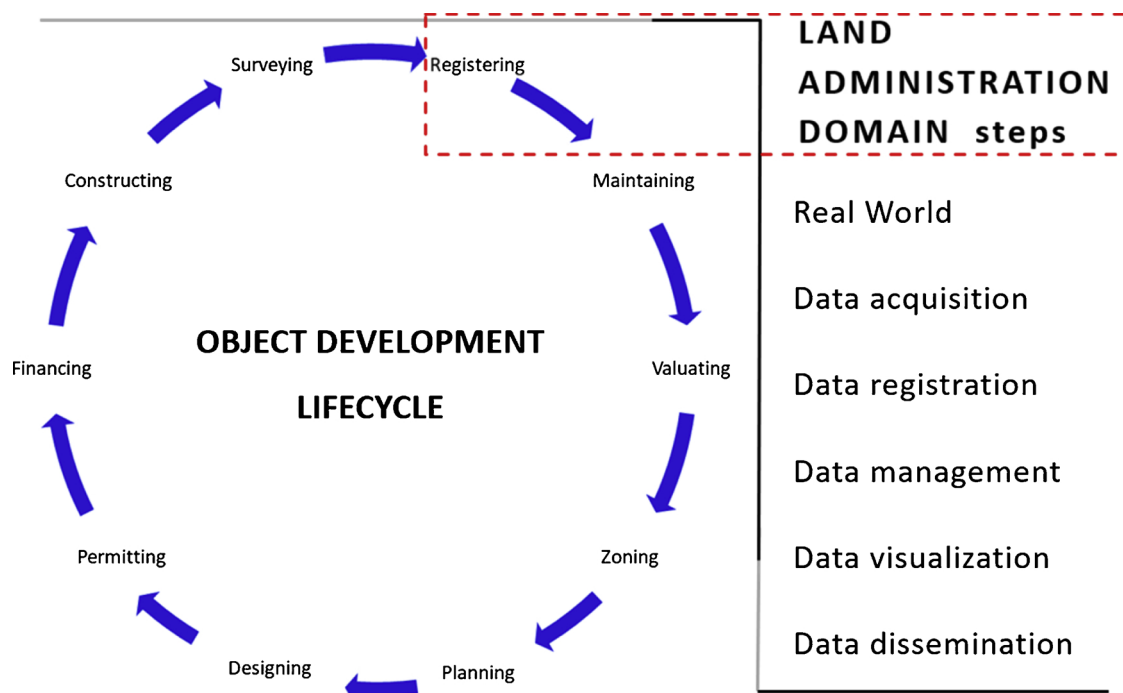

Fig. 1. 3D Cadastre within the spatial development chain (Kalogianni et al., 2018a, annotated).

countries, has proven slow and expensive, with inconsistent datasets and duplicates for the same objects through different phases of its lifecycle, which results in mistakes.

Fashioning AEC (Architecture, Engineering and Construction), geospatial and economic data into an efficient data flow from planning through design and construction to operation and maintenance phase, represents a challenge. Collaboration between different sectors reduces costs of acquisition and design -data is collected once and used multiple times in all the phases-; it improves data quality; reduces inconsistencies and avoids duplication in data collection and management and minimises data loss, mismatch and overlap between the various stages.

The potential for the reuse of information within the spatial development lifecycle is a significant factor in calculating its (economic) value; namely because of avoiding inconsistencies and mistakes, while by adding real-world coordinates, the value and types of data are increased for all stakeholders. Therefore, it is necessary to adopt bottom-up and top-down governance approaches and policies, regarding data acquisition and registration, as well as data processing and sharing from different heterogeneous sources, by working with international standards.

Given this background, a life-cycle thinking approach, in the context of an integrated development chain, can improve the efficiency of current situation. Thus, a holistic approach to share and reuse information related to design, construction, legal, administrative, environmental and social issues should be developed and implemented. Till today, international experience is limited to such a holistic approach, mainly focusing on the dissemination of information between organisations in industry and governmental level, while academic research is carried out mostly towards the synergy between the design and construction sectors (high attention draws the solutions/possibilities for BIM-CAD integration).

In this context, Guo et al. (2014) present a 3D business workflow covering the lifecycle of a (3D) object, implemented in Shenzhen city of China, which divides in three main phases: project preliminary, project design and project construction. To support the lifecycle, the proposed 3D cadastral administrative system includes three modules: 3D data generation module (manual input, data input and interactive

configuration), 3D query-platform and 3D mapping module (visualisation through 3D scene including 3D cadastral data, 3D buildings and city environment auxiliary elements), which are built based on the 3D land and planning database. What is more, the workflow supports a 3D certificate function, as an independent module, which provides 3D certificates in various formats (in pdf, jpeg and tiff) depending on the relevant laws and regulations.

2. ISO 1952:2012 Land Administration Domain Model (LADM) revision

The design of LADM took place in an incremental approach, involving international experts, which lasted from 2002 to 2012, when it was accepted as ISO standard and Edition I was published (Fig. 2).

A New Working Item Proposal (NWIP) has been submitted to ISO TC211 in May 2018 by FIG, in order to initiate the LADM revision process. The NWIP provides an overview of needs and requirements of the identified LADM improvements at the conceptual model, the extensions at the scope of the conceptual model, possible encodings/technical models, as well as process models (Fig, 2018a).

The ongoing revision is a joint activity, supported by many organisations and institutions (ISO, OGC, World Bank, UN-GGIM, GLTN, FIG, IHO, RICS, Kadaster, TUDelft, etc.). Each one will be involved and contribute to different aspects of this process. The ambition is to go beyond a simple conceptual model by providing steps towards implementations (e.g. more specific profiles, technical model in various encodings, etc.), intending to achieve backwards compatibility, thus the first edition of LADM to be upwards compatible with future editions, which may have an extended scope.

Sub Section 2.1 introduces the proposals to extend the scope of LADM Edition I, which are currently under development. The improvements of the conceptual model are briefly described in Sub Section 2.2, while the Sub Section 2.3 presents the workflows and process models that will be introduced in Edition II of the standard.

2.1. Extension of the scope

Among others, it is proposed to extend the scope of LADM with a

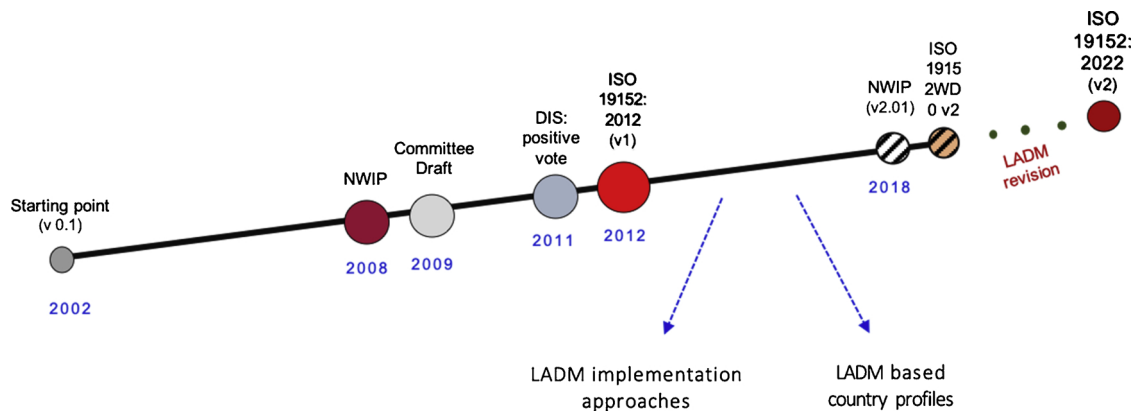

Fig. 2. LADM incremental design.

valuation perspective, introducing a Valuation Information Model (Kara et al., 2018) based on Çağdaş et al. (2016) and Çağdaş et al. (2017). The Valuation Information Model, which is introduced, will serve for the specification of inventories or databases used in valuation for recurrently levied immovable property taxes. The LADM Valuation Information Model is supposed to facilitate all stages of immovable property valuation, namely the identification of properties, assessment of properties through single or mass appraisal procedures, generation and representation of sales statistics, and dealing with appeals (Kara et al., 2018).

Another goal of the revision is to include spatial planning/zoning with legal implications and therefore, a Spatial Planning Information Model is proposed. Spatial planning is considered to be closely related to cadastre, as it may involve consultation and mediation processes in developing new land use plans (FIG, 1995). The proposed Spatial Planning Information Model aims to provide an effective way to relate land tenure and spatial information, covering multiple levels of spatial themes (e.g. land cover, land use, utilities, regulatory zones and reporting units, natural risk zones, etc.) (van Oosterom et al., 2019).

Concerning the survey techniques that are part of LADM Edition I, by reference to the ISO19156 - Observations and Measurement Standard (ISO, 2011), it is investigated to develop a refined survey model.

Moreover, an integration model of LADM with IndoorGML to assign Rights, Restrictions and Responsibilities (RRRs) to indoor space and indicate the accessible spaces for each type of user (party) is being proposed for the LADM Edition II. By representing the party types of the indoor spaces, LADM could establish a relationship between the indoor space and the party. As a result, the navigation process will be more convenient and straightforward, as the navigation route will avoid non-accessible spaces based on the rights of the party (Alattas et al., 2017; van Oosterom et al., 2019).

Furthermore, acknowledging the importance of marine environment and the demand to register Marine Limits and Boundaries (MLBs), as well as the Rights, Restrictions and Responsibilities that apply to them, a normative reference to the standard S121 (Marine Limits and Boundaries) developed by the International Hydrographic Organisation (IHO) will be included in the Edition II of LADM.

Last but not least, LADM Edition II is considered to be among the internationally agreed standards that will play a key role alongside agreed global concepts and evidence-based approaches. The Global Land Indicators Initiative (GLII), see GLTN/UN Habitat/Kadaster (2015); Habitat/GLTN (2017) and UN ECOSOC and African Union (2016) seek to derive a list of globally comparable harmonized land indicators, using existing monitoring mechanisms and data collection methods as a foundation, and it is expected that with the development of land administration indicators for the SDGs as part of LADM Edition II, this problem will be addressed.

2.2. Improvements at the conceptual model

LADM provides an international framework, conceptually effective to support 3D Cadastre and is worldwide gaining ground, as many 3D Cadastral prototypes and pilots are developed based on that. However, at its current version the 3D support is limited and there is a need to complement and refine its 3D functionality and thus design detailed 3D spatial profiles for the different types of spatial units. Moreover, more functionality is required for 4D representations, including geometry or topology and time profiles.

From the multiple country profiles that have been developed till today, it has been noticed that code lists are being repeated (when a country-specific code list is introduced in a country profile, the country code is replaced with 'LA' prefix), LADM code lists are being extended with new values to serve the needs of the country profile, while the localization issue extends from language names to the various organizations and institutions dealing with interests in land.

To address those challenges, Paasch et al. (2015) and Stubkjær et al. (2018) propose code lists as a means of internationalisation by which the classes of the LADM may be related to the jurisdiction concerned. The issue of code lists has been addressed by the OGC as well, namely in terms of the document 17-050r1 Code List Manifesto (Scarponcini, 2017). Meta data and tenure atlases are relevant in this context. Tenure atlases provide an overview on tenure systems and the level of recognition. This may include areas without land markets and nature preservation etc. Therefore, formal semantics and/or ontology of code lists will be included in the Edition II of the standard.

What is more, one of the objectives of the LADM Edition II is to go beyond just a conceptual model and hence, exploring various encodings concern the further detailed technical specification of LADM based on existing standards. Mainly the use of international standards will be explored through this revision and specifically, BIM/IFC, CityGML, LandXML, InfraGML, IndoorGML, RDF/linked data, GeoJSON and INTERLIS. It is underlined that BIM is very important in order to establish a link between building information and land administration domain in relation to spatial planning and lifecycles of constructions/buildings.

2.3. Process models and workflows

At the conceptual model of LADM Edition II process models for survey procedures, map updating and transactions (including blockchain) will be included. Generic process-related modules in data acquisition, data handling and also maintenance and publication are needed.

LADM in its current edition has roles already included, as well as a series of dates as interaction processes; however, the standard does not include land administration processes for initial data acquisition, data maintenance and data publication (Lemmen et al., 2018).

In this context, cadastral map updating includes adjustments and transformations of field observations (collected at different moments in time and with different survey instruments or use of imagery from different sources) to the spatial database. Management of values/measures is needed – there may be more than one value to be maintained for the same spatial unit – the legal area and the accurate area as calculated in the cadastral GIS. Implementation of tolerances to manage the differences should be flexible and purpose related. Results of subdivisions of spatial units may need to be shared with other systems. This includes results of readjustments and land consolidation (van Oosterom et al., 2019).

Processes that will be included in Edition II of the standards, will be organized per package (the 3 core packages as they have been described in LADM Edition I: Party, Administrative and Spatial Unit), also covering the newly introduced in Edition II packages for Valuation and Spatial Planning and will cover both data input and output (van Oosterom, 2019). Each process encompasses principle components and forms the legal or spatial correlation between them and therefore, each element can be cross-connected to a corresponding LADM Class.

Processes can also be organized on the basis of use of electronic signatures in case of applications and information requests with public and private keys and encryption/decryption. Provision of information to data collectors for initial data collection or maintenance is a specific but very important process (task management, logistics).

Similarly, blockchain technology in transaction processes could be very well applicable for transactions in land administration. Another type of UML diagram may be needed to represent processes – thereby creating a connection between the classes of workflow management module and LADM classes.

3. Spatial profiles in the context of ISO 19152:2012 LADM Edition I

Spatial profiles can efficiently support a holistic lifecycle thinking and enhance the interoperability between the different phases and disciplines. The spatial profiles that have been developed in the context of LADM Edition I are described in this Section. Specifically, Sub Section 3.1 presents the five 2D spatial profiles, according to the representations that are supported by the current Edition of the standard and Sub Section 3.2 briefly introduces the 3D topological profile and the related research in the field of 3D topology models.

3.1. 2D spatial profiles

At the first edition of LADM (ISO19152:2012), the Spatial Unit Package and the Spatial Representation and Survey sub-packages allow a number of possible representations of spatial units in 2D, 3D or mixed (integrated 2D and 3D). For 2D spatial units five spatial representations are supported in the current Edition of LADM, which form the corresponding spatial profiles described with a small UML diagram (Annex E ISO 19152, 2012).

The spatial profiles for 2D spatial units allow for a representation only with descriptive text, where no geometry is used ('text based' spatial units), as illustrated in Fig. 3.

A spatial unit can also be described by the coordinates of a single point, as presented in the spatial profile illustrated in Fig. 4.

What is more, the representation of a spatial unit with lines and incomplete boundaries, can be modelled through the profile presented in Fig. 5.

The most common representation by a 2D polygon is illustrated in Fig. 6.

Last but not least, a profile for representation when spatial units share boundary representations is included in LADM Edition I (Fig. 7).

The liminal spatial units (mixed 2D/3D) are introduced in Annex B of ISO 19152 (ISO 19152, 2012), however there are no spatial profiles for their representation.

3.2. 3D spatial profiles

At the current edition of LADM one spatial profile for 3D spatial units is provided (Annex E ISO 19152, 2012); the "3D Topological based" (Fig. 8). Regarding the 3D topology model, volumes should not overlap but may be open on the bottom or the top corresponding to non-bounded 3D Spatial Units (in this case, the size of the volume cannot be calculated) (Zulkifli et al., 2015). In terms of a 3D topology representation, a 3D boundary face has positive/negative information included in the association with a 3D spatial unit to indicate the orientation of the face, however the geometric 3D volumetric primitive (GM_Solid) is not indicated as this is the topological representation (Ying et al., 2015).

Zulkifli et al. (2015) review different 3D topological models to choose the most suitable one for certain applications within LADM concept. The authors conclude, that there is no single 3D topology model best suitable for all types of applications, as it depends on the type of each application and therefore, the requirements of the 3D topology model should be defined accordingly. Based on their research, a "topological structure to organize tetrahedrons", Tetrahedral Network (TEN) introduced by Penninga and Oosterom (2008), is one of the most suitable 3D topology models.

According to the requirements of the LADM, considering topological information alone is not sufficient to describe a 3D object. Geometrical information must also be associated with each topological primitive. In this context, Ying et al. (2015) proposed a model to describe and store the geometric and topological relationships of 3D cadastral units, as well as the entities. The authors extend the geometric-topological model in LADM, which is based on ISO 19107, and redesign the model to support non-manifold 3D objects to represent realistic 3D cadastral objects.

4. Proposed spatial profiles in the context of ISO 19152:2022 LADM edition II

The work described in this Section is focused on the development of spatial profiles in the context of LADM revision, based on the revised taxonomy, as initially presented by Thompson et al. (2015), as well as in previous work of the authors (Kalogianni et al., 2018b).

Sub Section 4.1 introduces generic use cases that have motivated the categorisation of spatial units into discrete groups with similar characteristics. Use cases from China, Greece and Australia have been gathered and analysed. As a next step, the revised classification of 3D spatial units, as initially provided by Thompson et al. (2015) is briefly introduced in Sub Section 4.2, while Sub Sections 4.7, introduce the proposed 3D spatial profiles to be included in the revised Edition of LADM. Lastly, Sub Section 4.8 presents a reflexion on the spatial profiles modelling approach and the aspects that have been considered to reach those preliminary results.

4.1. Inventory of use cases

Use cases of 3D spatial units that commonly appear at the different jurisdictions around the world are the starting point for the categorisation of the use cases that show similar characteristics into groups, and then, the modelling of their corresponding spatial profiles. In this research, use cases from Australia, China and Greece are presented.

The six states of Australia operate under subtly different regulations; hereafter the use cases that are being analysed in the context of this research reflect the reality in Queensland (DNRM, 2016). Historically, cadastral spatial units were seen as 2D land parcels, but with the interpretation that the property extended from the centre of the earth to an infinite distance above the surface. In practice, this was always treated as meaning the distance above/below ground that the property owner had effective control over. The concept of "to the depth/height of" properties was introduced in the early 20th Century to permit cases

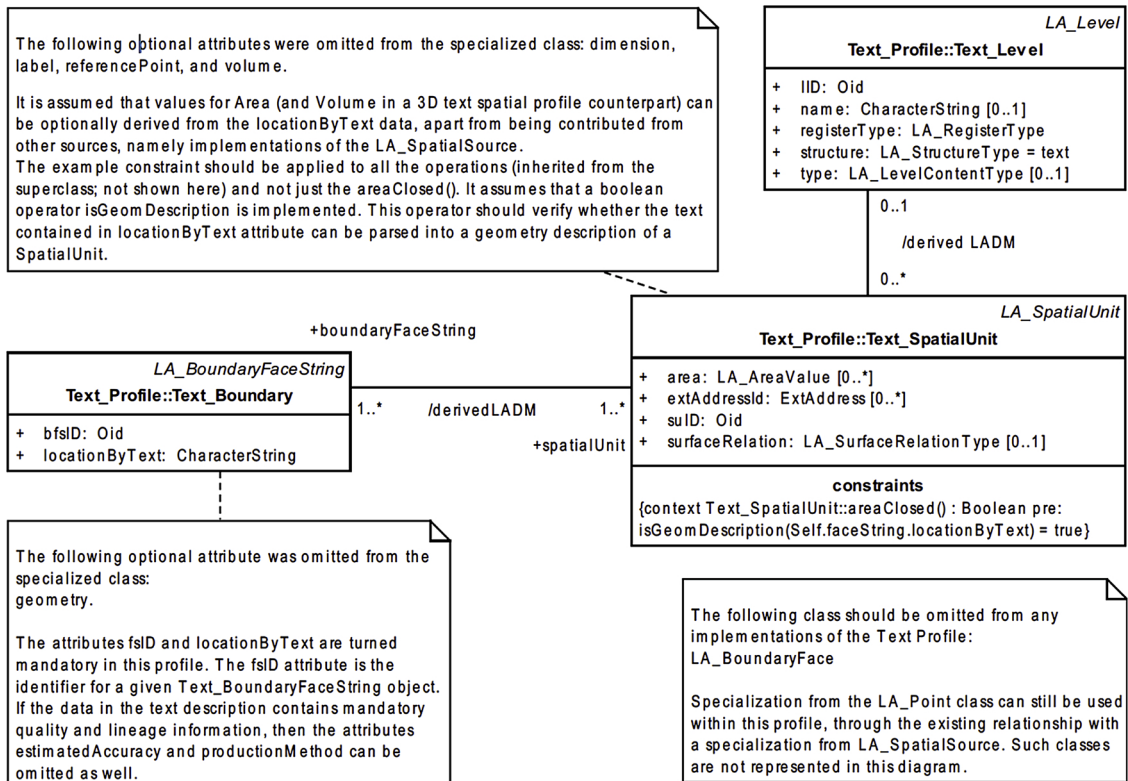

Fig. 3. Current 2D text based spatial profile, Annex E - LADM ISO 19152 (ISO 19152, 2012).

such as mines that were constructed below surface properties.

The next major change in Australia, during the late 1980's was the introduction of "strata titles" which referred to units within buildings with the properties defined by the building structure, and then in the early 21st Century, "volumetric" spatial units – where the definition of

the property does not depend on a structure, but is defined by metes and bounds (like a 2D parcel). The legal situation of 3D spatial units has been kept simple by them being given the same status in law as 2D spatial units. A valid interpretation of this is that, a volumetric spatial unit today can be subdivided into individual units – each of which is

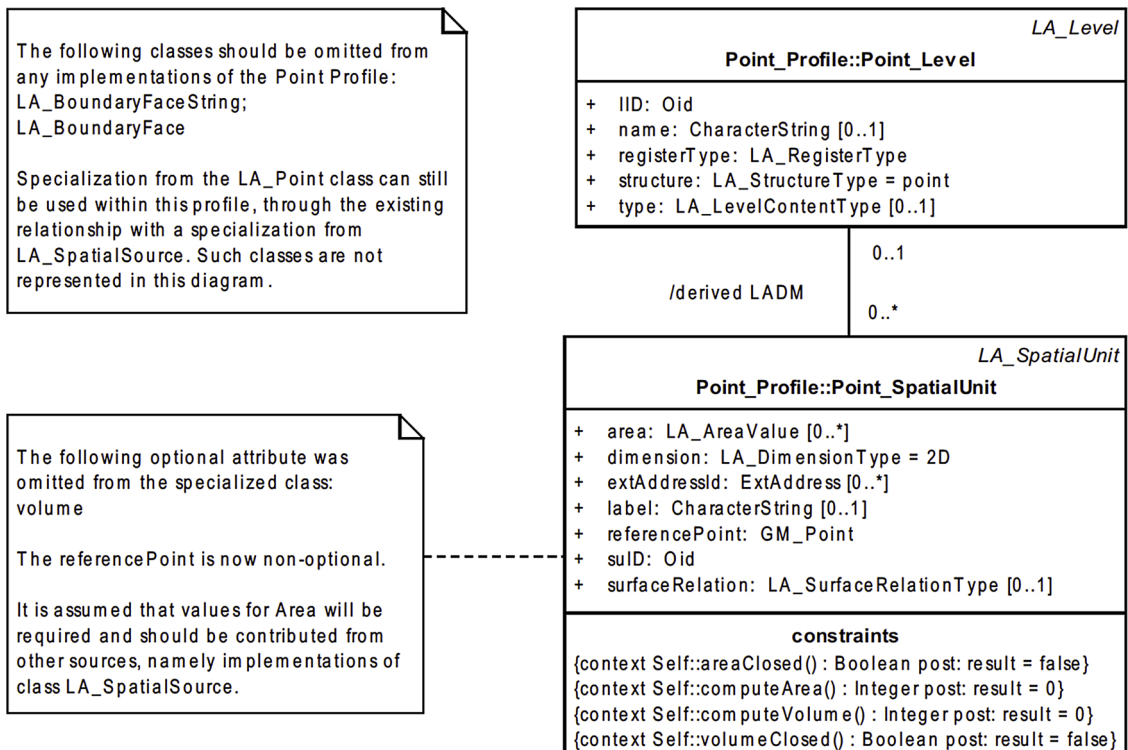

Fig. 4. Current 2D point based spatial profile, Annex E - LADM ISO 19152 (ISO 19152, 2012).

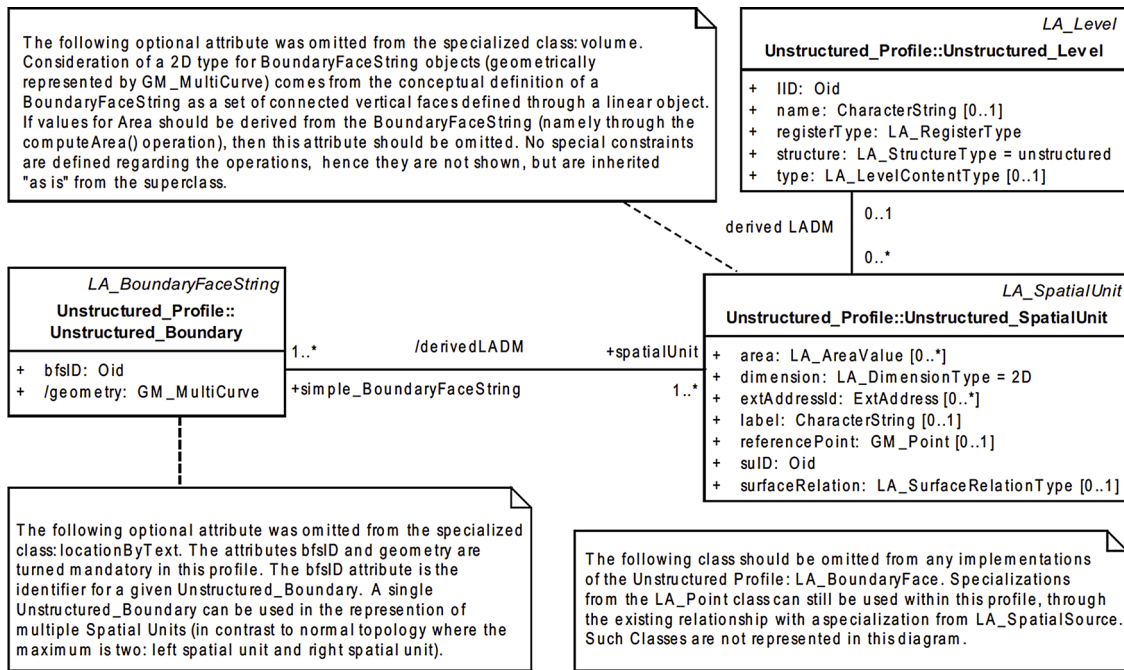

Fig. 5. Current 2D unstructured line based spatial profile, Annex E - LADM ISO 19152 (ISO 19152, 2012).

subject to a strata title (3D spatial units within 3D spatial units, a concept that is currently supported also by the Edition I LADM). This raises a particular type of “common property” being the remainder of a volume of space after the individual units have been excised. Having said that, two representative 3D use cases from Australia are presented: a busway and a complex building structure.

Therefore, Fig. 9 illustrates a common use case of a busway (the larger parcel) with a section of tunnel below it. They both have been pushed up to above the surface to make them visible in Google Earth, which does not allow for visualising underground objects and spaces (while the busway is actually at the earth’s surface). Both the tunnel and the busway are volumetric spatial units, and the top one (busway) is a stepped slice, while the lower tunnel spatial unit is a simple slice with non-horizontal top and bottom.

Fig. 10 shows Meriton (or Soleil) Building, the tallest building in

Brisbane, which is actually divided into 4 volumetric lots. The lots are subdivided into building unit lots (specifically, in the figure lot 3 is presented, which is subdivided into floors, each with 7 building format lots and common property. The volumetric lots are general (having various ramps and complex structured), but the individual building unit lots are all simple slices, defined by the walls of the building.

Fig. 11 illustrates a complex case with a five-storey building and a tunnel below it, where also the corner is truncated to improve traffic flow. Concerning the geometry of the spatial units, there is a simple slice volumetric spatial unit below ground, and a building with building format units (simple slices) at and above ground level (Thompson et al., 2016). At the Fig. 11, with green are the floors and ceiling, which are shared from units to the ones above/below them.

Over the last decade, China, and specifically the city of Shenzhen, has shown advanced 3D cadastral applications, as also mentioned in

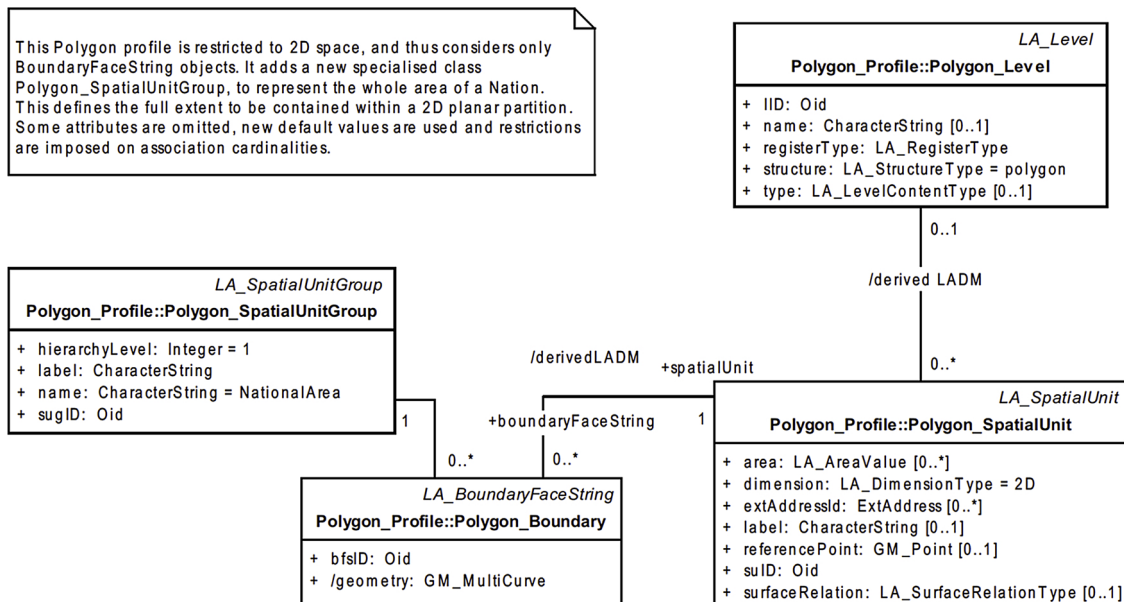

Fig. 6. Current 2D polygon based spatial profile, Annex E - LADM ISO 19152 (ISO 19152, 2012).

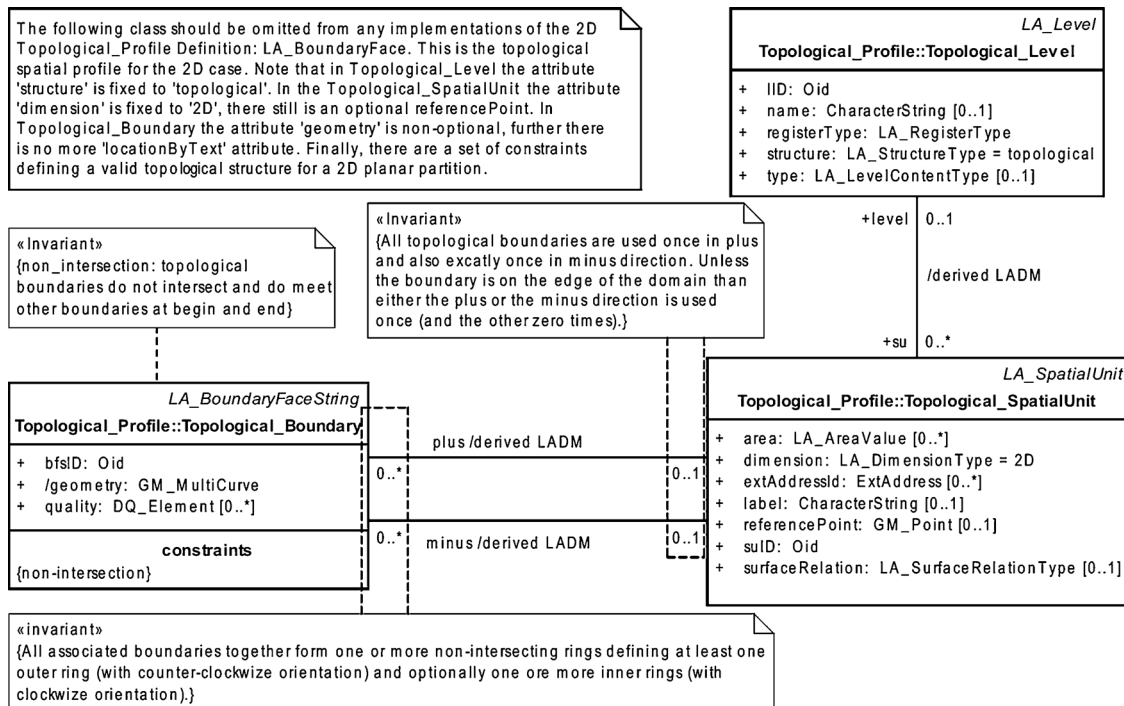

Fig. 7. Current 2D topology based spatial profile, Annex E - LADM ISO 19152 (ISO 19152, 2012).

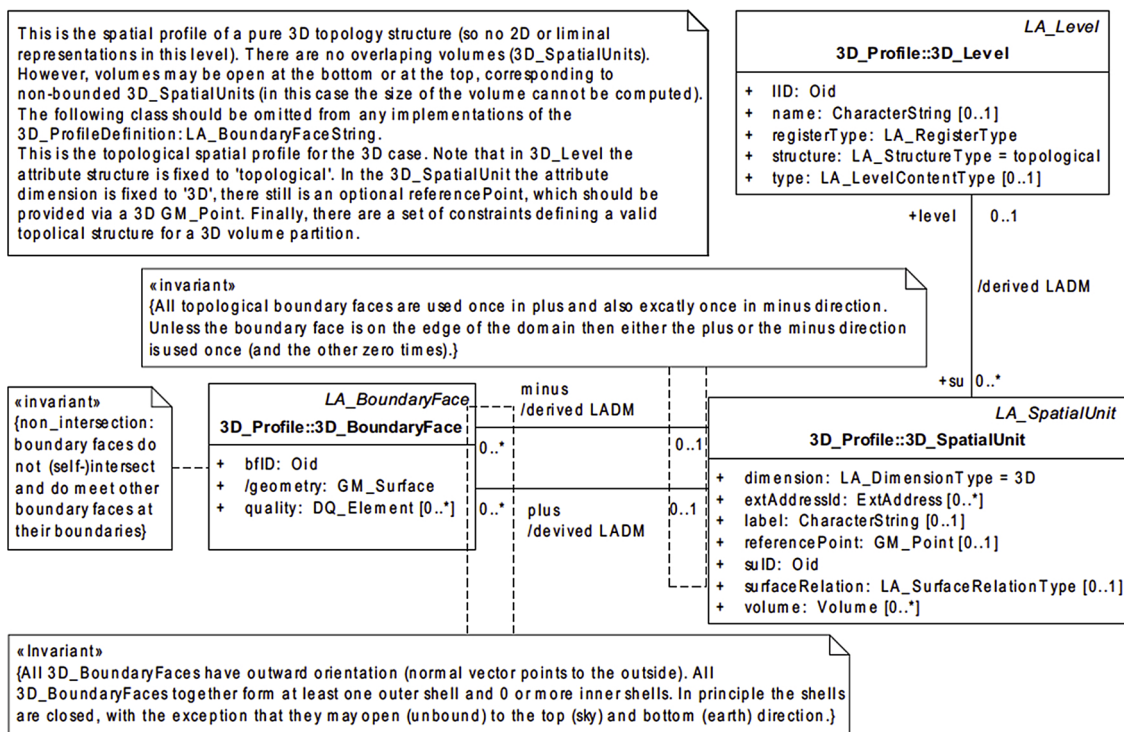

Fig. 8. Current 3D topology based spatial profile, Annex E - LADM ISO 19152 (ISO 19152, 2012).

Sub Section 1.3. Hence, three use cases are presented here, referring to common 3D space blocks, underground properties and a complex collection of volumetric spatial units.

Fig. 12 illustrates a granted underground 3D volumetric property used as commerce with refined boundaries along with metro entrances, metro surface and metro air outlet in Shenzhen, China. Metro entrances and air outlets are illustrated as concaves and holes, as a result of Boolean operations in order to generate irregular solids and handle multi-components of integrated 3D parcels.

Fig. 13 represents indicative cases of 3D space blocks in 3D space planning.

Fig. 14 illustrates a complex property collection across the surface, which includes five 3D volumetric property units, namely: a metro station, a metro tunnel and underground/above ground commercial properties. The collection of the volumetric spatial units is also presented in a 2D cadastral map, to underline the benefits of 3D registration and visualisation of cadastral objects.

Lastly, use cases from Greece, collecting characteristics of different



Fig. 9. Busway with a section of tunnel below it in Brisbane, Queensland, Australia.

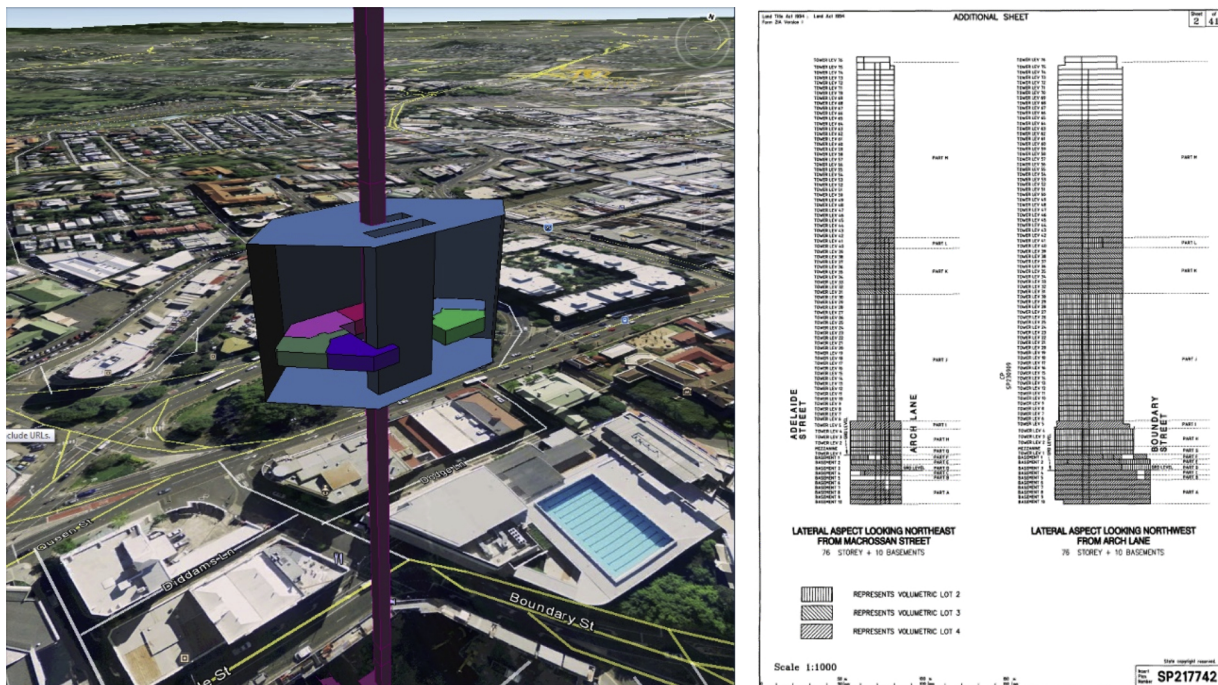

Fig. 10. Soleil building in Brisbane in 3D representation and its 2D cross-section.

spatial units are also analysed. Specifically, a subway station, a metro tunnel and a Special Real Property Object (SRPO) are presented in the figure below. SRPO is a very common 3D case found in Greek islands where land parcels and buildings are partially or totally overlapping to each other. In Fig. 15, a longitudinal section of a subway station in Thessaloniki's metro line 1 which is under construction is presented (Kitsakis et al., 2017).

Similarly, Fig. 16 illustrates a metro tunnel for line 4 extension in Athens, which is under construction.

Last but not least, SRPOs are properties built above or below other properties, usually found on the Greek islands. Customary law applies to mostly in the Aegean islands creating complex RRRs, mixed-up in multiple layers below or above the surface (Kalogianni, 2015). Fig. 17 presents an "Anogi", a common case with overlapping, high-level constructions built, which are bridging paths.

In this context, it can be summarised that some generic 3D use cases

- identified in various jurisdictions worldwide, independently whether title-based or deed-based systems apply - can be grouped according to some characteristics. Such use cases are: "simple" 3D parcels, underground networks and network utilities (such as tunnels and pipelines), spatial planning zones, archaeological spaces and zones, air and marine parcels, as well as collections of complex spatial units that apply under different legislations (e.g. SRPOs). The aim of the proposed spatial profiles is to provide a modelling approach for the different types of use cases, as they have been presented in Section 4.1.

4.2. Initial categorisation of spatial units

The Land Administration Domain Model (LADM, ISO 19152:2012) categorises the encoding of spatial units as having "Text-Based", "Sketch-Based", "Point-Based", "Line-Based", "Polygon-Based", "Topology-Based" level encoding. There is also a division of spatial

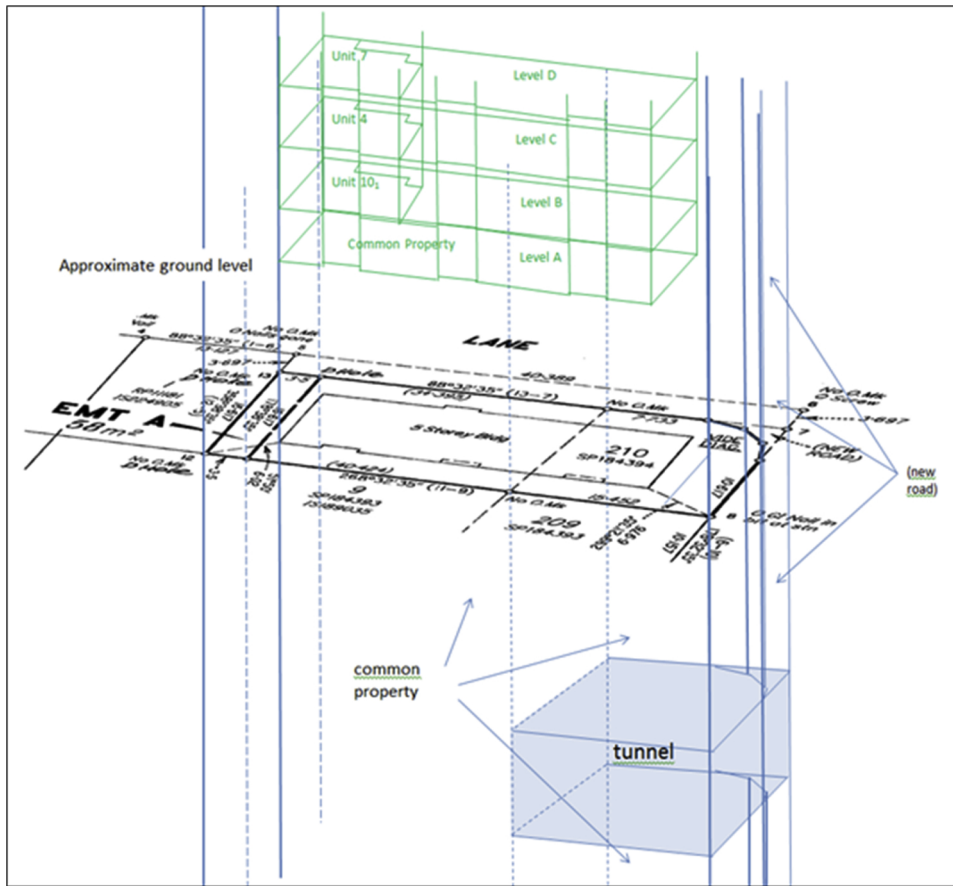

Fig. 11. Side view of a complex case study in Queensland, Australia (Thompson et al., 2016).

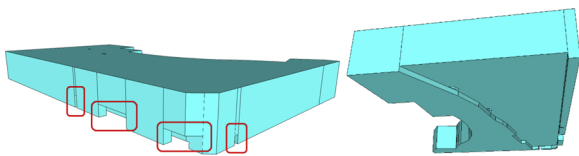

Fig. 12. Underground 3D volumetric property in Shenzhen, China.

units in terms of the legal definition – into “building format” spatial units where the boundary of the unit is defined by the walls of a building, and the “pure volume” where the boundaries are fiat and defined by metes and bounds (Thompson et al., 2015, 2019).

In this context, Thompson et al. (2015) suggested a categorisation of spatial unit types for the purpose of counting and estimating the level of complexity of spatial units. These were named as: “2D Spatial Units”, “Above / Below a Depth or Height” (semi-open spatial units), “Polygonal Slice”, “Single-Valued Stepped Slice”, “Multi-Valued stepped

Slice”, and “General 3D Parcels”. These categories have been used in discussing approaches to representing and storing spatial unit information, but in the current discussion, a variation of the categories is used – more in keeping with the current subject.

Fig. 18 illustrates use cases of the different types of spatial units’ categories, as described above.

4.3. Spatial profile for building/construction format spatial units

In the case of a building/construction format spatial unit, where its boundaries are legally defined by the extents of an existing or planned structure that contains/will contain the unit, there are two ways to describe and spatially represent the spatial unit: by referring to a building format or by defining its actual shape by geometrical types (Fig. 19). The actual geometric form of building/construction format spatial units is variable, mainly being polygonal slices, but all categories are possible.

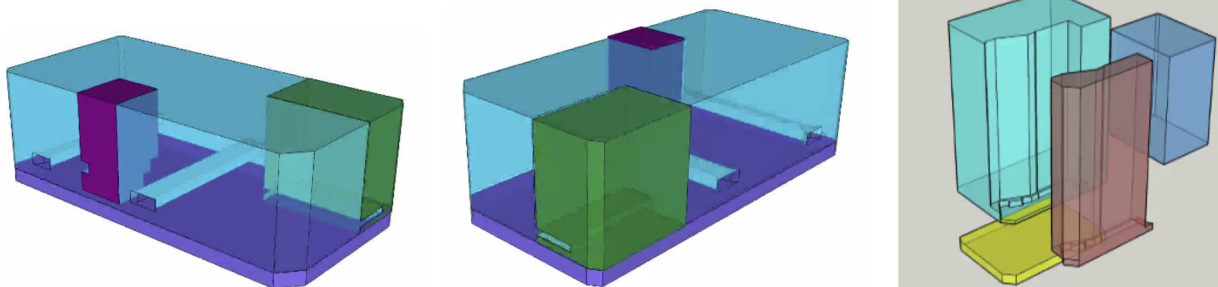

Fig. 13. 3D space blocks in Shenzhen, China.

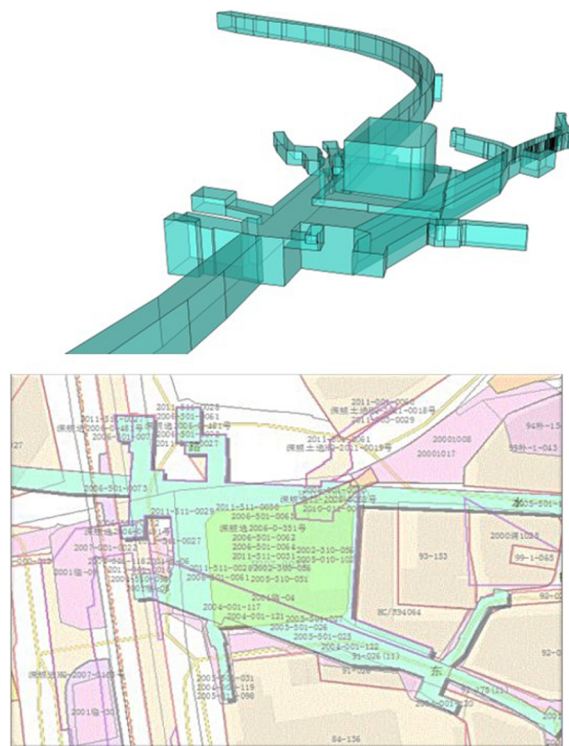

Fig. 14. Collection of volumetric property units in Shenzhen, China.

Thus, in the proposed profile, both options are included by introducing new attributes. When the building/construction format spatial unit is defined by geometry types two attributes are added, similar to the profile for “simple” 3D spatial units: *upper_elevation* and *lower_elevation* defining the horizontal bounded surfaces. Similarly, the constraint $upper_elevation > lower_elevation$ is imposed to prevent the two surfaces to intersect and also to be stored appropriately. At the class *GeneralBoundary_SpatialUnit*, which is a specialisation of *LA_SpatialUnit*, the value of dimension attribute is fixed to “3D”.

Moreover, to represent the reference to a building format, an association with an external class representing the building format is added. This external class needs further, refined modelling and as a future step it should be modelled considering approaches of integrating LADM with models encoding the fine detail of the units, as the recent research regarding integration of LADM with IFC classes, (Atazadeh et al., 2017; Oldfield et al., 2017); encoding information through surveying plans (described with LandXML (Karki et al., 2011); building module of CityGML through CityGML-LADM ADE (Gózdź et al., 2014) which should be defined depending on the Level of Detail (LoD) of the building, etc. In this scene, further modelling of existing *ExtPhysicalBuildingUnit* class should be investigated, in order to be used as an external class at the proposed spatial profile for the association with a building format spatial unit.

4.4. Spatial profile for general spatial unit

This profile aims to cover almost all 3D geometric objects, however complex. Those are still defined in terms of a footprint polygon, and an *upper_elevation* and *lower_elevation*, but in this case the elevations do not define the corresponding upper and lower bounded surfaces; they just provide a limitation on the extent for searching and potentially low LoD presentation. In addition, there will be a collection of *LA_BoundaryFace* objects (further referred as faces) to define the exact extents of the spatial unit. For the general spatial unit, two simplified spatial profiles are proposed, one in a topological model (Fig. 20) and the other in a polygonal encoding (Fig. 21). It is noted, that those

profiles are kept as simple as possible and will be further explored in relation to real-world use cases. A case of general spatial unit is presented in Fig. 22.

In Fig. 22, face string FS_1 (which is an instance of the LADM class *LA_BoundaryFaceString*) defines the boundary separating A and B from C, D and E. In a topological encoding, it would be stored only once, with a plus link to A and B, and a minus link to C, D and E. Likewise face F_1 , which again stands for an instance of the LADM class *LA_BoundaryFace* (which has a hole in it), has a plus link to C, and a minus link to D (as does face F_2).

4.5. Spatial profile for single-valued stepped spatial units

Single-valued stepped spatial units (Fig. 23) are a special case of a general 3D spatial unit (as presented in Section 4.4), in terms of the database storage. Modelling of this type of spatial unit is simplified – as it is relatively simple to allow the data preparation officer to omit all vertical faces – only needing to encode the footprint polygon and the horizontal faces. The data capture program can then, easily generate the vertical faces.

Note that the division into upper surface faces and lower surface faces does not need to be imposed on the storage schema, being a simple matter of the orientation of the faces (clockwise from above for the lower faces, anticlockwise from above for the upper faces). In addition, this class of spatial unit is very easy to visualise in a 2D viewing package.

4.6. Spatial profile for multi-valued stepped spatial units

Similarly to the single-valued stepped spatial units, this is a special case of a general 3D spatial unit (see Section 4.4). Those spatial units are defined by a set of boundary faces, all of which are all either horizontal or vertical, without a restriction of the volume to being single valued in z. This allows volumes with “caves” or “tunnels” in the wall. For encoding purposes, it may be useful to consider the face objects to be divided into upper and lower surface definitions.

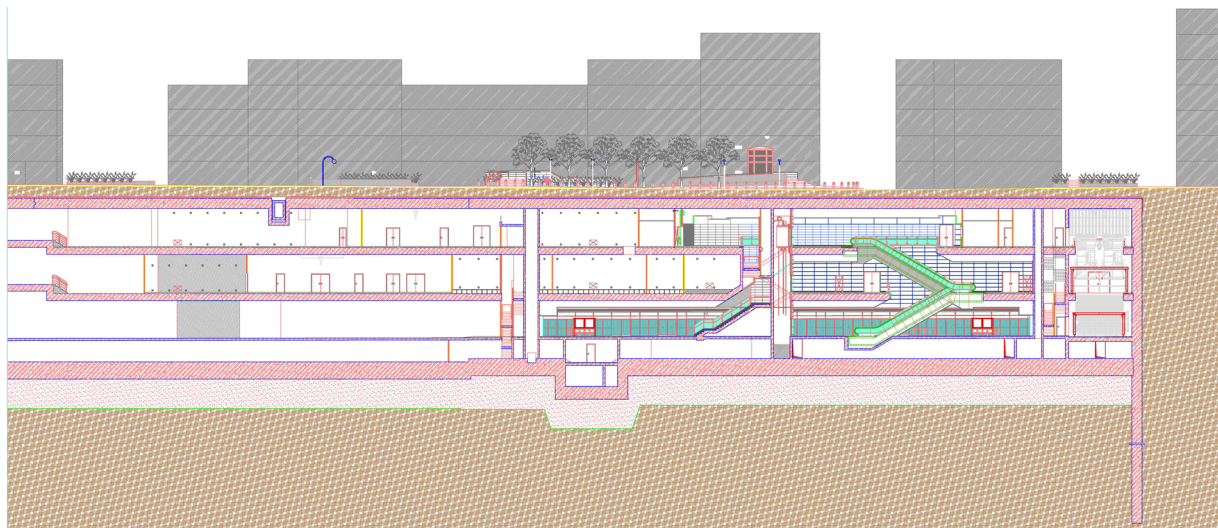

Fig. 15. Longitudinal section of subway station, in Thessaloniki, Greece.

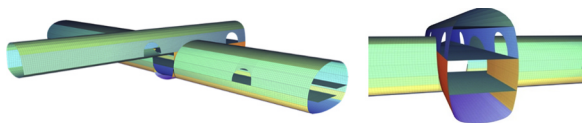

Fig. 16. Metro tunnel, in Athens, Greece.

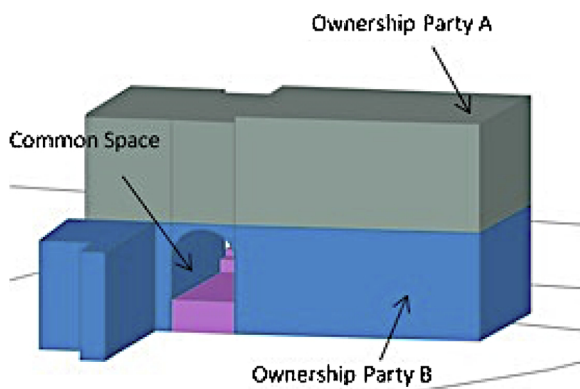

Fig. 17. Special Real Property Object (SRPO) in Aegean islands, Greece.

In Fig. 18, schema D, illustrates an example of a multi-valued stepped spatial unit.

4.7. Spatial profile for balance spatial units

There are two strategies to model this type of spatial units: a) they can be explicitly stored as being the balance of a spatial unit when the sub units are excised – thus requiring the accessing software to determine the shape and detailed definition of the object; and b) the balance spatial unit can be stored in the same form as any general spatial unit (thus, modelled implicitly and avoid redundancy). It is relatively easy to use a spatial subtraction operation to generate a balance object – taking the enclosing object and subtracting all the enclosed objects.

Given this background, it was decided to choose the first approach and model the balance spatial units as the “remainder” between a ‘normal’ 2D and 3D parcel, as depicted in Fig. 24. It is evident that the remainder parcel is not an independent one, and thus its spatial profile depends on the spatial profile of the core/basic 3D parcel. A link between the (‘normal’) 2D parcel and the 3D parcel is created, which is

considered to be a ‘safer’ way to connect the two parcels, in a sense that it shows an explicit warning that the party does not own the whole 3D column, but a part of it, while there is no dependency on an implicit relationship.

At a conceptual level this association can be derived, and it is modelled in this way, while at the implementation level it can be decided whether it would be explicitly or implicitly modelled. The spatial profile of this type of spatial units is quite simple, however depending on the way the 2D parcel is implemented (using one of the spatial profiles presented in Sub Section 3.1), new constraints may be imposed. For instance, the association can become explicit when the 2D parcel is described by simple text (2D text based spatial profile) or points (2D point based spatial profile).

4.8. Reflexion on the modelling approach of 3D spatial profiles

The concept of modelling spatial profiles for the 3D spatial units is summarised in this Section. Based on characteristics of the categorisation of the spatial units, the following principles have been implemented to the categories of the taxonomy, adapted each time to their requirements:

- “Footprint polygon”

As a foundation it is proposed to have a “footprint polygon” or a set of (vertical) face string for each spatial unit, as introduced by Thompson et al. (2017). In that way, a 3D spatial unit is represented by a footprint, which is then restricted by faces above and below the actual parcel.

The concept of having a “footprint polygon”:

- provides a simple 2D limitation on the extent of the unit;
- makes a simpler connection between 2D and 3D spatial units;
- in a non-topological storage structure, it can be stored as a polygon, thus allowing 2D indexing at the database;
- in a topological structure, the face string network can be stored as a 2D planar graph;
- in any case, a set of vertical boundaries for all spatial units opens the database to query and update (even) using 2D software.

I. Bounded surfaces

A spatial unit may not be fully bounded. Talking about 3D spatial units, they will normally have vertical faces and a top and/or bottom

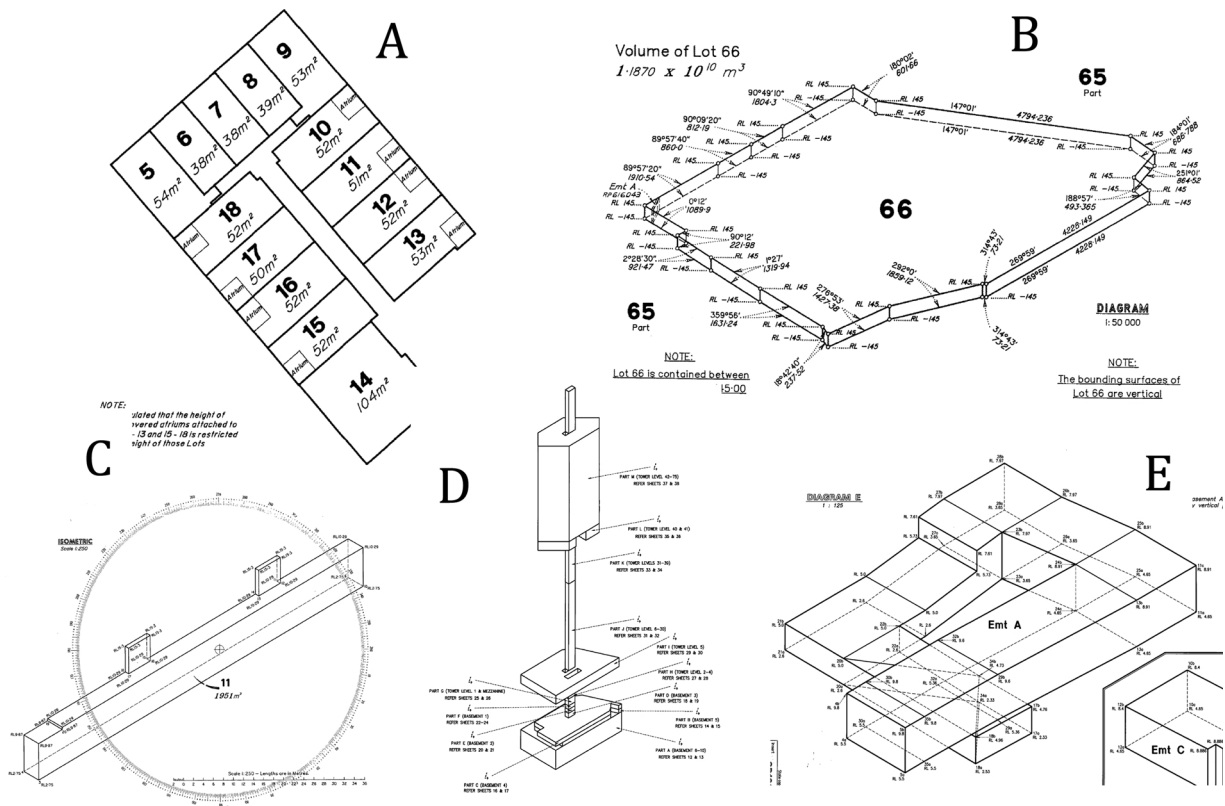

Fig. 18. Subcategories of spatial unit geometries: A. Building Format spatial units; B. Simple Slice; C. Single-valued stepped spatial unit; D. Multi-valued stepped slice; E. General 3D spatial unit.

face(s). Thus, a set of faces that indicates the surfaces above and below the spatial unit (upper and lower surface) to be included in all the spatial profiles, indirectly indicating the maximum and minimum Z value. Associated constraints will be imposed, and multiplicity will be appropriately defined.

I. Absolute or relative height

An attribute defining the absolute height of the spatial unit is proposed to be included as an optional attribute in the spatial profiles. Moreover, a reference to a relative height will be included to describe 3D parcels.

I. Surface relation attribute

The indicator LA_SurfaceRelationType is used to define that the “upper elevation is relative to ground” or the “lower elevation is relative to ground”, as a spatial unit could be defined as “...from 20 m below to 20 m above local ground surface”. This could probably apply to the z values on faces that define a more complex geometry. In the case that the spatial unit has z value(s) relative to ground, it would be rather hard to make the boundary between 2 adjacent 3D spatial units work out the topology on.

I. Reference to a topographic object

A reference to the topographic object is proposed to be included in the spatial profile to specify one or more 3D boundary surfaces, through an association with the external registration.

I. Reference to another surface

Depending on the categorisation they fit into, several spatial units

are defined (partially or completely) referring to another surface. To realise this relationship, an association to this surface - whether it is the earth surface, another spatial unit, etc. - is proposed to be created.

5. Conclusions and future work

Land is at the basis of society. As cities grow in size and population, harmony among their spatial, social and environmental aspects becomes of paramount importance. Particularly for urbanised areas, administration of land is challenged by unprecedented demand for space use above and below earth’s surface, resulting in an increasing spatially complex built environment (including constructions on, above and below earth’s surface; utilities, etc.), where relationships in vertical space can no longer be ambiguously represented in 2D. For that reason, cadastral and land administration organisations around the world are taking steps forward to register multi-level property rights in a way that provides clearer insight of the legal situation. “3D Cadastre”, being used both as buzzword and technical term to indicate the urgent need for change in the development and management of Rights, Restrictions and Responsibilities and their spatial extent in 3D, is discussed in this paper, while the progress that has been made in advancing this concept with the adoption of LADM as ISO standard is also underlined. What is more, in the context of the LADM revision, which is explicitly described in Section 2, attention is given to the 3D support of LADM in terms of modelling, storing, visualising and maintaining the spatial units, as well as at the future integration with technical standards and application schemas.

Special attention was given to the need to combine independent systems, methodologies and procedures associated with different disciplines, aspects and scales of the built environment, by introducing the concept of the spatial development lifecycle and the key role of land administration in it. In this context, spatial profiles can efficiently support a holistic lifecycle thinking and enhance the interoperability

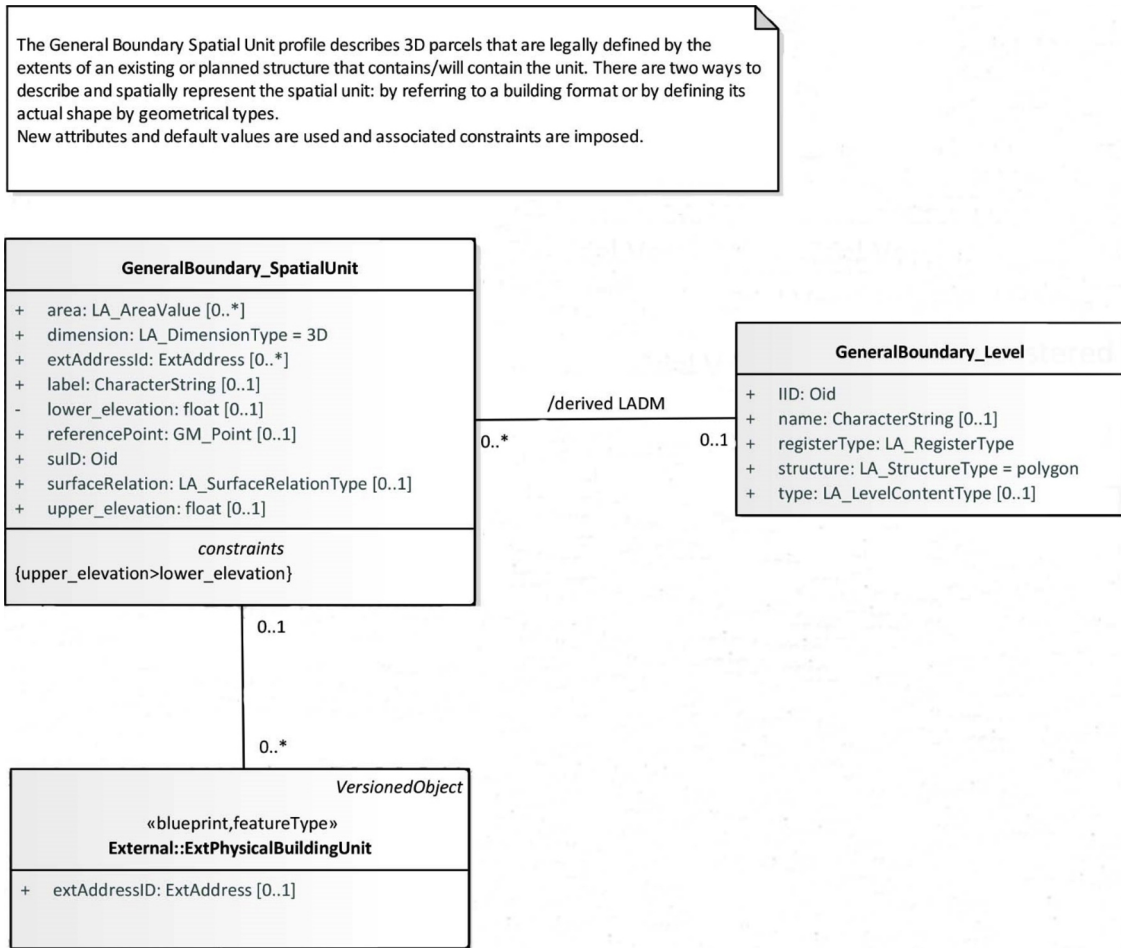

Fig. 19. Proposed spatial profile for building/construction format spatial units (Kalogianni et al., 2018b).

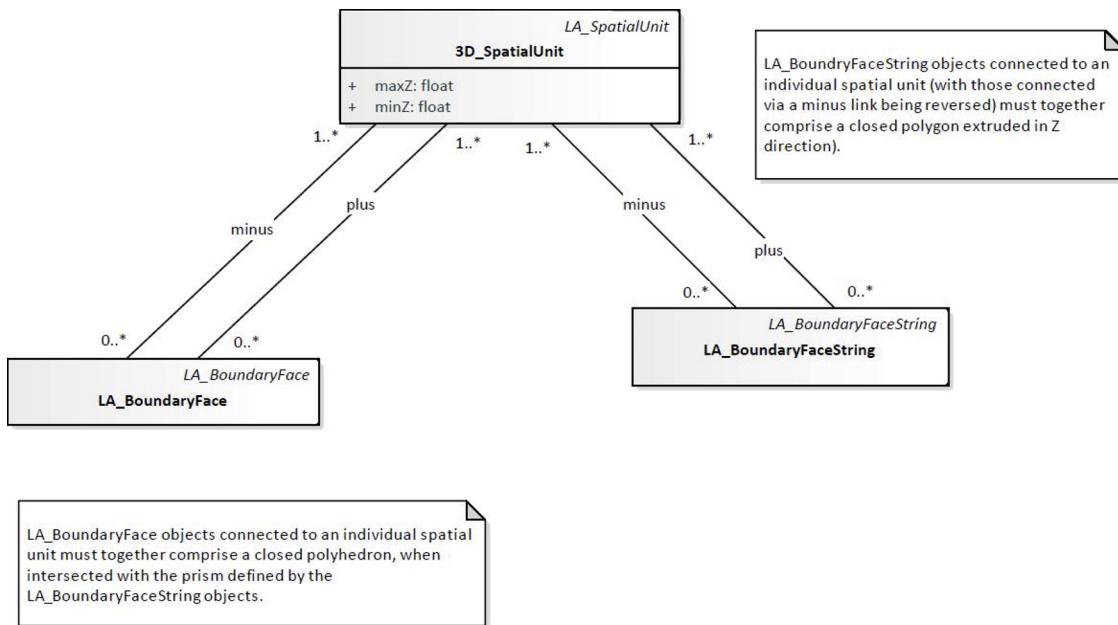

Fig. 20. Spatial profile of a general spatial unit in a topological model (simplified).

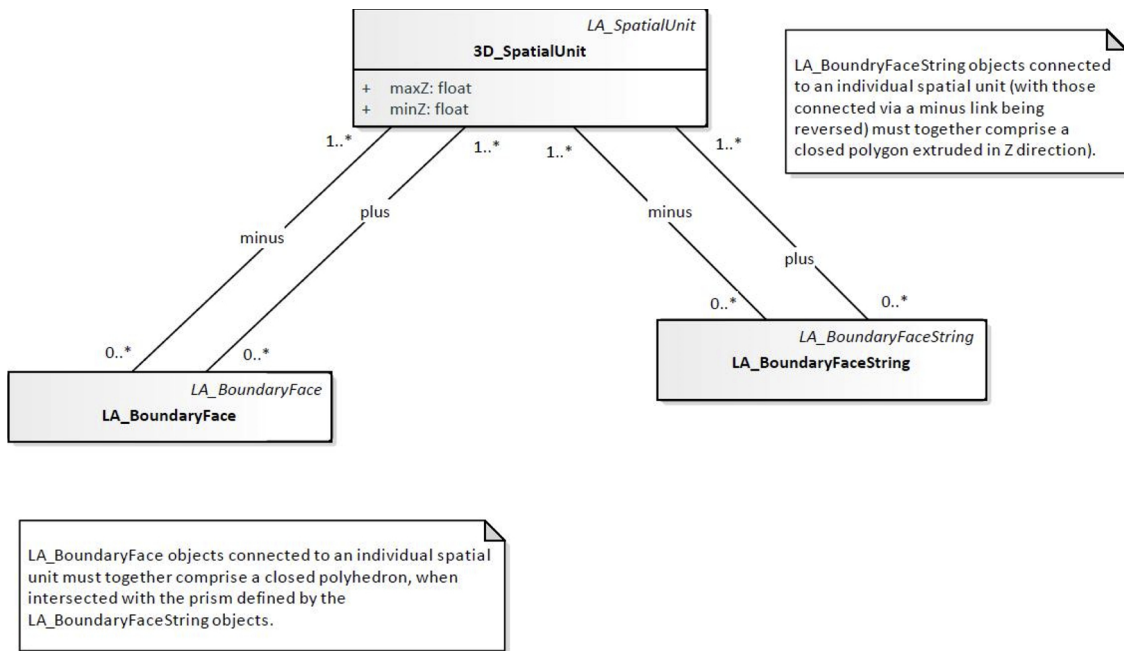

Fig. 21. Spatial profile of a general spatial unit in a polygonal encoding (simplified).

between the different phases and disciplines. The spatial profiles that have been developed in the context of LADM Edition I are described in this paper, while Section 4 is dedicated to present proposed spatial profiles for the Edition II of LADM, based on an inventory of general use cases that can be found in various jurisdictions, as well as the revised taxonomy of spatial units that has initially been presented by Thompson et al. (2015).

The proposed spatial profiles in the context of LADM revision and the modelling approach that has been followed, will initiate a discussion on the modelling, usage and encoding of spatial profiles considering the need to adopt a holistic approach. Collaboration with organisations that are involved in LADM revision process and will benefit from the development of spatial profiles and encodings is the next step (e.g. IHO, OGC, etc.). What is more, as a further step of this research, the

proposed spatial profiles can be examined in contrast and enriched with the spatial profiles that have been developed in China, as part of their national implementation strategy.

Furthermore, future actions include among others, the investigation of different encoding models concerning the further detailed technical specification of LADM based on standards, such as: BIM/IFC, GML, CityGML, LandXML, InfraGML, IndoorGML, RDF/linked data, GeoJSON, INTERLIS. For each profile, the model(s) that can better support its implementation should be investigated. It is underlined that it is very important to establish a link between BIM and land administration in relation to spatial planning and lifecycles of constructions/buildings, considering that in the future, cadastral data may originate from design phase/ process (e.g. BIM/IFC data).

Moreover, as a future step, more methods of volumetric

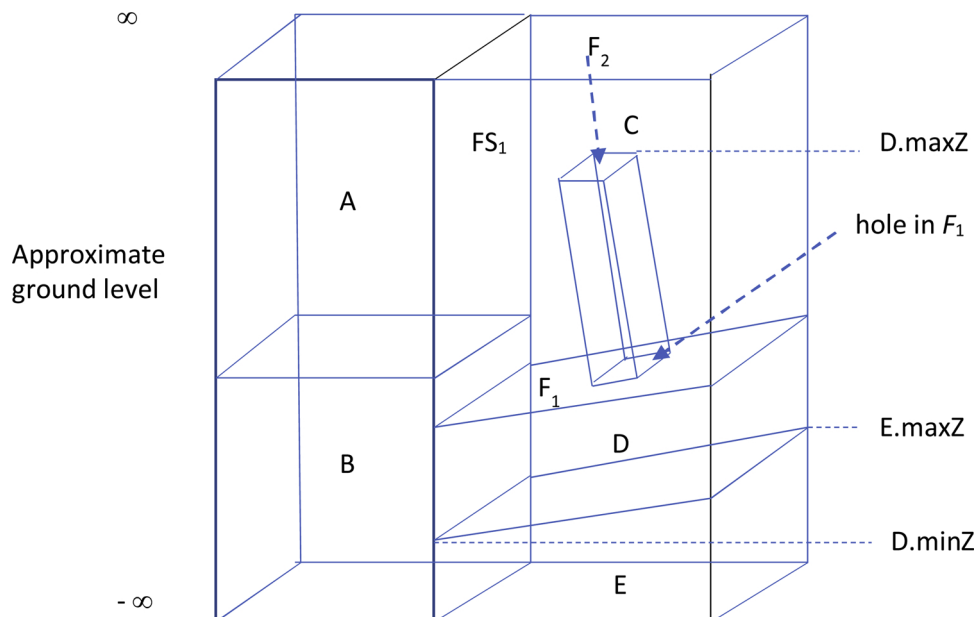

Fig. 22. Faces and Face Strings – Showing two simple spatial units A and B, a general spatial unit D (which includes the air-shaft to above the surface, and two balance spatial units C and E which are open above and below respectively).

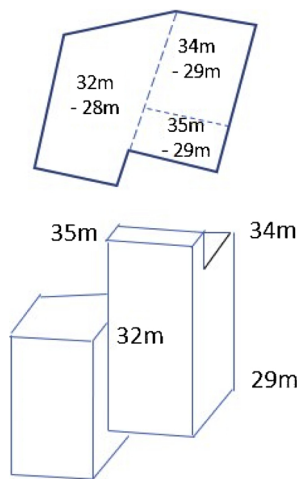

Fig. 23. Single-valued stepped spatial unit (Kalogianni et al., 2018b; annotated).

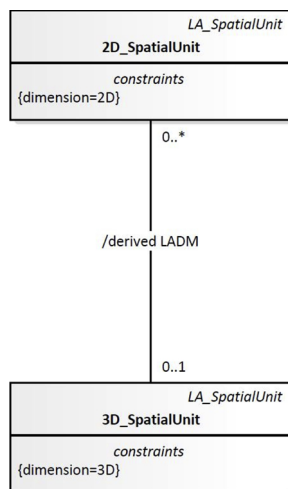

Fig. 24. Spatial profile for the balanced spatial unit.

representation that are used to create 3D objects, apart from current assumption of vector/boundary representation-based spatial units should be investigated. Specifically, data derived by architectural or other drawings leading to Constructive Solid Geometry or sweep representations should be observed, improving the link to CAD/BIM models. Additionally, it should be considered whether boundaries represented through voxels or point clouds, photos or pictometry can be supported. Similarly, for the curved boundaries there are many categories possible that should be identified, such as patches from cylinder, sphere, ellipsoid, NURBS, etc. Besides, the “LA_BoundaryFace” class does not provide attributes to semantically distinguish various types of boundaries and it can be further explored based on the above-mentioned in the revision of the standard.

Last but not least, deep integration of space and time resulting in 4D geometry/topology should be included in further investigation and as a next step corresponding spatial profiles should be designed.

References

Alattas, A., Zlatanova, S., Van Oosterom, P., Chatziniolaou, E., Lemmen, C., Li, K.-J., 2017. Supporting indoor navigation using access rights to spaces based on combined use of IndoorGML and LADM models. *ISPRS Int. J. Geoinf.* 6, 384.

Aien, A., Kalantari, M., Rajabifard, A., Williamson, I., Bennett, R., 2013. Utilizing data modelling to understand the structure of 3D Cadastres. *J. Spat. Sci.* (58), 215–234 2013.

Atazadeh, B., Kalantari, M., Rajabifard, A., Champion, T., Ho, S., 2016. Harnessing BIM for 3D Digital Management of Stratified Ownership Rights in Buildings. *FIG Working Week 2016: Recovery from Disaster*, Christchurch, New Zealand 2-6 May 2016.

Atazadeh, B., Rajabifard, A., Kalantari, M., 2017. Assessing performance of three BIM-Based views of buildings for communication and management of vertically stratified legal interests. *ISPRS Int. J. Geoinf.* (6), 198 2017.

Çağdaş, V., Kara, A., van Oosterom, P., Lemmen, C.H.J., İşikdag, Umit., Kathmann, R., Stubkjaer, E., 2016. An initial design of ISO 19152:2012 LADM based valuation and taxation data model. In: Dimopoulou, E., van Oosterom, P. (Eds.), *Proceedings of the 11th 3D Geoinfo Conference*, 20-21 October 2016, Athens, Greece. Peer rEviewed Annals, Volume IV-2/W1. *ISPRS*, pp. 145–154 2016. ISSN: 2194-9050.

Çağdaş, V., Kara, A., İşikdağ, Ü., van Oosterom, P.J.M., Lemmen, C.H.J., 2017. A knowledge organization system for the development of an ISO 19152:2012 LADM valuation module. In: *Proceedings of FIG Working Week 2017*. 29 May - 2 June 2017, Helsinki, Finland.

Dimopoulou, E., Karki, S., Roić, M., de Almeida, J.P.D., Griffith-Charles, C., Thompson, R., Ying, S., Paasch, J., van Oosterom, P.J.M., 2018. Initial Registration of 3D Parcels. (Chapter 2 - FIG Publication (2018) 3D Cadastres Best Practices – Extended Version, Editor: Van Oosterom, P.J.M.).

DNRM, 2016. Queensland Government, Department of Natural Resources and Mines, Cadastral Survey Requirements, Version 7.1.

FAO, 2012. Voluntary Guidelines on the Responsible Governance of Tenure of Land, Fisheries and Forests in the Context of National Food Security (VGGT). Available online: <http://www.fao.org/docrep/016/i2801e/i2801e.pdf> (Last accessed: 1 May 2019).

FIG, 1995. The FIG Statement on the Cadastre. ISBN 0-644-4533-1.

FIG, 2018a. In: *Proceedings 7th Land Administration Domain Workshop*, Zagreb, Croatia, 11-13 April 2018. Editors: Christiaan Lemmen, Peter Van Oosterom & Elfriede Fendel. ISBN 978-87-92853-69-1. International Federation of Surveyors FIG. Copenhagen, Denmark. Available online: <https://wiki.tudelft.nl/bin/view/Research/ISO19152/LADM2018Workshop>.

FIG, 2018b. Best practices 3D cadastres - extended version. In: Oosterom, Peter van (Ed.), *International Federation of Surveyors*. Copenhagen, Denmark, March 2018 (ISBN 978-87-92853-64-6, ISSN: 2311-8423), Available online: http://www.fig.net/resources/publications/figpub/FIG_3DCad/FIG_3DCad-final.pdf. (Last accessed: 12 January 2019).

GLTN/UN Habitat/Kadaster, 2015. Fit-For-Purpose Land Administration – Guiding Principles. UNHABITAT/ GLTN, Nairobi, Kenya. Available online: https://www.fig.net/news/news_2016/2016_07_gltnguide/fit-for-purpose-land-adm-guidingprinciples-for-country-implementation.pdf. (Last accessed: 12 January 2019).

Gózdź, K., Pachelski, W., van Oosterom, P.J.M., Coors, V., 2014. The possibilities of using CityGML for 3D representation of buildings in the cadastre. In: *Proceedings of the 4th International Workshop on 3D Cadastres*. 9-11 November 2014, Dubai, United Arab Emirates. pp. 339-362. ISBN 978-87-92853-28-8.

Guo, R., Luo, F., Zhao, Z., He, B., Li, L., Luo, P., Ying, S., 2014. The Applications and Practices of 3D Cadastre in Shenzhen. 4th International Workshop on 3D Cadastres. 9-11 November 2014. United Arab Emirates, Dubai, pp. 339–362.

Habitat, I.I.I., 2016. New Urban Agenda (NUA). Available online: <http://habitat3.org/the-new-urban-agenda/>. (Last accessed: 10 February 2019).

International Organisation for Standardisation, 2012. ISO 19152:2012, Geographic Information—Land Administration Domain Model (LADM); ISO, Geneva, Switzerland. 2012. Available online: <https://www.iso.org/standard/51206.html> (Last accessed on 12 February 2019).

International Organisation for Standardisation, 2011. ISO 19156:20121, Geographic Information—Observations and Measurements. ISO, Geneva, Switzerland. Available online: <https://www.iso.org/standard/32574.html> (Last accessed on 27 March 2019).

Kalogianni, E., 2015. Design of a 3D Multipurpose Land Administrative System for Greece in the Context of Land Administration Domain Model (LADM). National Technical University of Athens (NTUA), Athens, Greece Master's Thesis, 2015.

Kalogianni, E., Dimopoulou, E., Quak, W., Germann, M., Jenni, L., van Oosterom, P.J.M., 2017. “INTERLIS language for modelling legal 3D spaces and physical 3D objects by including formalized implementable constraints and meaningful code lists” *ISPRS Int. J. Geoinf.* 6 (10), 319 Special Issue: Research and Development Progress in 3D Cadastral Systems. 2017.

Kalogianni, E., Dimopoulou, E., van Oosterom, P.J.M., 2018a. 3D cadastre and LADM: needs and expectations towards LADM revision. In: 7th International FIG Workshop on the Land Administration Domain Model. 12-13 April 2018, Zagreb, Croatia.

Kalogianni, E., Dimopoulou, E., Thompson, R., Lemmen, C.H.J., van Oosterom, P.J.M., 2018b. Investigating 3D spatial unit's as basis for refined 3D spatial profiles in the context of LADM revision. In: 6th International FIG 3D Cadastre Workshop. 2-4 October 2018, Delft, The Netherlands.

Kara, A., Çağdaş, V., Lemmen, C., İşikdag, U., van Oosterom, P.J.M., Stubkjaer, E., 2018. Supporting fiscal aspect of Land administration through a LADM-based valuation information model. In: 2018 World Bank Conference on Land and Poverty. Washington DC, March 19-23., The World Bank.

Karki, S., Thompson, R., McDougall, K., Cumerford, N., van Oosterom, P., 2011. ISO Land administration domain model and LandXML in the development of digital survey plan lodgement for 3D cadastre in Australia. In: van Oosterom, P., Fendel, E., Stoter, J., Streilein, A. (Eds.), 2nd International Workshop on 3D Cadastres, 16-18 November 2011. Delft, The Netherlands. pp. 65–84.

Kitsakis, D., Paasch, J.M., Paulsson, J., Navratil, G., Vučić, N., Karabin, M., Tenório Carneiro, A.F., El-Mekawy, M., 2016. 3D Real property legal concepts and cadastre: a comparative study of selected countries to propose a Way forward. In: 5th International FIG 3D Cadastre Workshop. 18-20 October, Athens, Greece.

- Kitsakis, D., Dimopoulou, E., 2017. Addressing public law restrictions within a 3D cadastral context. *ISPRS Int. J. Geoinf.* 6 (6), 182–2017.
- Lemmen, C.H.J., 2012. A Domain Model for Land Administration. Ph.D. Thesis. Delft University of Technology, Delft, The Netherlands.
- Lemmen, C.H.J., van Oosterom, P.J.M., Kalantari, M., Unger, E.M., Teo, C.H., de Zeeuw, K., 2017. Further Standardisation in Land Administration. 2017 World Bank Conference on Land and Poverty. The World Bank, Washington DC March 20-24, 2017.
- Lemmen, C.H.J., van Oosterom, P.J.M., Kalantari, M., 2018. Towards a New working item proposal for edition II of LADM. In: Proceedings of the 7th International FIG Workshop on the Land Administration Domain Model 11-13 April 2018. Zagreb, Croatia, International Federation of Surveyors, Copenhagen, Denmark. pp. 331–354. https://wiki.tudelft.nl/pub/Research/ISO19152/LADM2018Workshop/21-22_LADM_2018.pdf.
- Oldfield, J., van Oosterom, P.J.M., Beetz, J., Krijnen, T.F., 2017. Working with open BIM standards to source legal spaces for a 3D cadastre. *ISPRS Int. J. Geoinf.* 6 (10), 351–2017.
- Paasch, J.M., van Oosterom, P.J.M., Lemmen, C.H.J., Paulsson, J., 2015. Further modelling of LADM's rights, restrictions and responsibilities (RRRs). *Land Use Policy* 49.
- Penninga, F., van Oosterom, P.J.M., 2008. A simplicial complex-based DBMS approach to 3D topographic data modelling. *Int. J. Geogr. Inf. Sci.* 22, 751–779.
- Scarponcini, P., 2017. Code List Manifesto. OGC Pending document, 17-050r1, 2017-09-04.
- Shnaidman, A., van Oosterom, P.J.M., Abdul Rahman, A., Karki, S., Lemmen, C.H.J., Ploeger, H., 2019. Analysis of the Third FIG 3D Cadastres Questionnaire: Status in 2018 and Expectations for 2022. FIG Working Week 2019 - Geospatial Information for a Smarter Life and Environmental Resilience. Hanoi, Vietnam, April 22–26. .
- Stoter, J.E., Ledoux, H., Zlatanova, S., Biljecki, F., 2016. Towards Sustainable and Clean 3D Geoinformation.
- Stoter, J.E., Ploeger, J., Roes, R., van der Riet, E., Biljecki, F., Ledoux, H., Kok, D., Kim, S., 2017. Registration of multi-level property rights in 3D in the Netherlands: two cases and next steps in further implementation. *ISPRS Int. J. Geoinf.* 6 (6), 158–2017.
- Stubkjær, E., Paasch, J.M., Çağdaş, V., van Oosterom, P.J.M., Simmons, S., Paulsson, J., Lemmen, C.H.J., 2018. International code list management – the case of Land administration. In: Proceedings of the 7th International FIG Workshop on the Land Administration Domain Model 11-13 April 2018. Zagreb, Croatia, International Federation of Surveyors, Copenhagen, Denmark. pp. 223–244. Available online: https://wiki.tudelft.nl/pub/Research/ISO19152/LADM2018Workshop/15-05_LADM_2018.pdf.
- Thompson, R.P., Oosterom, van, Karki, P.J.M.S., Cowie, B., 2015. A Taxonomy of Spatial Units in a Mixed 2D and 3D Cadastral Database. FIG Working Week 2015. Sofia, Bulgaria. .
- Thompson, R.P., van Oosterom, P.J.M., Soon, K.H., 2016. Mixed 2D and 3D survey plans with topological encodings. In: Proceedings of the 5th International FIG 3D Cadastre Workshop. Athens, Greece, October 18-20.
- Thompson, R., van Oosterom, P.J.M., Soon, K.H., 2017. LandXML encoding of mixed 2D and 3D survey plans with multi-level topology. *ISPRS Int. J. Geoinf.* 6 (6), 171. <https://doi.org/10.3390/ijgi6060171>. 2017.
- Thompson, R.J.P., van Oosterom, P.J.M., Karki, S., 2019. Towards an implementable data schema for 4D/5D cadastre including Bi-temporal support. In: FIG Working Week 2019. Hanoi, Vietnam.
- UN ECOSOC and African Union, 2016. Facing the Challenges of Land Monitoring in the Framework and Guidelines on Land Policy in Africa – Towards Agenda 2063 and the 2030 Agenda for Sustainable Development. (Last accessed: 10 April 2019). <https://repository.uneca.org/handle/10855/23503>.
- Habitat/GLTN, U.N., 2017. Sourcebook for Operationalisation of Global Land Indicators. Global Land Indicators Initiative (GLII) Working Paper Number 4. Nairobi. (Last accessed: 10 April 2019). <http://mirror.glt.n.net/index.php/land-tools/glt-land-tools/global-land-indicators-initiativegltii>.
- UNGGIM, 2018. A Guide to the Role of Standards in Geospatial Information Management. Available online: http://ggim.un.org/meetings/GGIM-committee/8th-Session/documents/Standards_Guide_2018.pdf. (Last accessed: 10 December 2018). .
- UNGGIM, 2019a. Fundamental Geospatial Data Themes. Available online: <https://undesa.maps.arcgis.com/apps/Cascade/index.html?appid=4741ad51ff7a463d833d18cbcec29fff>. (Last accessed: 10 January 2019). .
- van Oosterom, P.J.M., 2013. Research and development in 3D cadastres. 3D cadastres II, special issue, computers. *Environment and Urban Systems* 40, 1–6.
- van Oosterom, P.J.M., 2019. Part and Parcel of City Development. FIG Update, March. .
- van Oosterom, P.J.M., Kara, A., Kalogianni, E., Shnaidman, A., Indrajit, A., Alattas, A., Lemmen, C.H.L., 2019. Joint ISO/TC211 and OGC Revision of the LADM: Valuation Information, Spatial Planning Information, SDG Land Indicators, Refined Survey Model, Links to BIM, Support of LA Processes, Technical Encodings, and Much More on Their Way! FIG Working Week 2019 - Geospatial Information for a Smarter Life and Environmental Resilience. Hanoi, Vietnam, April 22–26. .
- World Bank, 2018. Indicators. Available online: <https://data.worldbank.org/indicator> (Last accessed: 28 December 2018). .
- Ying, S., Guo, R., Li, L., van Oosterom, P.J.M., Stoter, J., 2015. Construction of 3D volumetric objects for a 3D cadastral system. *Trans. Gis* 19 (5), 758–779. <https://doi.org/10.1111/tgis.12129>.
- Ying, S., Guo, R., Yang, J., He, B., Zhao, Z., Jin, F., 2017. 3D space shift from CityGML LoD3-Based multiple building elements to a 3D volumetric object. *ISPRS Int. J. Geoinf.* 6 (6), 17–2017.
- Zulkifli, N.A., Abdul Rahman, A., van Oosterom, P.J.M., 2015. An overview of 3D topology for LADM-based objects. The International Archives of the Photogrammetry, Remote Sensing and Spatial Information Sciences XL-2/W4 <https://doi.org/10.5194/isprsarchives-XL-2-W4-71-2015>. 2015.