

## Impact factors of influence zones when shallow tunnelling

Vu, M.N.; Broere, Wout; Bosch, Johan

**Publication date**

2016

**Document Version**

Accepted author manuscript

**Published in**

Proceedings of the International conferences on earth sciences and sustainable geo-resources development -ESASGD 2016

**Citation (APA)**

Vu, M. N., Broere, W., & Bosch, J. (2016). Impact factors of influence zones when shallow tunnelling. In *Proceedings of the International conferences on earth sciences and sustainable geo-resources development -ESASGD 2016*

**Important note**

To cite this publication, please use the final published version (if applicable). Please check the document version above.

**Copyright**

Other than for strictly personal use, it is not permitted to download, forward or distribute the text or part of it, without the consent of the author(s) and/or copyright holder(s), unless the work is under an open content license such as Creative Commons.

**Takedown policy**

Please contact us and provide details if you believe this document breaches copyrights. We will remove access to the work immediately and investigate your claim.



# ESASGD 2016

Short name of the parallel conference IPE (2016) 000-000

Conference Title: International Conference on Advances in Mining and Tunnelling (ICAMT 2016)

## Impact factors of influence zones when shallow tunnelling

Minh Ngan Vu<sup>a,b,1</sup>, Wout Broere<sup>a</sup>, Johan W. Bosch<sup>a</sup>

<sup>a</sup>Delft University of Technology, Delft, the Netherlands

<sup>b</sup>Hanoi University of Mining and Geology, Hanoi, Vietnam

---

### Abstract

The extent of the influence zone affected by tunnelling depends on the amount of over-excavation and stress changes induced in the soil, normally represented as a value of volume loss. This paper combines upper and lower estimates of volume loss for different soil conditions and cover-to-diameter ratios in order to identify the zones around the tunnel influenced by tunnelling. These zones are combined with risk categories of damage of existing buildings in order to identify whether applying mitigating methods or taking additional control measures during tunnelling would be needed for a safe and damage-free tunnel construction. The influence of soil parameters on the influence zones is also investigated to identify their impact and quantity of the requirements for mitigating measures.

*Keywords:* Influence zone; Shallow tunnelling

---

### 1. Introduction

One of the obstacles in the development of shallow tunnels in urban areas is the high risk of damage on existing nearby buildings. Although the areas where nearby structures are impacted were estimated in the studies of Kaalberg et al. (2005) and Selemetas et al. (2005), which are based on analyses of empirical data, theoretical understanding on the extent of influence zones induced by tunnelling is still limited.

As Vu et al. (2015a) pointed out, the extent of influence zones, which were estimated as a preliminary assessment of the risk of damage of existing buildings, significantly depends on the volume loss produced in tunnelling. From research of Attewell and Farmer (1974), Cording and Hansmire (1975) and Mair and Taylor (1999), the volume loss in tunnelling process can be estimated as the total of volume loss at the tunnelling face, along the shield, at the tail and behind the shield tail. According to Vu et al. (2015b), the total volume loss  $V_L$  in tunnelling is given by:

$$V_L = V_{L,f} + V_{L,s} + V_{L,t} + V_{L,c} \quad (1)$$

where  $V_{L,f}$  is volume loss at tunnelling face,  $V_{L,s}$  is volume loss along the shield,  $V_{L,t}$  is volume loss at the tail, and  $V_{L,c}$  is volume loss due to consolidation (Fig. 1).

Fig. 2 shows the relationship between the total volume loss  $V_L$  and C/D ratios when tunnelling in clay derived in Vu et al. (2015b). There are the boundaries of the total volume loss  $V_L$  when tunnelling has just finished (not taking into account the consolidation) (Fig. 2a) and when including consolidation effects (Fig. 2b).

---

<sup>1</sup> \* Corresponding author. Tel.: +31 15 278 1930; fax: +31 15 278 1189  
E-mail address: N.Vuminh@tudelft.nl; vuminhngan@khoaxaydung.edu.vn.

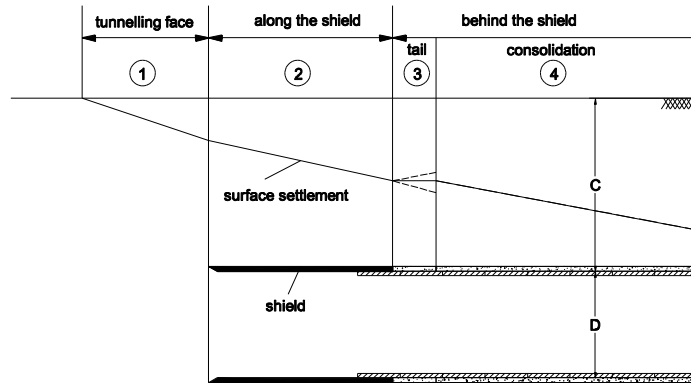

Fig. 1. Volume loss components (Vu et al., 2015b)

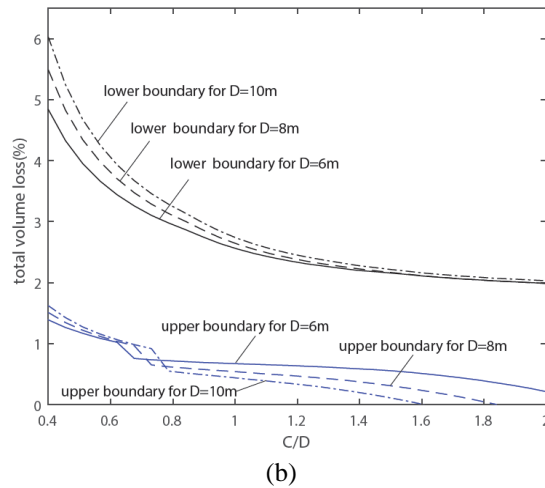
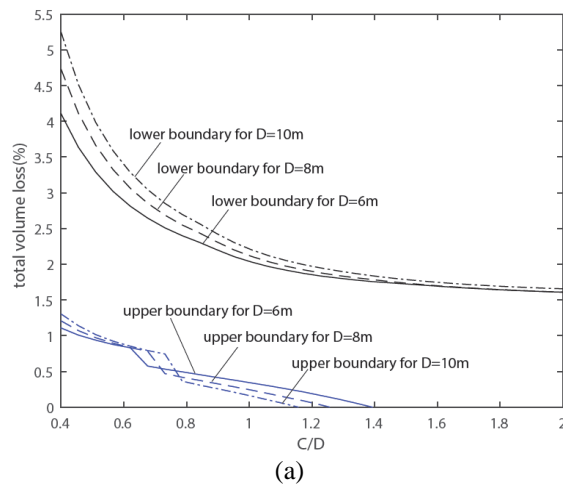

Fig. 2. Total volume loss for tunnelling in clay with various diameter D (Vu et al.,2015b)

(a) not including consolidation; (b) including consolidation

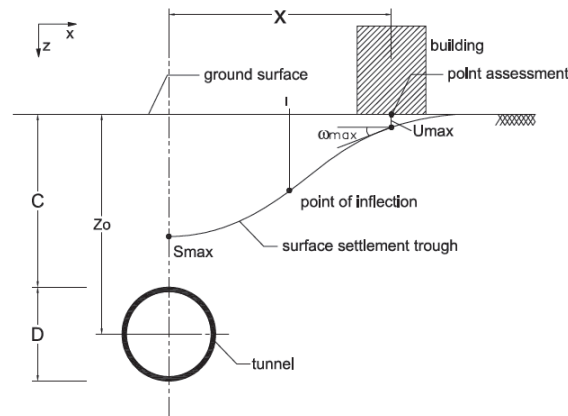

Fig. 3. Tunnel and existing surface building (Vu et al., 2015a)

Table 1. Typical values of maximum building slope and settlement for damage risk assessment (Rankin, 1988)

Risk Category	Maximum slope of building	Maximum settlement of building (mm)	Description of risk
1	Less than 1/500	Less than 10	Negligible; superficial damage unlikely
2	1/500 – 1/200	10-50	Slight; possible superficial damage which is unlikely to have structural significance
3	1/200 – 1/50	50-75	Moderate; expected superficial damage and possible structural damage to buildings, possible damage to relatively rigid pipelines
4	Greater than 1/50	Greater than 75	High; expected structural damage to buildings. Expected damage to rigid pipelines, possible damage to other pipelines

In the assessment of the impact of tunnelling on existing nearby structures, the responses of buildings due to tunnelling have been investigated by many authors (Rankin, 1988; Boscardin and Cording, 1989; Mair et al., 1996; Burland et al., 2001; Franzius, 2004; Netzel, 2009; Giardina, 2013). In design, this assessment has been majorly based on risk categories proposed by Rankin (1988), Boscardin and Cording (1989), and Mair et al. (1996). In investigating the relationship between ground movements and the  $C/D$  ratio, Vu et al. (2015a) applied an allowable settlement  $u_{max} = 10\text{mm}$  and slope  $\omega_{max} = 1/500$  as proposed in Table 1 by Rankin (1988). These deformation limits of buildings are also suitable for the preliminary assessment in the three-stage methodology for the assessment of risk of building damage induced by bored tunnelling indicated in Mair et al. (1996) and Burland et al. (2001). The influence zones for surface and subsurface settlements were also derived in the analysis of Vu et al. (2015a).

In order to estimate the impact of volume loss and the extent of influence zones in relation to the different damage categories, this paper focuses on the boundaries between categories, for example  $u_{max} = 10, 50$  and  $75\text{mm}$  for categories 1,2 and 3, respectively.

To estimate the extent of the influence zone on the surface due to tunnelling, the model in Fig. 3 was used by Vu et al. (2015a). The distance  $x$  from the tunnel axis to the buildings corresponding with settlement  $u_{max}$  is given by:

$$x = \sqrt{-2i^2 \ln \left( \frac{u_{max}}{S_{v,max}} \right)} = \sqrt{-2i^2 \ln \left( \frac{u_{max} i 4 \sqrt{2}}{V_L D^2 \sqrt{\pi}} \right)} \quad (2)$$

The relationship between the relative influence distance from the tunnel axis to the buildings  $x/D$  and  $C/D$  ratios was derived. Fig. 4 shows an example in the case of a tunnel with diameter  $D = 6\text{m}$  in cohesive soil with an allowable settlement  $u_{max} = 10\text{mm}$  and various volume loss  $V_L$ . The area inside the curve represents the zone where allowable settlements are exceeded and the tunnel is too close to the building. In the case of 1% volume loss, a width of the influence zone of approximate  $1.2D$  is found for a tunnel with  $C/D \approx 2$ . With 1.5% volume loss, a width of the influence zone is of nearly  $1.7D$  with  $C/D \approx 3.5$ . For deep tunnels, the settlement trough at the surface becomes wider, less deep and less steep and therefore it limits the impact on existing buildings. Meanwhile, in the case of shallower tunnels, the settlement trough becomes steeper but as the tunnel is close to surface the extent of affected zone is also less wide, limiting the impact on buildings.

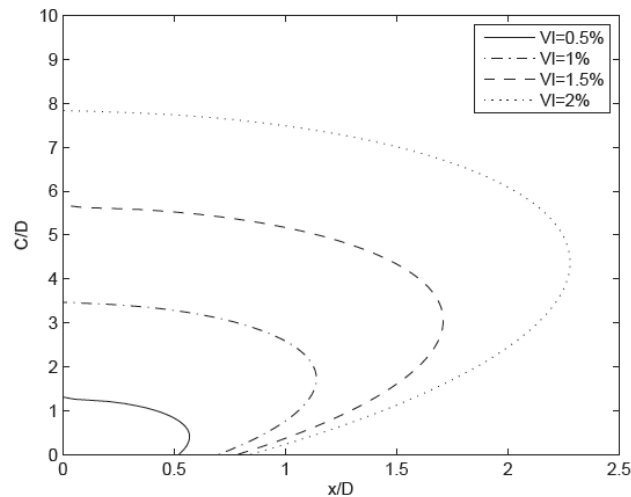

Fig. 4. Relationship between  $x/D$  and cover-to-depth  $C/D$  ratios in the case of tunnel with  $D = 6\text{m}$  in cohesive soil and the allowable settlement  $u_{\max} = 10\text{mm}$  (Vu et al., 2015a)

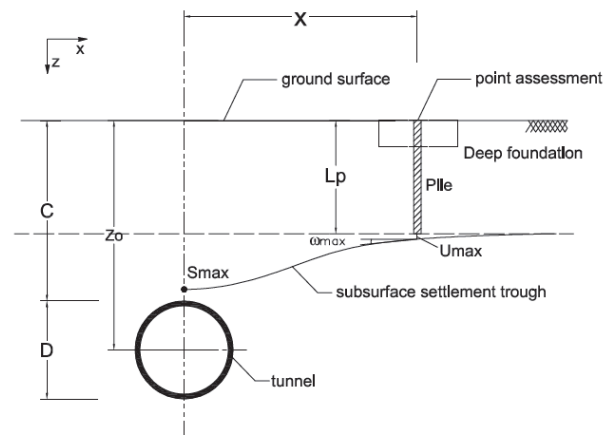

Fig. 5. Tunnel and exiting subsurface structures (Vu et al., 2015a)

In order to estimate the impact of tunnelling on piles and pile toes, Kaalberg et al. (2005) carried out a data analysis of a trial test at the Second Heinenoord Tunnel and indicated that the safe distance between the piles and tunnels should be at least  $0.5D$ . Piles close to the tunnel would have their tip bearing capacity and/or their shaft friction impacted by the volume loss. The influence zones induced by tunnelling were also estimated in the study of Selemetas et al. (2005) based on the monitoring data of the response of full scale piles in the construction of the new Channel Tunnel Rail Line in the UK. Three influence zones determined by Selemetas et al. (2005) in the correlation between the settlement of the pile tips and ground settlements are in a good agreement with the study of Kaalberg et al. (2005). However, the influenced zones in these studies were identified in particular projects with the same  $C/D$  ratio of approximate 1.9 and a pile-length-to-diameter ratio  $L_p/D > 1$ .

In the investigation of subsurface ground movements induced by shallow tunnelling, Vu et al. (2015a) proposed a model as shown in Fig. 5. Subsurface influence zones were estimated for a combination of volume loss and allowable settlement  $u_{\max}/V_L$  as shown in Fig. 6 and for different tunnel diameters and  $C/D$  ratios as shown in Fig. 7. The ratio  $u_{\max}/V_L$  is adopted, where for example  $u_{\max}/V_L = 1\text{m}$  corresponds to a typical case of  $u_{\max} = 10\text{mm}$  and  $V_L = 1\%$ . From Fig. 6, the shallower the tunnel is and the lower the volume loss  $V_L$  is, the narrower the influence zone is. It can be seen that the influence zones becomes narrower towards surface in Fig. 7. The influence zones are also in the line with the extent of zone A (with the width of approximate  $1D$  directly above tunnel) in the case studies in Kaalberg et al. (2005) and Selemetas et al. (2005).

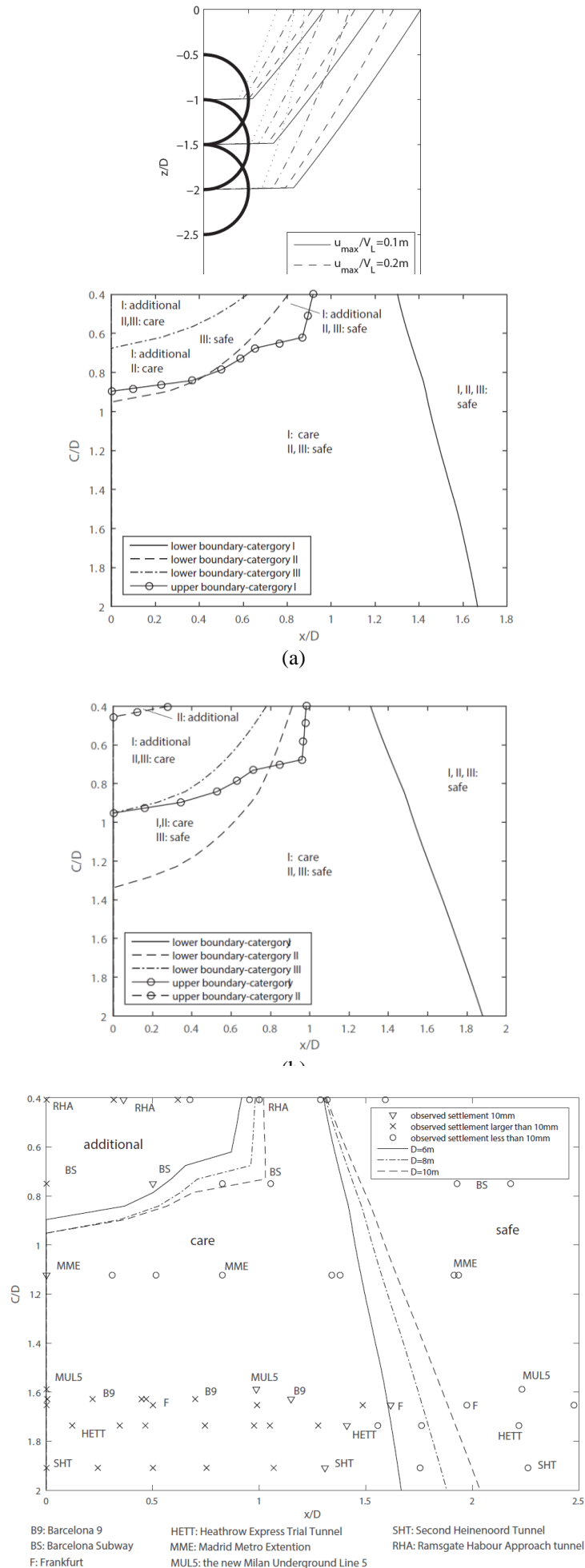

Fig. 10. Comparison of relative influence distances to shallow tunnelling cases

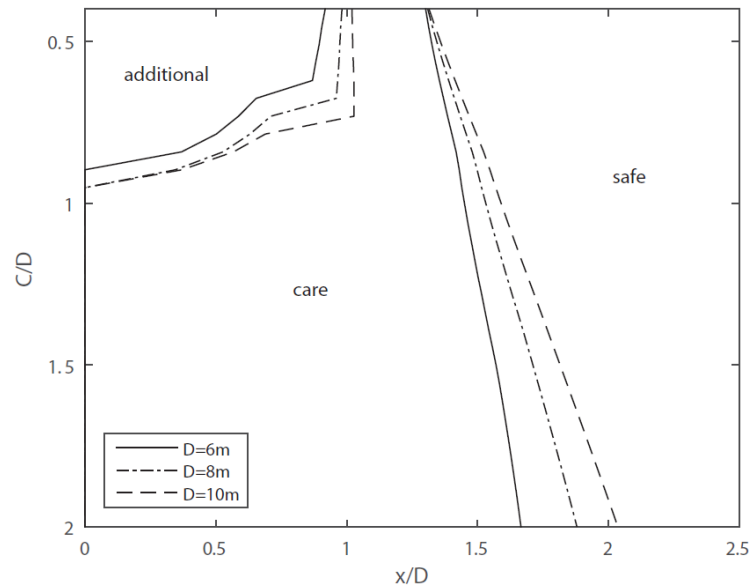

Fig. 9. Relative influence distances due to tunnelling in clay for risk category I with various tunnel diameter  $D$

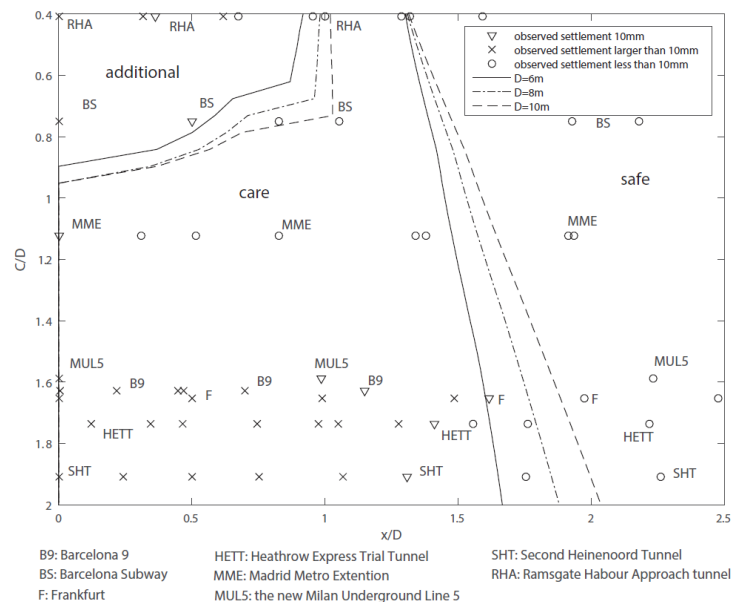

Fig. 10. Comparison of relative influence distances to shallow tunnelling cases

Fig. 9 shows the effects of tunnel diameters on the relative influence distances due to tunnelling in clay for risk category I. In the case of  $C/D = 0.4$  (the lowest  $C/D$  ratio value in this study), if buildings are at a relative influence distance  $x/D$  less than 0.8, ground treatment should be implemented. When the  $C/D$  ratio ranges from 0.8 to 2, careful monitoring is required during the tunnelling progress. In the case of  $C/D$  ratios larger than 1, surface buildings will normally deform less than  $u_{\max} = 10\text{mm}$ . As long as the TBM is properly operated, from this figure, it can also be seen that even if the buildings are directly above the tunnel, ground improvement methods may not be necessary for tunnelling with an allowable settlement  $u_{\max} = 10\text{mm}$  with the  $C/D$  ratio larger than 1.

However, when the relative influence distance  $x/D$  is less than 2, careful control is necessary. In order to apply these results to shallow tunnelling, they should be compared to data observed from existing tunnelling cases. The validation of the impact of shallow tunnelling on ground movement in soft soils is shown in Fig. 10 for relative influence distances from the tunnel axis to the existing surface buildings. The observed settlement data in shallow tunnelling cases described in Table 2 are taken from surface settlement trough data. Since there is only a small number of existing tunnels which have  $C/D$  values lower than 2 and detailed surface settlement monitoring data in order to validate, the discussion here will provide recommendations for future shallow tunnelling.

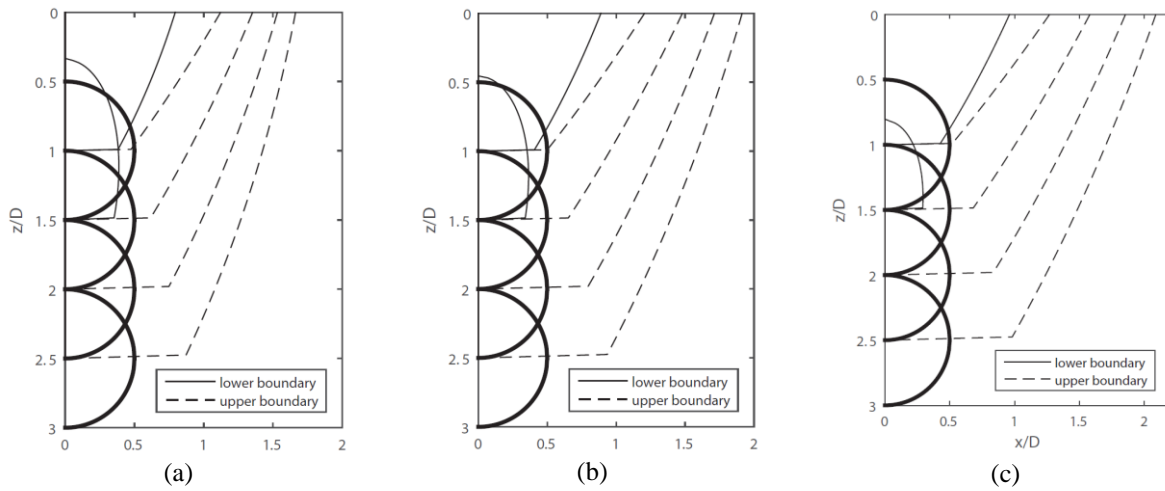

Fig. 11. Influence zones when shallow tunnelling in clay

(a)  $D = 6\text{m}$ ; (b)  $D = 8\text{m}$ ; (c)  $D = 10\text{m}$ 

Fig. 12. Comparison of shallow tunnelling influence zones for the Barcelona Line 9 case

- In Fig. 10, the cases with observed settlements of more than 10mm are derived from measuring points at or nearby the vertical axis of the tunnel where the surface settlements reach the maximum values as indicated in Vu et al.(2015a). Settlements further away from the tunnel axis in these projects, but still in the zone requiring attention are equal or less than 10mm.

- Settlements of approximate 10mm are almost always recorded in the zone indicating special care for projects where ground improvement methods were used and in the normally safe areas in the case of the Frankfurt and Heathrow tunnels, which were constructed without ground improvement.

- For settlements less than 10mm, there are two observed cases, namely the Barcelona Subway and the Madrid Metro Extension where ground improvement methods were applied and followed with careful monitoring. In the areas that additional measures are needed, Ramsgate Harbour Approach tunnel was constructed by Perforex pre- vaulting method combined with the fiberglass ground improvement methods (Bloodworth, 2002). This tunnel has a C/D ratio of 0.41, but is not strictly a bored tunnel.

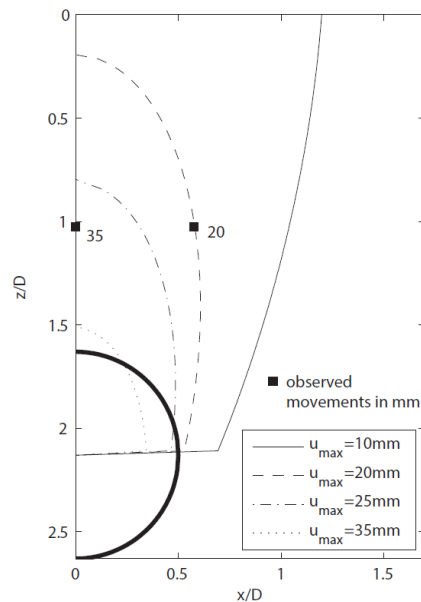
In the investigation of subsurface influence zones, Fig. 11 shows the boundaries of the subsurface zones influenced by tunnelling in clay in the cases of  $C/D = 0.5, 1, 1.5$  and  $2$  with diameters  $D = 6, 8,$  and  $10\text{m}$  and an allowable settlement  $u_{\max} = 10\text{mm}$  in risk category I. In this zone, which is determined by lower and upper boundaries, careful control and monitoring is required when tunnelling. If subsurface structures appear in the zone from lower boundaries to tunnel axis, ground improvement methods are necessary.



Table 2. Distance x to tunnel center axis corresponding to settlement  $u_{\max} = 10\text{mm}$  in shallow tunnelling cases

Tunnel	D(m)	C/D	u(mm)	x(m)	x/D	Construction method	Soil type	Ground improvement	Reference
Barcelona Line 9	9.4	1.63	10.8	1.149	9.4	EPB machine	Miocene material	jet grouting compensation, structural jacking	Gens et al.(2011)
			11.096	3	1.14				
			14.944	6.846	0.73				
			17.897	7.185	0.76				
			20.582	3.338	0.36				
			22.371	0.057	0.01				
			17.43						
Barcelona Subway	8	0.75	0,240	1	2,179	-	Stiff clay with gravel	Jet grouting	Ledesma and Romero (1997)
			0,338	15,41	1,927				
			1,285	6,61	0,826				
			1,492	8,438	1,055				
			10	4	0.5				
Frankfurt	6.5	1.65	3.0	19.27	2.965	Shield with bolted concrete segments	Frankfurt clay marl	-	Rowe and Kack (1983)
			4.85	19.11	2.479				
			7.8	12.82	1.972				
			10	10.5	1.615				
			12.8	9.652	1.48				
			20.9	6.433	0.99				
			28.6	3.257	0.5				
			32.1	0	0				
Heathrow Express Trail Tunnel, UK	8.5	1.735	0.91	27.64	3.25	Open face	Stiff clay	-	Deane and Bassett(1995)
			2.83	18.87	2.22				
			5.82	14.98	1.76				
			8.19	13.22	1.56				
			10	12	1.41				
			12.54	10.85	1.28				
			16.54	8.93	1.05				
			18.71	8.29	0.9				
			26.65	6.33	0.75				
			34.34	3.97	0.47				
Madrid Metro Extension	8.88	1.12	0.57	17.2	1.94	EPB machine	Stiff tertiary layers	-	Gonzalez and Sagaseta(2001)
			1.4	17	1.9				
			2.15	12.6	1.4				
			4.63	11.9	1.4				
			4.85	7.34	0.83				
			7.38	4.56	0.51				
			8.72	2.76	0.31				
			10	0	0				
Milan Underground Line 5	6.7	1.59	0.322	21	3.134	EPB machine	Coarse-grained soil	Grout injection	Fargnoli et al.(2013)
			1.611	14.95	2.231				
			10	6.6	0.985				
			21	0	0				
Ramsgate Harbour	11	0.41	0.72	14.51	1.32	Perforex pre-vaulting	Weathered chalk	Fiberglass	Bloodworth(2002)
			1.66	17.5	1.6				

Approach			1.87	11	1	method		
Tunnel			2.65	14.1	1.29			
			4.8	7.4	0.67			
			8.9	10.5	1			
			10	4	0.364			
			11.9	0	0			
			12.5	6.8	0.62			
			13.1	3.5	0.32			
Second	8.3	1.91	1.41	29.2	3.52	Slurry	Cohesive	-
Heinenoord			3	18.77	2.26	machine	Holocence	
Tunnel			5.26	14.56	1.76		layers and	
			10	10.87	1.31		sandy	
			15.1	8.87	1.07		Pleistocene	
			21.8	6.26	0.75		layers	
			26.4	4.154	0.5			
			29.3	2	0.241			
			30.1	0	0			

Netzel (2009)

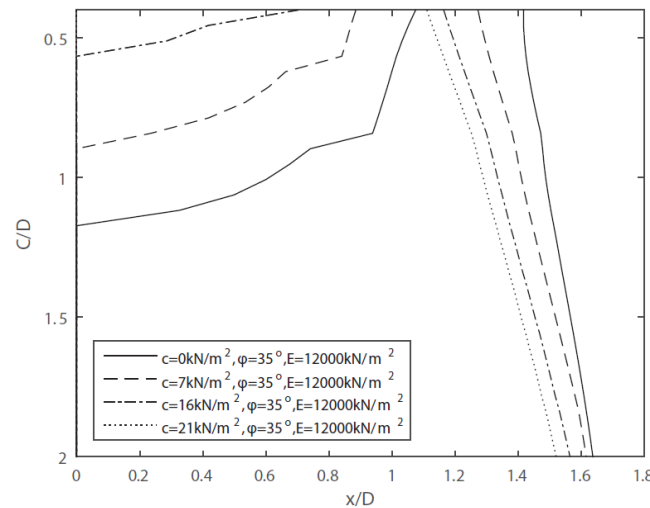

Fig. 13. Effect of cohesion  $c$  on relative influence distance  $x/D$  in the case of tunnelling with  $D = 6m$

The area outside from the upper boundaries is safe for subsurface structures. It is shown that the larger the tunnel diameter is, the larger the influence zone is. Additionally, when the tunnel becomes shallower with a smaller  $C/D$  ratio, the influence zone reduces, the careful control area becomes smaller and the unsafe area becomes larger. From this analysis, designers can decide the  $C/D$  ratio for a particular tunnel with or without adding ground improvement methods to prevent unexpected deformations of existing buildings.

Fig. 12 shows the validation for the subsurface influence zone in the Barcelona 9 case with  $C/D = 1.6$  and  $D=9.4m$  at the level  $-9.5m$  ( $z/D \approx 1$ ). The observed settlement of 20mm at the distance  $x/D = 0.6$  is on the analysis graph. The maximum settlement of subsurface curve is 35mm at the tunnel axis.

### 3. Effects of soil parameters on influence zones

In order to identify the method and quantity of ground improvement that should be applied when tunnelling, the impacts of soil parameters on relative influence distances  $x/D$  are investigated. In this study, the effects of the cohesion  $c$ , the friction angle  $\phi$  and the modulus of elasticity  $E$  on boundaries of influence zones are studied.

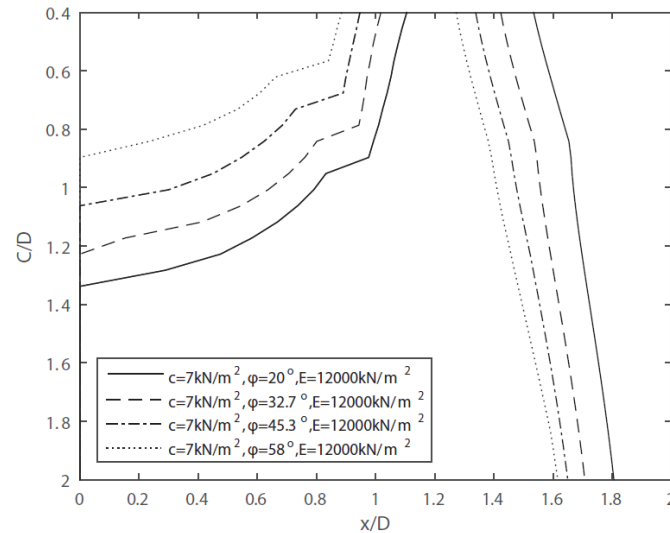

Fig. 14. Effect of friction angle  $\phi$  on relative influence distance  $x/D$  in the case of tunnelling with  $D = 6\text{m}$

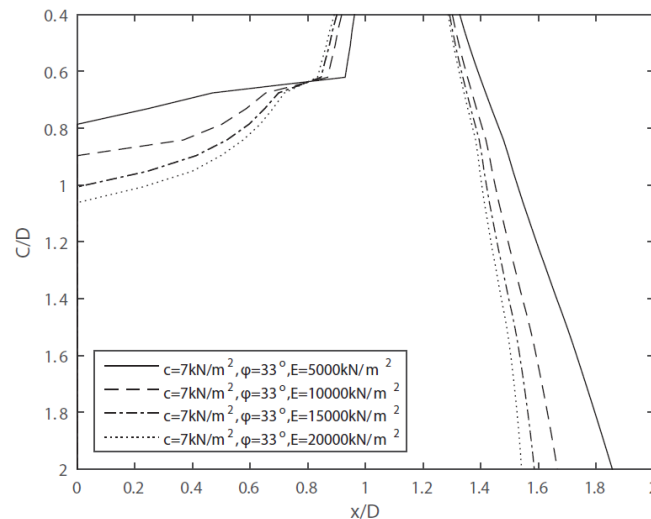

Fig. 15. Effect of modulus of elasticity  $E$  on relative influence distance  $x/D$  in the case of tunnelling with  $D = 6\text{m}$

Fig. 13 shows the dependence of the relative influence distance  $x/D$  on the cohesion  $c$  in the case of tunnelling with  $D = 6\text{m}$  in soil with friction angle  $\phi = 35^\circ$  and elasticity modulus  $E = 12000\text{kN/m}^2$ . When the cohesion  $c$  increases, the unsafe relative distance  $x/D$  decreases. Moreover, it can also be seen that the gaps between lower boundaries are larger than the gaps between upper boundaries. Based on this analysis, in the case of tunnelling with a small  $C/D$  ratio, increasing the value of the cohesion  $c$  can be an effective method in order to reduce the relative influence distance  $x/D$ . When the value of the cohesion  $c$  is approximate  $21\text{kN/m}^2$ , the lower boundary becomes 0 with  $C/D = 0.4$ . It means that if ground treatment methods can improve the cohesion to  $21\text{kN/m}^2$ , the risk of settlements more than  $10\text{mm}$  can be limited, but with careful control on grouting and support pressure still needed.

The effect of the friction angle  $\phi$  on the relative influence distance  $x/D$  is shown in Fig. 14. In this analysis, the friction angle  $\phi$  is assessed in the range from  $20^\circ$  to  $58^\circ$ , which corresponds to the maximum friction angle of a grouted soil (Fujita et al., 1998) for a tunnel in soil with cohesion  $c = 7\text{kN/m}^2$  and elasticity modulus  $E = 12000\text{kN/m}^2$ . It can be seen that when the friction angle  $\phi$  increases, the relative influence distance  $x/D$  becomes smaller. However, due to the limitation of increasing of the friction angle  $\phi$  further, a relative influence distance  $x/D$  will remain. Based on these results, increasing the friction angle  $\phi$  can be a useful method to reduce the relative influence distance  $x/D$ .

Fig. 15 shows an opposite impact of increasing the modulus of elasticity  $E$  on the relative influence distance  $x/D$  due to tunnelling for a tunnel in soil with cohesion  $c = 7\text{kN/m}^2$  and friction angle  $\phi = 33^\circ$ . This figure shows that the higher the value of the elasticity modulus  $E$  is, the larger the relative influence distance  $x/D$  is. This is due to the increasing heave at the tail, which leads to more compensation of the settlement of tunnelling and a

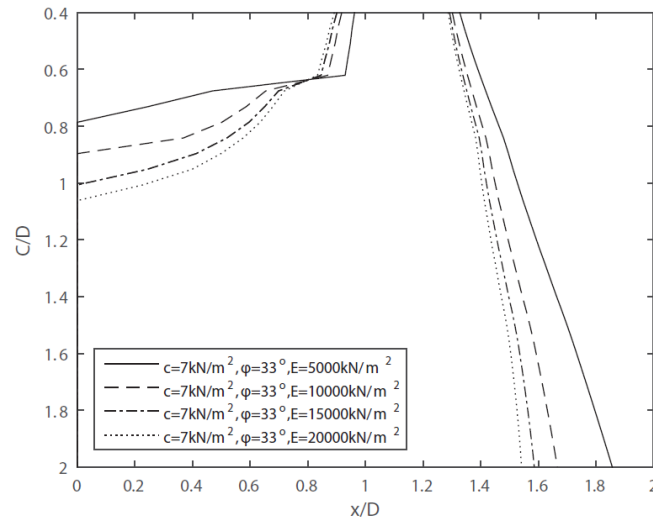

Fig. 16. Combination influence of soil parameters on relative influence distance  $x/D$  in the case of tunnelling with  $D = 6\text{m}$

reduction of the total volume loss. However, in practice, when increasing the cohesion  $c$  value and friction angle  $\phi$  value, the modulus of elasticity  $E$  of the soil also increases. In this case, it follows that the volume loss at the tunnelling face can be reduced but it is difficult to compensate any settlement at the tail.

Fig. 16 shows the relationship between the  $C/D$  ratio and the relative influence distance  $x/D$  in the case of shallow tunnelling with diameter  $D = 6\text{m}$  with the combination of changing all above soil parameters. With a given distance from the existing buildings to the tunnel axis, required soil parameters can be estimated in order to achieve settlements less than a given allowable settlement. It can be seen that although increasing stiffness and strength has opposite impacts on the width of the influence zone, the combination of these effects can lead to a reduction of the influence zone. On the basis of this analysis, designers can choose suitable ground improvement methods and identify quantities of ground treatment, for example, jet grouting, soil mixing and other mitigating measures.

#### 4. Conclusion

By combining the upper and lower estimates of volume loss and ground movement analysis, the boundaries of influence zones induced by shallow tunnelling are derived both for surface and subsurface in this chapter. The combination of influence zones with different categories of risk damage assessment is investigated in order to identify the zones where mitigating measures should be applied or careful monitoring is needed. Although there is a small number of existing case studies, it is a good agreement between the analysis results and observed data. In order to allow tunnelling in areas, which are deemed to lead to too large surface settlements without additional measures (unsafe zones), this chapter also shows that by improving soil properties, the boundaries of influence zones can be controlled. This analysis provides a theoretical basis to identify the mitigating methods and the required quantity of soil improvement with the aim of safe and damage-free tunnel construction.

#### References

- Attewell, P., Farmer, I., 1974. Ground disturbance caused by shield tunnelling in a stiff, overconsolidated clay. *Engineering Geology* 8 (4), 361–381.
- Bloodworth, A. G., 2002. Three-dimensional analysis of tunnelling effects on structures to develop design methods. Ph.D. thesis, University of Oxford.
- Boscardin, M. D., Cording, E. J., 1989. Building response to excavation-induced settlement. *Journal of Geotechnical Engineering* 115 (1), 1–21.
- Burland, J. B., Standing, J. R., Jardine, F. M., 2001. Building response to tunnelling: case studies from construction of the Jubilee Line Extension, London. Vol. 200. Thomas Telford.
- Cording, E. J., Hansmire, W., 1975. Displacements around soft ground tunnels.
- Deane, A. and Bassett, R. (1995). The heathrow express trial tunnel. *Proceedings of the ICE-Geotechnical Engineering*, 113(3):144–156.
- Fargnoli, V., Boldini, D., and Amorosi, A. (2013). TBM tunnelling-induced settlements in coarse-grained soils: The case of the new milan underground line 5. *Tunnelling and Underground Space Technology*, 38:336–347.
- Franzius, J. N., 2004. Behaviour of buildings due to tunnel induced subsidence. Ph.D. thesis, University of London.
- Fujita, Y., Ishimaru, R., Hanai, S., Suenaga, Y., 1998. Study on internal friction angle and tensile strength of plain concrete. *Proceedings of fracture mechanics of concrete structures FRAMCOS 3*, 325–334.
- Gens, A., DiMariano, A., and Yubero, M. (2011). EPB tunneling in deltaic deposits: observations of ground movements. In *7th International Symposium Geotechnical Aspects of Underground Construction in Soft Ground*.
- Giardina, G., 2013. Modelling of settlement induced building damage. Ph.D. thesis, Delft Univ. of Technology, Delft, Netherlands.

- Gonzalez, C. and Sagaseta, C. (2001). Patterns of soil deformations around tunnels. Application to the extension of madrid metro. *Computers and Geotechnics*, 28(6):445–468.
- Kaalberg, F., Teunissen, E., Van Tol, A., Bosch, J., 2005. Dutch research on the impact of shield tunnelling on pile foundations. In: *Proceeding of the International Conference on Soil Mechanics and Geotechnical Engineering*. Vol. 16. AA Balkema Publishers, p. 1615.
- Ledesma, A. and Romero, E. (1997). Systematic backanalysis in tunnel excavation problems as a monitoring technique. In *Proceedings of the International Conference on Soil Mechanics and Foundation Engineering- International Society for Soil Mechanics and Foundation Engineering*, volume 3, pages 1425–1428. AA Balkema.
- Mair, R., Taylor, R., 1999. Theme lecture: Bored tunnelling in the urban environment. of XIV ICSMFE [131], 2353–2385.
- Mair, R., Taylor, R., Burland, J., 1996. Prediction of ground movements and assessment of risk of building damage due to bored tunnelling. In: *Fourth International Symposium of International Conference of Geotechnical Aspects of on Underground Construction in Soft Ground*. AA Balkema, pp.713–718.
- Netzel, H. D., 2009. Building response due to ground movements. TU Delft, Delft University of Technology.
- Rankin, W., 1988. Ground movements resulting from urban tunnelling: predictions and effects. *Geological Society, London, Engineering Geology Special Publications* 5 (1), 79–92.
- Rowe, R. and Kack, G. (1983). A theoretical examination of the settlements induced by tunnelling: four case histories. *Canadian Geotechnical Journal*, 20(2):299–314.
- Selemetas, D., Standing, J., Mair, R., 2005. The response of full-scale piles to tunnelling. In: *Proceedings of the 5th International Symposium on Geotechnical Aspects of Underground Construction in Soft Ground*. Taylor and Francis, pp. 763–769.
- Vu, M. N., Broere, W., Bosch, J. W., 2015a. Effects of cover depth on ground movements induced by shallow tunnelling. *Tunnelling and Underground Space Technology* 50, 499–506.
- Vu, M. N., Broere, W., Bosch, J. W., 2015b. Volume loss in shallow tunnelling. *Tunnelling and Underground Space Technology*, 59:77–90.