

**Gal/Xgal U/LDB Spectroscopic/Stratospheric THz Observatory:
GUSTO**

Walker, C.; Kusela, C.; Young, A.; Verts, W. ; Gao, J.R.; Hu, Qing; Silva, J. R.G.; Mirzaei, B.; Laauwen, Wouter; More Authors

DOI

[10.1117/12.2629051](https://doi.org/10.1117/12.2629051)

Publication date

2022

Document Version

Final published version

Published in

Millimeter, Submillimeter, and Far-Infrared Detectors and Instrumentation for Astronomy XI

Citation (APA)

Walker, C., Kusela, C., Young, A., Verts, W., Gao, J. R., Hu, Q., Silva, J. R. G., Mirzaei, B., Laauwen, W., & More Authors (2022). Gal/Xgal U/LDB Spectroscopic/Stratospheric THz Observatory: GUSTO. In J. Zmuidzinas, & J.-R. Gao (Eds.), *Millimeter, Submillimeter, and Far-Infrared Detectors and Instrumentation for Astronomy XI* (Vol. 12181). Article 121900E (Proceedings of SPIE - The International Society for Optical Engineering; Vol. 12190). <https://doi.org/10.1117/12.2629051>

Important note

To cite this publication, please use the final published version (if applicable).
Please check the document version above.

Copyright

Other than for strictly personal use, it is not permitted to download, forward or distribute the text or part of it, without the consent of the author(s) and/or copyright holder(s), unless the work is under an open content license such as Creative Commons.

Takedown policy

Please contact us and provide details if you believe this document breaches copyrights.
We will remove access to the work immediately and investigate your claim.

PROCEEDINGS OF SPIE

[SPIDigitalLibrary.org/conference-proceedings-of-spie](https://spiedigitallibrary.org/conference-proceedings-of-spie)

Gal/Xgal U/LDB Spectroscopic/ Stratospheric THz Observatory: GUSTO

Christopher Walker, Craig Kulesa, Abram Young, William Verts, Jian-Rong Gao, et al.

Christopher Walker, Craig Kulesa, Abram Young, William Verts, Jian-Rong Gao, Qing Hu, Jose Silva, Behnam Mirzaei, Wouter Laauwen, Jeffrey Hesler, Christopher Groppi, Anders Emrich, "Gal/Xgal U/LDB Spectroscopic/Stratospheric THz Observatory: GUSTO," Proc. SPIE 12190, Millimeter, Submillimeter, and Far-Infrared Detectors and Instrumentation for Astronomy XI, 121900E (31 August 2022); doi: 10.1117/12.2629051

SPIE.

Event: SPIE Astronomical Telescopes + Instrumentation, 2022, Montréal, Québec, Canada

Gal/Xgal U/LDB Spectroscopic/ Stratospheric THz Observatory: GUSTO

Christopher Walker^{*a}, Craig Kulesa^a, Abram Young^a, William Verts^a, Jian-Rong Gao^{b,c}, Qing Hu^d,
Jose Silva^b, Behnam Mirzaei^{b,c}, Wouter Laauwen^b, Jefferey Hesler^e, Christopher Groppi^f,
Anders Emrich^g

^aSteward Observatory, 933 N. Cherry Ave, Tucson, AZ 85721;

^bSRON Netherlands Institute for Space research, Landleven 12, 9747 AD Groningen, and Niels
Bohrweg 4, 2333 CA Leiden, the Netherlands

^cOptics Research Group, Department of Imaging Physics, Delft University of Technology, Delft,
2628 CJ, the Netherlands

^dDepartment of Electrical Engineering and Computer Science, Massachusetts Institute of
Technology, Cambridge, Massachusetts 02139, USA

^eVirginia Diodes, Inc., 979 2nd St SE #309, Charlottesville, VA 22902, USA

^fSchool of Earth and Space Exploration, Arizona State University, AZ 85287, Tempe, USA

^gOmnisys Instruments AB, August Barks gata 6B, 421 32 Västra Frölunda, Sweden

ABSTRACT

Gal/Xgal U/LDB Spectroscopic/ Stratospheric THz Observatory (GUSTO) is a NASA Explorers Mission of Opportunity that will make large scale maps of the Milky Way and Large Magellanic Cloud in three important interstellar lines: [CII], [OI], and [NII] at 158, 63, and 205 μm , respectively. During its ~ 75 day stratospheric (~ 36 km) flight, GUSTO's 0.9-meter balloon-borne telescope and THz heterodyne array receivers will provide the spectral and spatial resolution needed to untangle the complexities of the interstellar medium by probing all phases of its Life Cycle. The GUSTO payload consists of (1) a telescope; (2) three 8-pixel heterodyne array receivers; (3) autocorrelator spectrometers; (4) instrument control electronics; and (5) a cryostat. The GUSTO gondola is derived from successful APL designs. Much of the GUSTO instrument architecture and hardware is based on the experience gained in developing and flying the Stratospheric Terahertz Observatory (STO). GUSTO is currently undergoing integration and test and will launch from the NASA Long Duration Balloon (LDB) Facility near McMurdo, Antarctica in December 2023.

Keywords: Terahertz astronomy, Suborbital astronomy, Terahertz telescopes, Terahertz array receivers

1. INTRODUCTION

GUSTO (Fig. 1) will explore the inner workings of our galaxy and the Large Magellanic Cloud (LMC) by probing global star formation properties and the life cycle of interstellar clouds. Of special importance is the formation of molecular clouds from diffuse atomic gas, the feedback from (massive) star formation on the lives of molecular clouds, the impact of shearing motions within spiral arms on cloud evolution, and the impact of these processes on the global structure and evolution of galaxies. The GUSTO mission's science goals are to:

- Witness the formation and destruction of star-forming clouds
- Understand the dynamics and gas flow into and within the Galactic Center
- Understand the interplay among star formation, stellar winds and radiation, and the structure of the interstellar medium (ISM) in the LMC
- Construct Milky Way and LMC templates for comparison to distant galaxies.

From its Ultra-Long-Duration Balloon (ULDB) platform at an altitude of 36 km, GUSTO will survey 124 deg² of the Milky Way and 25 deg² of the LMC at 60" angular resolution using three 8-pixel heterodyne array receivers. The

GUSTO receivers provide km/s velocity resolution and bandwidths sufficiently wide to track all clouds orbiting in the Milky Way and LMC. GUSTO will detect and locate in three dimensions every important interstellar cloud ($A_V > 0.5-1$) in the surveyed regions. The baseline science mission is ~ 75 days. The threshold science mission is ~ 30 days. GUSTO's observing campaign is comprised of three surveys:

- GPS: A Galactic Plane Survey
- LMCS: An LMC Survey
- TDS: Targeted Deep Surveys of selected regions in the Galaxy and LMC

The baseline schedule includes 3.5 days for commissioning activities and 2 hours of scheduled contingency daily.

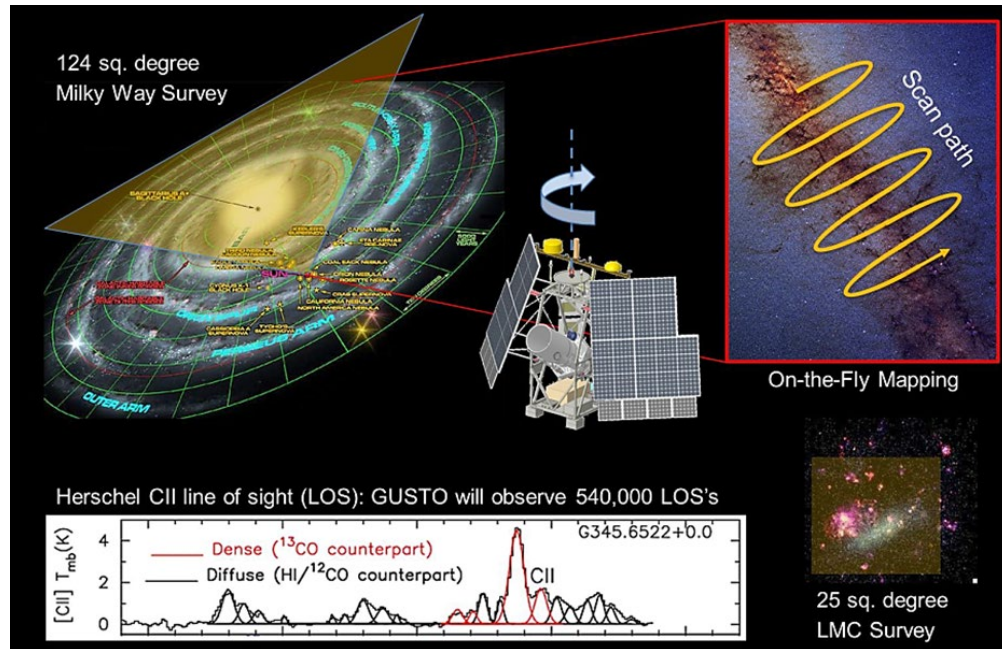

Fig. 1. GUSTO Concept of Operations. When launched from the NASA LDB Facility near McMurdo, Antarctica, GUSTO will fly for ≥ 55 days at an altitude of 120,000 ft. During this time, it will perform fully sampled scans of ~ 124 square degrees of the Galactic Plane and ~ 25 square degrees of the Large Magellanic Cloud. Each line-of-sight observation will yield velocity resolved spectra of [CII], [OI], and [NII]. From these observations 3 dimensional maps of the interstellar medium will be made.

2. SYSTEM DESCRIPTION

The observational goal of GUSTO is to make high spectral (1 km/s) and angular resolution (1 arcmin) maps of the Galactic Plane in [NII] 1.46 THz, [CII] 1.9 THz, and [OI] 4.7 THz. To achieve the angular resolution requirement, the GUSTO telescope is designed to have an aperture of 0.9 m. To achieve the required spectral resolution, GUSTO will utilize heterodyne receivers [1]. GUSTO is a balloon-borne observatory capable of utilizing a LDB zero pressure balloon to provide the baseline mission lifetime of ~ 75 days. The science payload portion of GUSTO consists of (1) a telescope; (2) three 8-pixel heterodyne array receivers, one for each of the target lines; (3) autocorrelator spectrometers; (4) instrument control electronics; and (5) a cryostat. A summary of instrument parameters is provided in Table 1. The GUSTO gondola is derived from successful APL designs. Much of the GUSTO instrument architecture and hardware is based on the experience gained in developing and flying STO-1 and especially developing STO-2. The GUSTO instrument and telescope will be fully integrated and tested at the University of Arizona before delivery to APL for gondola integration. A block diagram of the GUSTO instrument is shown in Fig. 2. GUSTO's optics are designed to provide a 1 arc minute full-width-half-maximum (FWHM) beam size on the sky in all three frequency bands. This is achieved by fully illuminating the 0.9 m, on-axis Cassegrain telescope at the lowest frequency (1.46 THz) and under-illuminating it (slower $f/\#$) at higher frequencies. This facilitates the comparison of intensity among the [CII], [OI], and

[NII] emission lines; simplifies observing mapping modes; and keeps all bands within the proven pointing and tracking capabilities of the gondola. The telescope's optical design closely follows that of STO-1 and STO-2.

Table 1. Instrument Parameters

Feature	Baseline Requirement	Threshold Requirement	Capability
Receiver sensitivity	< 1100 K DSB	< 2200 K DSB	800-1800 K DSB
Number of pixels	8 per band 3 bands	2 per band 3 bands	8 per band 3 bands
Spatial resolution	1.0 arcmin 15" pointing knowledge	1.4 arcmin 23" pointing knowledge	0.65 arcmin [OI] 0.75 arcmin [CII] 0.9 arcmin [NII] 12" pointing
Spectral resolution (channel)	1.3 km/s [CII], [OI] 3.3 km/s [NII]	1.3 km/s [CII], [OI] 3.3 km/s [NII]	1 km/s [CII][OI] 1.8 km/s [NII]
Spectral bandwidth	500 km/s	300 km/s	>550 km/s [CII] [NII] 230 km/s [OI]
Mean data rate	230 kbps	150 kbps	300 kbps
Onboard storage	600 GB	250 GB	960 GB
Mission Lifetime	75 days	30 days	75 days

GUSTO's optical system consists of the telescope, calibration/flip mirror, local oscillator (LO) box, and frequency/polarization diplexers located in the cryostat. When observing sky, the converging beam from the telescope passes through the location of the chopping mirror and then encounters a frequency-selective surface. The surface reflects the high-frequency 4.7 THz beams by 90° to a fold flat and toward the 4.7 THz mixer array, while passing the lower-frequency 1.9- and 1.46-THz beams directly on to their mixer arrays. The sky beam then passes through a 45-degree, 5-10% reflective, dielectric beam splitter. The beam splitter is designed to combine the light from the telescope with that of the respective LO beams. The 1.46 and 1.9 THz beams share a common 13µm thick beam splitter made of Mylar; the 4.7 THz band has a dedicated 2.5µm thick beam splitter. The sky and LO beams then travel together to the mixer arrays after passing through a 2-lens relay consisting of anti-reflection coated silicon lens. Each mixer array consists of 8 pixels in a 2x4 format. All three arrays are thermally strapped to the 4K helium tank.

The 1.46- and 1.9-THz LO beams are produced by frequency-multiplied sources, while the 4.7 THz LO beams are generated by a solid-state quantum cascade laser (QCL). For proper operation, the QCL is cooled to 50-70 K inside the cryostat by a Stirling-cycle cryocooler. A portion of the 4.7 THz LO power is delivered outside the cryostat through a vacuum window for frequency locking, and the remaining power is split into 8 beams using a Fourier grating before being combined with the sky beam on a beam splitter. Both the 1.46- and 1.9-THz LOs operate at room temperature. Each of these LO units directly emit the beams needed for the [NII] and [CII] mixer arrays.

When calibration is needed, the calibration mirror swings into place, directing the light from a COBE/FIRAS-style, low-reflection, blackbody load down to the mixer arrays. The mixers/receivers are calibrated for ~5 seconds on the load at ~30 second intervals. The interval between calibrations is set by the spectroscopic Allan time of the receivers, which is determined through laboratory testing before flight. The calibration load is at ambient temperature.

The hot electron bolometer (HEB) mixer arrays down-convert the high-frequency sky signals to microwave frequencies, multiplying the incident sky and LO beams together across a resistive nonlinearity in the HEB's micrometer-sized niobium nitride bridge. The product of the multiplication contains sum and difference frequencies. Filtering permits only the difference (i.e., intermediate frequency [IF]), signal to appear at the mixer output. From there, stainless steel coax conveys the down-converted sky signal to a series of low-noise cryogenic and room-temperature microwave amplifiers. The amplifiers boost signal levels to the point at which they can be digitized without increasing the noise.

The critical first-stage IF low-noise amplifiers (LNAs) utilize the same high-performance, low-power technology

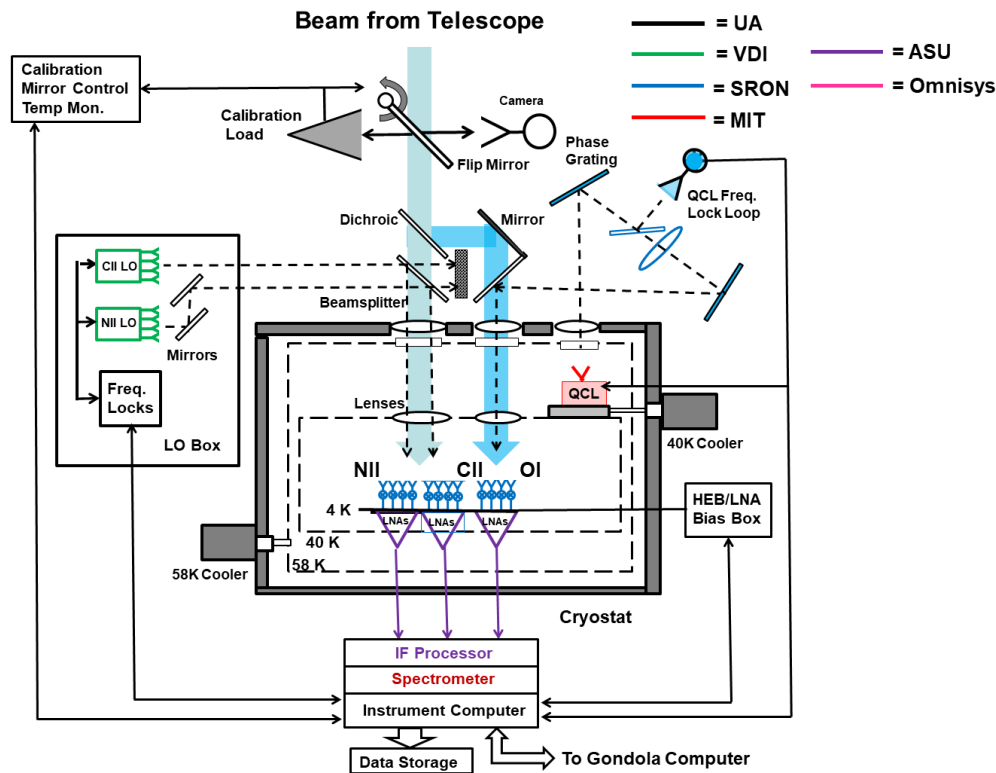

Fig. 2. GUSTO Instrument Block Diagram. The instrument is designed to simultaneously observe at 1.4 THz [NII], 1.9 THz [CII], and 4.7 THz [OI] using 8 pixel arrays in each band.

developed for STO. The IF signals have a center frequency between 1 and 3 GHz and an instantaneous bandwidth of 2.7-3.7 GHz. At our highest observing frequency (4.7 THz: the [OI] line), a 3.7-GHz IF bandwidth will deliver 230 km/s of velocity coverage. Velocity coverage of this order is needed to accommodate the wide velocity dispersion expected in the data toward the inner parts of the Galaxy. Even so, the Galactic Center region will be observed in multiple QCL tunings for [OI]. Each GUSTO pixel has its own autocorrelator spectrometer with software-selected 512, 768 or 1024 channels to produce a power spectrum of the input signal. The power spectra from all 24 pixels are read by the instrument computer and passed on to the gondola via an Ethernet link. The arrays are managed by the Frontend Electronics Module, which contains multiplier and mixer bias cards, instrument housekeeping, and the Instrument Control Computer. The IF outputs from the mixers are processed through a similarly-constructed Backend Electronics Module containing IF amplifiers, IF filters, the correlator spectrometers, the data computer and solid-state disk storage. All boxes (including the LO and Cal/Mirror Box) are shielded against RFI.

3. INSTRUMENT SUBSYSTEMS

3.1 Telescope

The GUSTO telescope, like STO-2, is a traditional Cassegrain system (see Fig. 3). The baseline 90 cm primary mirror is comprised of low-expansion borosilicate glass (with diamond-turned aluminum as backup and a descope option). The mirror blank was coarse-figured to a fast f/1 sphere at Hextek Inc., which is well qualified to manufacture primary mirrors exceeding the quality required for GUSTO. The University of Arizona's Department of Optical Sciences resurfaced and polished the mirror to a parabolic shape, using interferometric metrology to confirm the surface figure, prior to aluminizing the surface. The convex secondary mirror was made from diamond-turned, light-weighted aluminum. The "cradle" (metering structure housing the primary), the secondary support "spider" structure, and the telescope baffle tube are all made of carbon fiber reinforced polymer (CFRP), providing both low weight and high



Fig. 3. GUSTO Telescope. GUSTO employs an $f\#10.4$ Cassegrain telescope with a 0.9m borosilicate mirror and a 14 cm aluminum secondary.

thermal stability. The telescope primary is attached to the mirror cell by way of thin titanium flexures. An Optics Box containing the calibration/flip mirror, calibration load, 1.46/1.9 THz LO diplexing beam splitter, and the 4.7 THz QCL LO frequency lock break-out are located along the telescope axis under the cradle. The cradle is connected to the cryostat with adjustable CFRP struts which provide a flexible but rigid hexapod-like alignment capability. To ensure that the telescope and support structure will maintain better than 10 arcsec optical alignment relative to the star cameras during observations, Finite Element Analysis (FEA) and thermal analysis were performed. There are two main distortions where measurements and analysis are needed to quantify environmental effects on optical quality and pointing knowledge and stability: 1) gravitational distortion and 2) thermal distortion.

Gravitational distortion, or flexure, causes bending modes in the telescope structure with increasing zenith angle. Owing to the rigid CFRP structure, the absolute magnitude of flexure is relatively small, about 15" near horizon and mostly in the cryostat mount. As with all telescopes that bend (i.e., all of them) this flexure term is expected to be highly stable with elevation, has been analyzed by FEA analysis, and will be empirically measured during instrument and telescope integration in Arizona. The flexure-corrected pointing model will be assessed in flight with regular observations to continuously validate the flexure terms. It is estimated that the uncertainty in measured flexure in flight will be about 1/15th beam or about 4". This represents the gravitational distortion error term in the pointing error budget.

Thermal distortion of the telescope has been modeled using the integrated instrument CAD model in C&R Thermal Desktop. The driving concerns with the substantial temperature swings expected between Galactic Plane observations and the Large Magellanic Cloud (LMC), and especially between potential day-night cycles late in the mission, are 1) changes in focus, 2) changes in pointing, and 3) higher level distortions that reduce optical coupling of the primary Gaussian beam. To minimize these effects, the telescope has a baffle made from thin-walled, aluminum sheeting. The inside is coated with black Aeroglaze Z306 and the outside with white Aeroglaze A276. Aeroglaze is a polyurethane coating with high thermal absorptivity and low outgassing properties. The inner surface of the baffle is exposed to direct sunlight when pointed near the Sun (30 degree minimum Sun avoidance angle). The baffle is thermally-connected to the cradle. This increases the cradle temperature to as high as 50C but reduces gradients across the cradle and across the primary mirror. This limits the pointing errors due to temperature changes to under 10" and usually under 5". The residual optical distortions once pointing tip/tilt are removed are negligibly small. The remaining effect is a focus shift owing to temperature changes in the CFRP struts setting the primary-to-secondary distance. At a 30 degree Sun incidence angle, the peak temperature at the top of the secondary hub is 55C. At night, this can drop to -35C. This worst-case condition represents a change in secondary distance of 90 microns, which is readily corrected by the secondary

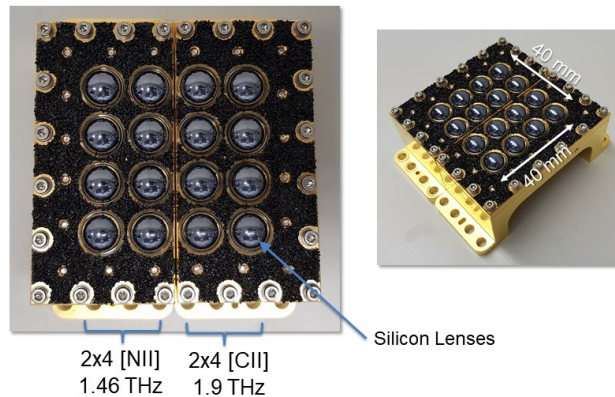

Fig. 4. Focal Plane Arrays. The GUSTO focal plane consists of three 2x4 quasi-optical arrays of HEB mixers developed at SRON/TU Delft.

focus mechanism. A focus-temperature curve will be generated by model analysis and will be automatically used to correct focus in flight. To test the model, focus curves as a function of secondary strut heating (i.e., Sun incident angle) will be performed during instrument commissioning in the first 72 hours of flight. Pointing and focus observations will be routinely performed throughout the entire flight every few hours, but it is expected that after initial validation, thermal monitoring of the secondary structure will be adequate to maintain a high-quality lookup table of focus position vs. strut temperature throughout the flight.

3.2 Mixers

HEB mixers are the only devices that have been shown to provide the sensitivity needed for the proposed GUSTO science investigations [1]. GUSTO will utilize quasi-optical coupled HEB mixer technology originally developed during the Herschel/HIFI development at SRON and the Delft University of Technology. Quasi-optical mixers consisting of a silicon lens and planar (spiral) antenna are a proven technology at “super” terahertz and have been shown to provide the sensitivity needed for GUSTO science investigations. Transitioning these HEB mixers to the 2×4 array for GUSTO was a straightforward repackaging of proven technology (see Fig. 4). Depending on the band, the mixers are designed to provide ~4–5 GHz of IF bandwidth. The IF and DC are contacted through a commercial microwave connector. The DC bias is supplied to each mixer through a bias-tee built into the first-stage LNA. The performance of each mixer of three arrays was verified at SRON. An existing FIR gas laser with emission lines at 1.4, 1.6 and 5.3 THz is used as the LO to characterize those mixers. A THz QCL was also used for testing the mixer performance at 4.7 THz. The verifications included the measurements of the mixer noise temperature, beam pointing, IF bandwidth, and LO power requirement. [2,3]. The 4.7 THz mixers are based on demonstration reported earlier [4]

Each mixer requires ~200 nW of incident LO power on the HEB itself. Predelivery mixer/LO testing was performed with a flight-like optical train to ensure adequate LO power coupling, margin, and adjustability. Prototype 2-beam GUSTO [CII] and [NII] mixer arrays and a single [OI] mixer from SRON were flown on STO-2 in 2016.

3.3 Local Oscillators

The [CII] and [NII] LOs are provided by VDI. The [OI] LO is designed and fabricated by MIT/Sandia. The LOs are housed in the optics box atop the cryostat; the QCL lives in the cryostat itself. All LOs are frequency locked under computer control. Prototype versions of each were flown on STO-1 and STO-2. The 1.4 [NII] and 1.9 [CII] LO chains consist of a synthesizer, followed by an active multiplier, power amplifier stages, and a cascade of GaAs-based planar multiplier Schottky diode circuits. Each HEB mixer as a dedicated LO chain (see Fig. 5) capable of providing ~15 μW per pixel. The 4.7-THz LO for GUSTO is based on a QCL with the same semiconductor quantum-well structure as an IR QCL. Key requirements of the terahertz QCL as LO are as follows: produce a single frequency line that is within a few gigahertz of the [OI] line, have a line width ≤1 MHz, have sufficient output power to quasi-optically pump the mixer array (>1.5 mW), and operate at a temperature of 50-70K.

GUSTO’s 4.7-THz LO uses a third-order distributed feedback (DFB) QCL based on a metal–metal, lateral corrugated

waveguide design [5], which is the most advanced terahertz QCL for the purpose of LOs (see Fig. 6). The QCL devices were designed and fabricated at MIT and are based on an MBE wafer grown at Sandia Labs. The unique features of the

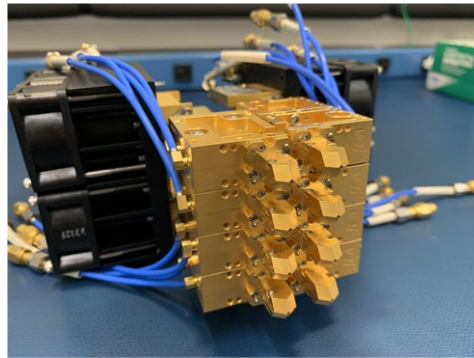

Fig. 5. 1.9 THz [CII] Local Oscillators. GUSTO utilizes 2x4 arrays of active frequency multipliers from VDI Inc. to pump the 1.4 THz [NII] and 1.9 THz [CII] mixer arrays.

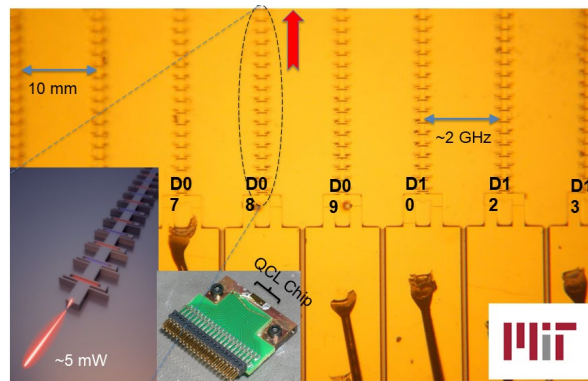

Fig. 6. 4.7 THz [OI] Local Oscillator. GUSTO utilizes a single, high power QCL from MIT, together with a phase grating designed at SRON and manufactured by ASU, for the 4.7THz [OI] LO.

design include tunable, single-mode frequency operation and a well-behaved output beam. The former feature permits frequency locking, and the latter is crucial for efficiently coupling the emergent beam from the QCL to the HEB mixers. The output power of the flight QCL is ~5mW and can be controlled to within 1.5–3 GHz of the [OI] line (4.7448 THz). In flight, we will utilize a QCL frequency lock system successfully developed and tested by SRON/TU Delft [6,7]. A Fourier phase grating is used to generate 8 LO beams from the single, high power QCL beam [8]. The LO power to each pixel is controlled with a proven quasi-optical gain control loop [9,10].

3.4 IF Amplifiers

The IF subsystem consists of 24 low noise amplifiers (LNAs) at 20K and two cascaded amplifiers outside the cryostat in

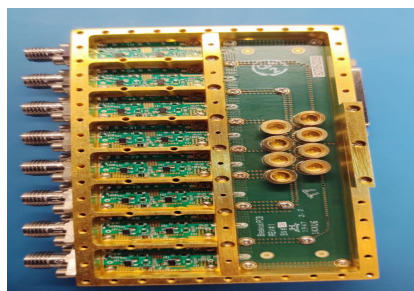

Fig. 7. 1x8 LNA cryogenic module fabricated by ASU.

the Backend electronics module. The LNAs are constructed at ASU using SiGe amplifiers, which are required to meet a noise temperature of $<10\text{K}$ from 0.5 to 6 GHz (see Fig. 7). This team's LNAs have successfully flown on STO. Fixed attenuator pads will be inserted between the two 300K amplifiers stages to bring the system output to -15 dBm , the appropriate input power for the digitizer in the digital autocorrelation spectrometer. Custom microwave ribbon cables are used to connect the LNAs to 24 SMA-type cryostat hermetic connectors.

3.5 Spectrometers

To meet GUSTO's instrument requirements, each of the 24 IF outputs from the HEB mixers and LNAs must be processed efficiently into spectra with per-channel resolving powers ($\lambda/\Delta\lambda$) as high as 3×10^6 . While analog filterbanks, acousto-optical spectrometers, and analog correlators have been used for single element receivers and small (~ 4 beam) arrays, GUSTO's large-format focal plane arrays demand the highly-scalable digital backend spectrometers that are now realizable from the Moore's law expansion of DSP capabilities. Two digital backend spectrometer classes have been fielded: digital autocorrelators and FPGA-based direct-FFT spectrometers. While direct FFT spectrometer capabilities are developing rapidly, the well-characterized Highly Integrated Full-custom Autocorrelation Spectrometer (HIFAS) autocorrelator ASICs from Omnisys Inc. had better power characteristics and a higher TRL at the time of selection, rendering it superior for the GUSTO mission.

The HIFAS chip is the core of the spectrometer backend. It is a full custom ASIC made in an 180nm BiCMOS process with both the sampler and correlator integrated onto the same chip. The ASIC implements a coarse (3-level) ADC on the input before the quantized data is fed to the correlator pipeline and terminate in 40-bit lag counters (where topmost 32-bits are available for readout). Besides the lag counters there are also monitors required to correct the data as a consequence of the coarse quantification. The HIFAS ASIC is a proven design that has been successfully operated at a sampling clock of up to 14 GHz, exceeding GUSTO's most demanding requirements for the Band 3 (4.7 THz) spectrometer. It passes all performance tests including dynamic range, linearity, channel shape, and power consumption. It passes single-event and total dose radiation tests from a Co-60 source at the 30 kRad level.

The high degree of integration in HIFAS allows the construction of nearly identical modules for all three GUSTO focal planes (see Fig. 8). One module is built from two identical correlator units containing four HIFAS ASICs each and a sampling oscillator. The units share the same controlling FPGA and power conditioning. Grouping design modules together forms a complete 8-pixel spectrometer for each of the receiver bands.

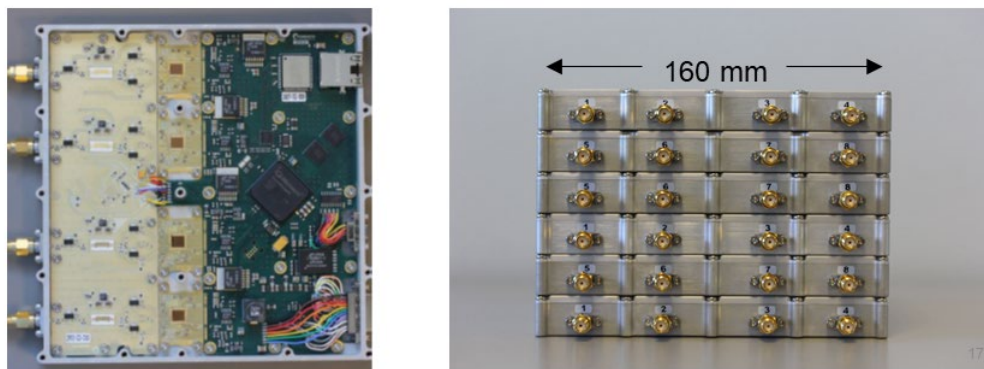

Fig. 8. GUSTO Autocorrelator Module. This compact module can process up to 120GHz of spectra in 24,576 channels. The total DC power draw is 75 W with a mass of 2.5 kg.

Only minor hardware modifications are needed between the modules. The input bandpass filters have been chosen to reflect the input IF for each of the three receiver bands, with minor adjustments in amplification. The sampling clock frequency is different for each of the bands, but is synthesized and injected into the modules in precisely the same way. Table 2 demonstrates the specifications of the three spectrometers as they have been configured for GUSTO. The highly modular design of the GUSTO spectrometers allows for straightforward integration into the science instrument. The instrument's data computer is responsible for all communications with the spectrometer, both for commanding and data product return.

Table 2. Autocorrelator Characteristics

Specification	Band 1 1.5 THz	Band 2 1.9 THz	Band 3 4.7 THz
Bandwidth (GHz)	2.7	3.7	3.7
IF-band (GHz)	0.3-3	0.3-4	0.3-4
Clock (GHz)	9	11	11
Resolution MHz	8.8	5.4	10.7
Sampling	direct	direct	direct
# channels	512	1024	512
Input RF power	-15 dBm		
Power (W)	20	30	25
Size (mm)	160x160x20 each		
Mass (kg)	0.8	0.8	0.8
I/O	Ethernet		

3.6. Cryostat

The GUSTO mixer arrays and LNAs are kept at cryogenic temperatures in a Ball Lightweight Low Cost (LLC) Cryostat (see Fig. 9). This liquid helium cryostat was designed, built, and tested by Ball for NASA missions. The LLC cryostat was modified in partnership with UA for use on STO-1 and STO-2. The GUSTO mission leveraged this heritage. The LLC cryostat was designed for operation in zero gravity with superfluid helium. GUSTO will operate in normal gravity

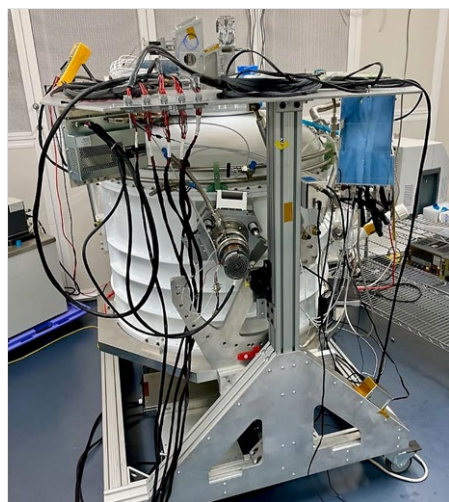

Fig. 9. GUSTO Cryostat. The cryostat utilizes a 150 liter liquid helium tank, together with vapor cooled shields and a Cryotel CT cryocooler to achieve a cryogenic hold time of ~75 days. A separate Cryotel CT cryocooler is used to cool the QCL to ~55K. Both cryocoolers utilize a combination of active and passive vibration damping in order to minimize microphonics to the focal plane and maintain telescope pointing accuracy in flight.

with normal liquid helium; therefore, it does not require a porous plug phase separator or internal, motor-actuated valves. This simplified the GUSTO plumbing and allowed the tank to be increased in size to 150 liters from the STO volume of 95 liters. The GUSTO cryostat is configured to operate from 0° to 90° elevation. This required slight changes in the routing of the helium fill and vent plumbing, which result in a simpler, more robust design. A backpressure valve on the vent line maintains the helium pressure at 15 psia and the liquid helium temperature at 4.2 K.

The GUSTO mixer arrays and associated optics are mounted in an insert, which is then mounted to the top of the helium tank. They dissipate <1 mW and operate at 4.5-6 K. A cryocooler is mounted on the cryostat vacuum shell to provide cooling of the outer vapor-cooled shield (OVCS). The mixer LNAs are mounted to an intermediate temperature stage cooled by the OVCS to 25-30K. As mentioned earlier, a second cooler is used to cool the 4.7 THz QCL LO stage to 50-70 K. The cryocooler chosen for both applications is the Sunpower Cryotel CT, a low-cost, commercial, linear Stirling cycle cooler with an active vibration dampening system. STO-2 used the very same two-cooler model of operation for cooling the OVCS and the QCL. The cryostat demonstrated performance with the cryocooler heat reject temperature and the cryostat outer shell temperature both at 25C is consistent with all mission thermal and hold time requirements. The heat generated and lifted by each cryocooler is transported to a radiator on the rear of the gondola with a pumped fluid loop using a glycol/water mixture. This cooling loop also rejects heat from the instrument LOs and control electronics. A cooling loop of similar design was flown on STO-2 in 2016.

4. SUMMARY

The GUSTO instrument is fully assembled and will undergo tests in a thermal vacuum chamber at NASA's Columbia Scientific Balloon Facility in Palestine, TX in August-September 2022. The instrument will then be integrated to the telescope at the University of Arizona. In March 2023 the telescope/instrument will be integrated with the GUSTO gondola at the Applied Research Laboratory in Columbia, Md. Following observatory level testing, GUSTO will be shipped to Palestine, TX to under Compatibility Testing with the NASA provided telecommunications package (i.e., SIP). From there, GUSTO will be shipped to McMurdo, Antarctica for a December 2023 launch.

REFERENCES

- [1] Walker, Christopher K., "Terahertz Astronomy", CRC Press, Taylor & Francis Group, Boca Raton, London, New York (2016).
- [2] Gaspar Silva, J. R., Finkel, M., Westerveld, M., More, N., Young, A., Kulesa, C., Walker, C., Van Der Tak, F. & Gao, J. R., "High Accuracy Pointing for Quasi-Optical THz Mixer Arrays," *IEEE Transactions on Terahertz Science and Technology*, vol. **12**, 53-62 (2022).
- [3] Gaspar Silva, J. R., Laauwen, W. M., Mirzaei, B., Vercruyssen, N., Finkel, M., Westerveld, N. More, N., Young, A., Kulesa, C., Walker, C., Van Der Tak, F. & Gao, J. R., "4×2 Hot electron bolometer mixer arrays for detection at 1.46, 1.9 and 4.7 THz for GUSTO" (submitted)
- [4] Kloosterman, J.L., Hayton, D.J., Ren, Y., Kao, T.Y., Hovenier, J.N., Gao, J.R., Klapwijk, T.M., Hu, Q., Walker, C.K., Reno, J.L., "Hot electron bolometer heterodyne receiver with a 4.7-THz quantum cascade laser as a local oscillator", *Appl. Phys. Lett.* **102**, 011123 (2013).
- [5] Khalatpour, A., Paulsen, A. K., Addamane, S. J., Deimert, C., Reno, J. L., Wasilewski, Z. R. and Hu, Q., "A Tunable Unidirectional Source for GUSTO's Local Oscillator at 4.74 THz," *IEEE Trans. Terahertz Sci. Technol.*, **12**(2). 144-150 (2021).
- [6] Hayton, D. J., Khudchencko, A., Pavelyev, D. G., Hovenier, J. N., Baryshev, A., Gao, J. R., Kao, T. Y., Hu, Q., Reno, J. L., Vaks, V., Phase locking of a 3.4 THz third-order distributed feedback quantum cascade laser using a room-temperature superlattice harmonic mixer, *Appl. Phys. Lett.* **103**, 051115 (2013).
- [7] Khudchenko, A.V., Hayton, D.J., Pavelyev, D.G., Baryshev, A.M., Gao, J.R., Kao, T-Y., Hu, Q., Reno, J.L., Vaks, V.L., "Phase locking a 4.7 THz quantum cascade laser using a super-lattice diode as harmonic mixer," 39th International Conference on Infrared, Millimeter, and Terahertz waves (IRMMW-THz), pp. 1-2 (2014), doi: 10.1109/IRMMW-THz.2014.6956455
- [8] Mirzaei, B., Gan, Y., Finkel, M., Groppi, C., Young, A., Walker, C., Hu, Q. & Gao, J. R., "4.7 THz asymmetric beam multiplexer for GUSTO," *Opt. Express* **29**, 24434-24445 (2021)

- [9] Hayton, D.J., Gao, J.R., Kooi, J.W., Ren, Y., Zhang, W. & de Lange, G., "Stabilized hot electron bolometer heterodyne receiver at 2.5 THz," *Appl. Phys. Lett.* **100**, 081102(2012).
- [10] Ren, Y., Hayton, D.J., Hovenier, J.N., Cui, M., Gao, J.R., Klapwijk, T.M., Shi, S.C., Kao, T.Y., Hu, Q. & Reno, J.L., "Frequency and amplitude stabilized terahertz quantum cascade laser as local oscillator," *Appl. Phys. Lett.*, **101**, 101111 (2012).