

**Review of ballast track tamping
Mechanism, challenges and solutions**

Guo, Yunlong; Markine, Valeri; Jing, Guoqing

DOI

[10.1016/j.conbuildmat.2021.123940](https://doi.org/10.1016/j.conbuildmat.2021.123940)

Publication date

2021

Document Version

Accepted author manuscript

Published in

Construction and Building Materials

Citation (APA)

Guo, Y., Markine, V., & Jing, G. (2021). Review of ballast track tamping: Mechanism, challenges and solutions. *Construction and Building Materials*, 300, 1-22. Article 123940. <https://doi.org/10.1016/j.conbuildmat.2021.123940>

Important note

To cite this publication, please use the final published version (if applicable).
Please check the document version above.

Copyright

Other than for strictly personal use, it is not permitted to download, forward or distribute the text or part of it, without the consent of the author(s) and/or copyright holder(s), unless the work is under an open content license such as Creative Commons.

Takedown policy

Please contact us and provide details if you believe this document breaches copyrights.
We will remove access to the work immediately and investigate your claim.

Review of ballast track tamping: mechanism, challenges and solutions

Yunlong Guo¹, Valeri Markine¹, Guoqing Jing^{2*}

1. Faculty of Civil Engineering and Geosciences, Delft University of Technology, Delft, 2628CN, Netherlands

2. School of Civil Engineering, Beijing Jiaotong University, Beijing, 100044, China

*. Corresponding author

Email addresses: gqjing@bjtu.edu.cn (G. Jing)

Abstract: Railway ballast beds bear cyclic loadings from vehicles and deteriorate due to ballast particle degradation (breakage and abrasion), ballast pockets (subgrade defects), fouling (or contamination) and plastic deformation of the beds. Ballast bed deterioration changes the ballast track geometry, which leads to uncomfortable rides, exacerbates wheel-rail interactions and, most importantly, causes safety issues (e.g., derailment).

To align the track geometry, tamping is the most widely used means of filling ballast-sleeper gaps and homogenizing ballast beds. Although many studies have been performed on tamping, some necessary research gaps still need to be addressed. To stress the research gaps, tamping studies are critically reviewed in this paper, and the tamping mechanisms, challenges and proposed solutions are introduced and discussed. This review aims to 1) help researchers discover important research directions related to tamping, 2) propose means for tamping methodology improvement/development, and 3) provide advice for developing novel railway track maintenance.

Key words: Tamping; Tamping machine; Railway ballast; Maintenance; Ballast bed

1. Introduction

With the rapid development of all types of railways (metro, intercity, high-speed and heavy-haul railways), the challenges to railway track performance are increasing [1, 2]. Ballasted tracks have remained the most widely used compared to slab tracks. They are particularly suitable for special areas due to their easy maintenance, e.g., tracks on bridges (or in tunnels), soft subgrade and use in freezing regions [2, 3].

With the increasing demand for higher train speeds and capacities (passengers and freights), the challenge of maintaining ballast beds has attracted significant attention. This challenge requires increased focus for the following reasons.

- Ballast beds are undergoing more intense shock and vibration (higher speeds and heavier freight), leading to rapid deterioration of the ballast bed [4-6]. It is thus necessary to restore ballast bed performance by maintenance for safety reasons.
- New ballast track designs are being developed (e.g., ballast glue [7, 8], steel slag ballast and ladder sleeper [9, 10]). Therefore, maintenance methods require more developments, such as different maintenance strategies for different track structures and maintenance for tracks in special areas (e.g., soft subgrades).

- Maintenance cycles are decided upon depending on experiences [11, 12], which needs to be improved towards automatic, systematic and accurate maintenance. In particular, applying artificial intelligence (e.g., machine learning, deep learning) for maintenance cycle prediction is the development tendency, such as using data from structural health monitoring [13, 14].

Tamping is the most widely applied means for ballast track maintenance, and it is necessarily performed for newly built railway lines [15]. It is also helpful for improving track stability and ballast bed performance. In addition, it corrects the ballasted track geometry by lifting up and shifting the rail and sleeper. Currently the tamping machine has replaced manual tamping in rapid, highly mechanized and automatic directions.

Studying tamping requires focusing on three parts, i.e., tamping machine improvement, tamping process improvement and tamping result evaluation.

Tamping machine: Tamping machines are machines used for the tamping process with a high efficiency and high quality. Tamping machines are produced by three main companies, i.e., Harsco (USA), Matisa (Switzerland) and Plasser & Theurer (Austria). The tamping unit is the core component of a tamping machine. Technologies for tamping machines have been developed over the last 100 years and have become mature in recent decades because of rapid railway development. The core technologies for tamping machines are controlled by the three companies; thus, the number of published studies is limited.

Tamping process: The basic principle of the tamping process (using tamping machines) is moving the ballast particles through the oscillation (or vibration) and squeezing the tamping tines when lifting the track.

- Due to tamping tine oscillations, the ballast particles are shaken and move to their most stable positions, by which the ballast bed becomes homogeneous.
- Due to the squeezing of the tamping tines, some crib ballast particles are forced to move to the position beneath the sleeper, by which the sleepers have better support from the ballast bed.
- Due to lifting the track, the track geometry irregularity is corrected, including the surface (longitudinal level or vertical alignment), alignment (horizontal alignment), cross level (cant), and warp (twist) [16].

Tamping result: Tamping results are not easy to evaluate in practice. Many methods have been proposed using numerical simulations. The methods for tamping result evaluation are presented as follows.

- Ballast particle breakage and abrasion.
- Coordination number of the ballast bed.
- Bulk density (or porosity) of the ballast bed.
- Bearing stiffness of the ballast bed.
- Lateral and longitudinal resistances of the ballast bed.
- Ballast particle motions (displacement, velocity, and acceleration).
- Contact forces (ballast-ballast and ballast-sleeper).

The paper is structured as follows:

1. Introduction
2. Tamping mechanism and function
 - 2.1 Tamping principle and process

- 2.2 Tamping machine and operation
- 3. Challenges
 - 3.1 Determination of the tamping parameters
 - 3.2 Ballast breakage and abrasion
 - 3.3 Low efficiency and noise
 - 3.4 Lateral resistance reduction
 - 3.5 Hanging sleeper and pressure distribution (without a ballast addition)
- 4. Proposed solutions
 - 4.1 Optimization of tamping parameters
 - 4.2 Condition-based or predictive tamping
 - 4.3 Tamping efficiency improvement and noise control
 - 4.4 Tamping with a compactor for lateral resistance improvement
 - 4.5 Application of proper maintenance methods
- 5. Perspectives and future maintenance trend

2. Tamping mechanism and function

In this section the following four aspects are introduced.

- Limited studies focused on the tamping principle. For example, one theory on the vibrating compaction of ballast beds proposed that transverse waves loosen ballast beds while longitudinal waves compact ballast beds [17].
- The tamping process includes four steps of driving the tamping tines, i.e., penetration, squeezing, closing and pulling out.
- Tamping machines mainly focus on how to drive tamping units (excitation mechanism), such as the vibration frequency of the tamping tine.
- The tamping operation determines when and how to operate ballast bed tamping.

2.1. Tamping principle and process

Concerns for the tamping principle and process are mainly related to the rheology of the ballast bed, which describes the fluidity of the ballast bed during tamping. In other words, due to the resonance of the ballast bed and tamping tines, the ballast bed presents fluid-like conditions [18].

2.1.1. Tamping principle

The physical process of tamping is that ballast particles are forced to move to their equilibrium positions. The physical process of tamping is briefly described as follows.

Due to the loadings from tamping tines, the ballast particles act via exciting forces (from tamping tine vibration), inserting forces (tamping tine penetration) and squeezing forces (tamping tine squeezing). The forces are then transmitted by vibration or physical contacts (ballast-tamping tine). Specifically,

- First the tamping tines are inserted into ballast beds with vibrations. The vibration is a transverse wave that makes the ballast bed loose, for which the tamping tines easily penetrate [19].
- After the tamping tines have penetrated the ballast bed, longitudinal wave vibrations are applied. Ballast particles currently have two kinds of motions [20].
 - Because static friction between particles is changed to kinetic friction, the ballast particles rearrange because small particles move into the voids between large particles.
 - All forces that act on ballast particles cause breakage and abrasion. This breaks the initial equilibrium system of the ballast particles. Then the small ballast particles fill in the voids. Finally, the system of ballast particles reaches a new equilibrium state.

- Finally, with the squeezing forces the ballast particles are moved to the locations under the sleeper. During squeezing particle breakage and abrasion also occur. At the same time, the small particles and crushed particles fill in the voids, compacting the ballast particles under the sleeper.

Through this process the ballast particles are rearranged, making the bulk density of the ballast bed change (more homogeneous), which means that the ballast particles under the sleeper are squeezed to be compacted.

However, the abovementioned descriptions are based on hypotheses that have not been proven. More hypotheses are introduced below [21, 22]. More studies should be performed to confirm these hypotheses.

- *Resonance theory.*

Basic knowledge: Resonance is defined as – at one certain frequency, the object has a larger amplitude vibration than at other frequencies. In general, ballast beds can have several resonant frequencies. Mostly, the frequency in low ranges with respect to the ballast bed medium is focused because the vibration of the low frequency is easy to obtain [23].

Resonance theory means that when the vibration frequency of tamping tines is approximately the same as the natural frequency of the ballast bed, the ballast particles are prone to vibration. This leads to a better rearrangement of the ballast particles; consequently, the ballast bed becomes more homogeneous [24].

Discussion: This theory has been studied by experimental tests and numerical simulations to seek the optimal frequency for ballast beds. However, because the natural frequency of ballast particles (ballast bed) varies due to several factors (e.g., ballast material and water content), this theory has not been fully proven.

- *Friction theory.*

Basic knowledge: Granular materials have a discrete nature, which means that each particle has a different shape and surface roughness. Therefore, the friction forces at different particle contacts are different, causing friction inhomogeneity in the ballast bed. In addition, the ballast particles have interlocks similar to cohesion forces (e.g., hardened ballast beds caused by clay fouling), which are related to the gradation, moisture, and layer thickness. The friction forces and the interlocks between particles form the shear strength of the particle assemblies [25].

The forces in ballast assemblies are from friction and interlock forces, which are difficult to break using static forces. Therefore, large inertia forces are required to move the ballast particles [26].

Friction theory assumes that the tamping tine vibration produces large inertia forces and changes static friction to kinetic friction. This theory explains the ballast compaction from the perspective of forces acting on the ballast particles, which is proven by the reduction of compression resistance and shear strength.

Specifically, exciting forces are applied to the ballast particles, inducing the inertia forces. When the inertia forces are large enough to overcome the friction and cohesion forces, the interactions between particles break, which changes the static friction to kinetic friction. The particles move to their lower positions under gravity, leading to ballast bed compaction.

Discussion: However, long-duration vibration causes large and small ballast particles to be separated. The large ballast particles have larger inertia forces, which makes them move down earlier than small ballast particles. These separated layers are not desirable. The tamping purpose is to move small particles into voids, so it is very difficult to perform tamping on the ballast bed (separated layers). Small particles at the upper layer are prone to cause ballast flight phenomena [27].

- *Cyclic loading theory.*

Basic knowledge: Cyclic loading theory describes that one type of material is more easily compacted with cyclic compression forces [21].

In the tamping process, the cyclic compression force is that tamping tines apply several vibrations to the ballast particles. Using this type of cyclic compression force, the ballast bed is compacted.

Discussion: Although low-frequency vibrations can be seen as cyclic compression forces acting on the compacted ballast bed, high-frequency vibration is also a cyclic compression force that cannot compact the ballast bed very well.

- *Alternating shear strain theory.*

Basic knowledge: The alternating shear strain theory is based on mechanical theories. The vibration causes the object to undergo alternating shear forces [28].

The ballast bed compaction results from its shear strain, which is caused by alternating shear forces. The forces rearrange ballast particles.

Discussion: This theory proposes that the forces for the rearrangement of ballast particles are alternating shear forces. However, the evidence has not been sufficient to prove this hypothesis.

2.1.2. Tamping process

As shown in Figure 1, the entire tamping process is divided into four stages.

1. The track is lifted by the clamps to a designated height (e.g., 20 mm).
2. The tamping tines penetrate into the ballast bed with a certain oscillation frequency.
 - Tamping tine oscillation during penetration is used for easy penetration.
 - The oscillation frequency could be different from the frequency when squeezing.
 - The penetration also compacts the ballast bed by pushing the ballast particles apart.
3. The tamping tines squeeze to move crib ballast particles to the locations under sleepers, during which the tamping tines vibrate at certain frequencies.
 - During squeezing movement, the tamping tine oscillation leads to a low friction between ballast particles, and the tamping squeezing force breaks the interlock between the ballast particles.
 - When the ballast bed reaches the desired compaction state, the interaction between the ballast particles and tamping tines also reaches the force-balanced state. In this state, the ballast particles are rearranged and interlocked again (by gravity, particle contact forces and forces from tamping tines) at their final positions.
 - The tamping tines have two types of vibrations (different directions), producing two different waves, i.e., transverse waves and longitudinal waves. The transverse wave is used to reduce friction, while the longitudinal wave is used to shake the ballast particles down for compaction.
 - Some tamping machines also compact the ballast shoulder at the same time.
4. The tamping tines are lifted, and the tamping machine moves to the next sleeper to repeat the tamping process.
 - The tamping tines have free movements when lifting up, by which the compacted ballast particles under the sleeper maintain their positions.
 - This stage causes a void at the earlier tamping tine position, which is usually remedied by a dynamic track stabilizer.

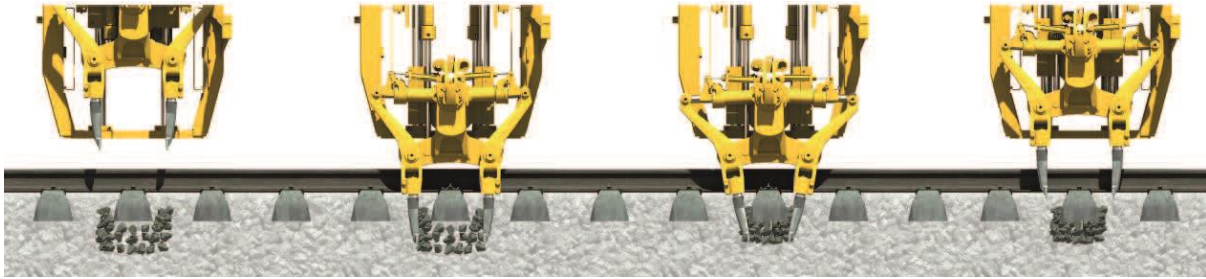

Figure 1 Four stages of the tamping process (figure reproduced from [11])

The tamping process causes several changes in the ballast bed, as shown in Table 1. As introduced in the introduction, the tamping result is relevant to changes in the ballast bed. Tamping has some aims, such as correcting the track geometry and ballast bed homogeneousness. These aims can be reflected by some indicators, which are mostly related to changes in the ballast bed (Table 1).

- *Bulk density.* Bulk density describes the ratio of the overall mass of a ballast assembly to its ballast assembly volume. At the field site, it can be measured by digging a hole (to weigh the removed ballast) and filling it in with water (to measure the hole volume). Details can be found in [2].
- *Lateral resistance.* The lateral resistance describes the resistance of the ballast bed to the sleeper, which is a key factor in evaluating the track stability, especially for continuously welded rail tracks. In the field site, this can be measured by the single sleeper push test. Details can be found in [29].
- *Longitudinal resistance.* The longitudinal resistance describes the resistance of the ballast bed to the sleeper in the longitudinal direction (direction along the rail). It is also measured through a single sleeper push test, but by pushing the sleeper in the longitudinal direction. More explanations can be found in [30].
- *Settlement.* Settlement was used for two situations in earlier studies. One is the sleeper displacement in the vertical direction after the tamping process and before train operation, and the other is the sleeper displacement in the vertical direction after application to cyclic loadings (real or simulated train operation). Both can reflect the compaction of the ballast under the sleeper.
- *Coordinate number.* The coordinate number describes the contact number of each ballast particle. A higher coordinate number means a good compaction of the ballast bed with a higher loading capacity, which is due to the good force transmission and energy dissipation. This can be easily obtained using DEM (discrete element method) numerical simulations, but no methods (related to ballast) were found to obtain this in experimental field tests.
- *Stiffness.* Stiffness describes the ballast bed resistance to the sleeper in the vertical direction. Proper stiffness and resilience provide long-term stable track performance, reflecting the ballast bed compaction condition. It is measured with a plate load test, which obtains the applied force to the sleeper and ballast displacement (i.e., plate displacement on the ballast).
- *Ballast degradation.* Ballast degradation consists of breakage and abrasion. For the experimental or field tests, the breakage is evaluated by the change in the particle size distribution. The evaluation methods for abrasion have not been used in any studies. As for the numerical simulations (mostly using DEM), the breakage evaluation method has been developed, such as in [31]. Abrasion evaluation methods have not been reported in any studies. It is difficult to simulate fines with small particles in the DEM models, which requires huge computational costs (too many particles).

- *Particle movement.* Particle movement describes the ballast displacements during the penetration, squeezing and withdrawal of the tamping process. This reflects the tamping quality, which is due to proper particle movements leading to a good homogeneity of the ballast bed. For the experimental or field tests, no evaluation methods of particle movement have been reported. However, it can be obtained in DEM simulations.

A short discussion about ballast bed changes due to tamping is given from two aspects: numerical simulations and laboratory/field tests.

For the numerical simulations:

- DEM models are the most commonly applied simulation methods for tamping. The model size remains the largest issue due to the enormous computation cost. In reality, the volume of ballast particles that tamping tines disturb is larger than the ballast bed size of the DEM model.
- Ballast bed changes were not very accurately simulated. Penetration and withdrawal of tamping tines are two very fast movements that have not been realistically simulated. Ballast breakage occurs frequently during tamping tine penetrating. Particle breakage helps dissipate the energy of the tamping tine penetration, which is not properly simulated in almost all DEM models. Another main reason is that the model parameters, such as particle damping and contact damping, are not properly chosen, which leads to unrealistic particle movements, especially during the tamping process and squeezing. During squeezing the tamping tines have high-frequency vibration.
- The main advantage of using DEM models to simulate the tamping process is that some phenomena can be reflected on the mesoscopic level, e.g., contact forces of the sleeper-ballast and between ballast particles. In addition, trying different tamping parameters (explained in Section 3.1) is easy in DEM simulations, which means that the parameters can be simulated in wide number ranges.

For the experimental/field tests:

- To date only some basic evaluations have been performed to determine changes in the ballast beds due to tamping, such as resistance (lateral, longitudinal and vertical) to sleepers and ballast degradation. The evaluation methods/tools are still not sufficiently accurate to provide the entire change process of ballast beds due to tamping. For example, the degradation was assessed by fouling or changes in the particle size distribution, which is an overall evaluation for the ballast bed change, not an evaluation from the perspective of every individual ballast particle.
- All the changes in the ballast bed can be obtained through DEM simulations; however, limited changes can be obtained from the experimental/field tests to validate the changes.

Table 1 Ballast bed changes due to tamping

References	Bulk density	Lateral resistance	Longitudinal resistance	Settlement	Coordinate number	Stiffness	Ballast degradation	Particle movement	Others
Tutumluer et al., 2006 [32]		√							
Sysyn et al., 2020; Sysyn et al., 2019 [33, 34]	√								
Sol-Sánchez et al., 2016 [35]				√		√	√		Energy dissipation and pressure under ballast
Paderno, 2011 [36]						√			
Offenbacher et al., 2021 [37]									Squeezing energy; loading stiffness; unloading stiffness
Zhou et al., 2013 [38]				√				√	
Perales et al., 2011 [39]	√			√				√	Total overlap volume between particles
Shi et al., 2021 [31]							√	√	
Martey and Attoh-Okine, 2018 [16]									Surface (longitudinal level), alignment, cross level, gage, and twist
Liu et al., 2020 [2]	√	√	√						Sleeper acceleration
Saussine et al., 2009 [40]	√								
Descantes et al., 2011 [41]							√		Particle size distribution
Saussine et al., 2008 [42]	√				√				Ballast particle contacts to sleeper
Zhou et al., 2012 [43]				√					
Aursudkij, 2007 [20]				√			√		
Barbir [44]									Displacement and force-controlled motion of the tamping tine
Zhou et al., 2013 [45]	√								Water-filling method; particle quantity under sleeper
Zhi-ping et al. [46]		√	√						
Barbir et al., 2018 [47]									Ballast stiffness during compaction
Douglas, 2013 [48]							√		Ballast material and size effects on tamping degradation
Kumara and Hayano, 2013 [49]				√					Sand-fouled ballast bed tamping

2.2. Tamping machine and operation

2.2.1. Tamping machine

With the development of the economy and technology, railway lines have been constructed at full speed, which provides the opportunity for the rapid development of tamping. Three main core technologies have their own features.

Among all the features, the main technology difference is how to drive the tamping unit to achieve the following:

- **High-alignment.** A high-alignment means that the ballast track geometry has a flat surface.
- **High-homogeneity.** A high-homogeneity means that the ballast bed is homogeneous.
- **High-uniformity.** A high-uniformity means that all the tamped ballast beds have almost the same conditions (e.g., porosity and stiffness).

The tamping unit is the core component of the tamping machine. It can be simplified into a tamping tine, center of rotation, friction element, squeezing cylinder and excenter, as shown in Figure 2. This figure shows an example of a tamping unit equipped on a tamping machine, specifically the Dynamic Tamping Express 09-4X E³.

Studies on driving tamping units have become a new and prominent research area in recent years because they determine the development of tamping machines towards automatic and smart tamping [50-55]. Additionally, they determine the tamping efficiency and effectiveness for railway line maintenance.

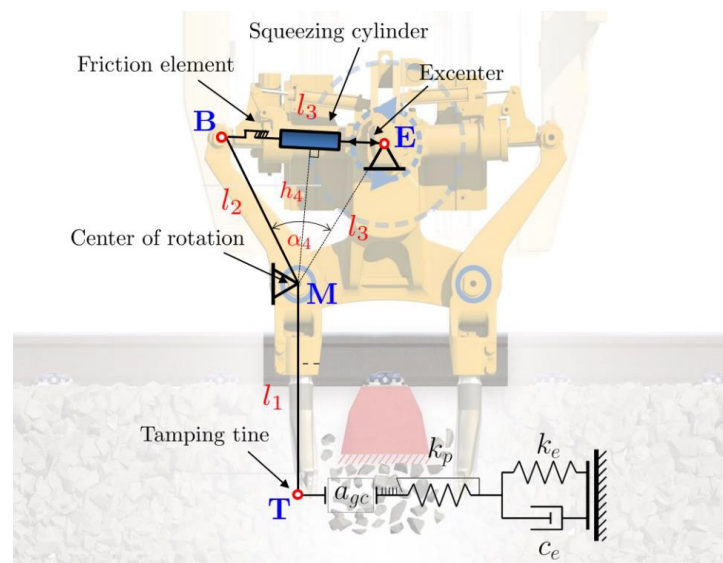

Figure 2 Simplified model of the tamping unit (figure reproduced from [44])

The tamping unit is shown in Figure 3, which is driven by 35 Hz frequency linear movement created by the eccentric shaft in the vertical plane [56]. The hydraulic nonsynchronous tamping principle means

- the tamping tines squeeze the ballast at the same pressure,
- the tamping tines perform directional and linear vibration,
- and the tamping tines move at different paths.

Finally, a uniformly compacted ballast bed is produced.

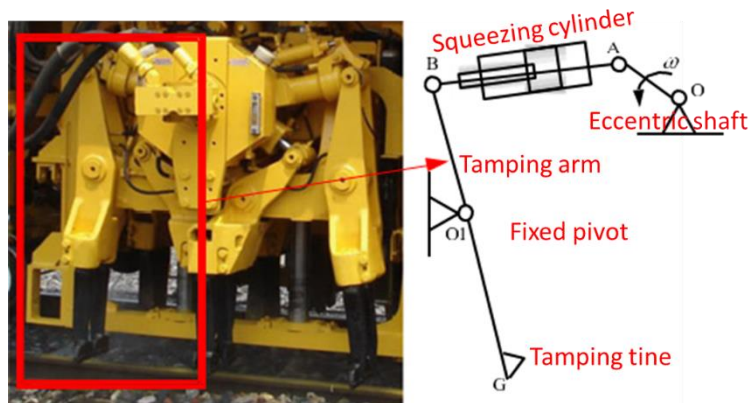

Figure 3 Tamping unit produced by Plasser & Theurer (reproduced from [54])

Figure 4 shows the tamping unit produced by the Matisa company, which is driven by 42 Hz frequency elliptical movement created by the eccentric shaft in the vertical plane. The nonsynchronous tamping principle is applied for the tamping tine with the path of elliptical movement. The elliptical movement vibrates the ballast particles to move in both the horizontal and vertical directions, which

- fills in the gaps between the ballast bed and sleepers and
- compacts the ballast particles by shaking them down.

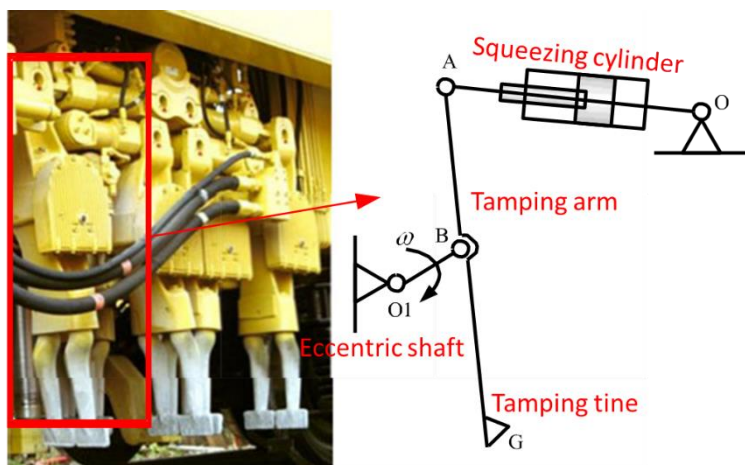

Figure 4 Tamping unit produced by Matisa (reproduced from [54])

Figure 5 shows the tamping unit produced by the Harsco company, which is driven by 53 Hz frequency torsional movement in the horizontal plane. The synchronous tamping principle is applied for tamping tine movements. The advantages of the tamping unit are

- two eccentric shafts drive two tamping arms,
- the ballast bed forces acting on the tamping unit are balanced,
- and tamping unit movements are driven by mechanical components, guaranteeing precise tamping tine displacements.

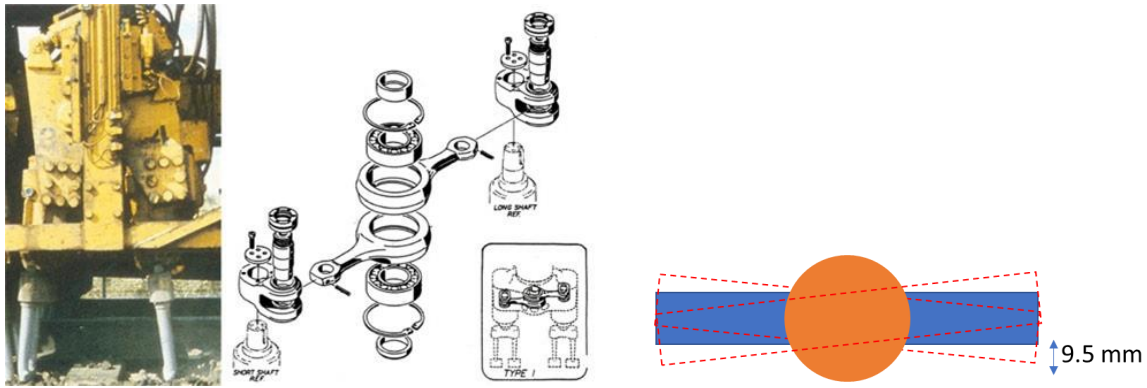

Figure 5 Tamping unit produced by Harsco (reproduced from [54])

The main differences between these three tamping units are the movements and vibration frequency of the tamping tines, as compared in Table 2.

Table 2 Comparison of the tamping units

Tamping unit	Tamping tine movements	Vibration frequency	Advantage	Disadvantage
Plasser & Theurer	Squeezing movement	35 Hz	Good treatment to a hanging sleeper (good compaction); Low energy consumption; low noises	High ballast degradation; high cost (tamping tine)
Matisa	Elliptical movement	42 Hz	Good nestling and homogeneous compaction	Slow tamping speed
Harsco	Torsional movement	53 Hz	High tamping quality and accuracy; long tine service	Slow tamping speed

2.2.2. Tamping operation

The tamping operation is performed when one of two cases occur:

- Irregular track geometry appears at some spot (e.g., isolated joint, turnouts);
- The overall standard deviation of the 200 m track section exceeds the limitations.

Note that tamping is performed differently in different countries. The above two tamping cases are just examples, which are normally the general procedure in most countries. However, the final tamping cases are dependent on the maintenance policy implemented by the infrastructure manager.

The overall standard deviation of track sections is usually chosen as the longitudinal level, as shown in Figure 6.

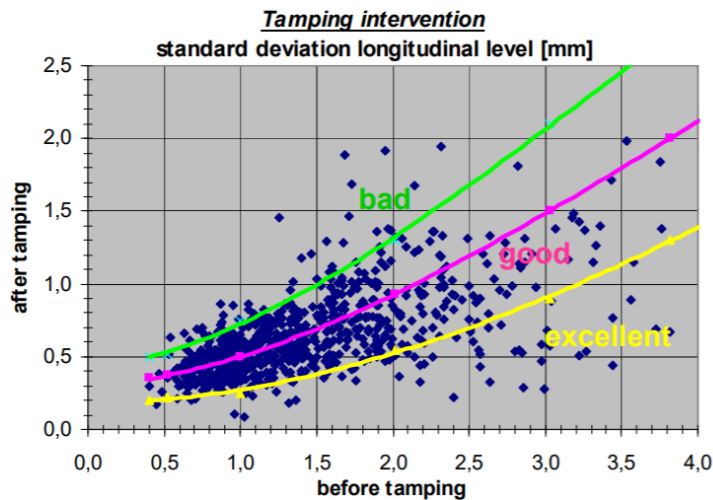

Figure 6 Standard deviation of the longitudinal level before and after tamping (reproduced from [57])

Worldwide, tamping operations are usually performed every 2-6 years and are dependent on many factors, such as structure, traffic volume, geographic position (desert, mountainous) and type of transportation (freight, passenger or mixed traffic) [11].

In most standards, two types of tamping operations are performed: preventive tamping and reactive tamping. The two tamping operations are distinguished as follows:

- Preventive tamping is performed when building a new railway line or correcting track geometry irregularities (after several years of service) in a long section. It helps to maintain the ballast track within an approximate situation (longitudinal, vertical, and lateral directions) to avoid sudden changes in the railway lines.
- Reactive tamping is performed for single track defects (usually within 10 m) instead of a long section. A single defect of the track geometry occurs suddenly in most cases and has very rapid further degradation, which requires instant tamping to repair.

The intervention level (ILE) is a parameter of tamping planning; if exceeded, a tamping operation should be performed. To a large extent this influences the tamping interval (the period between two tamping operations) and the ballast bed lifespan. However, the methods for the ILE calculation are very simple in most standards. The ILE influence on the next tamping operation is not related, only using a constant ILE value.

With the development of maintenance experiences and field monitoring technology, more theoretical studies have been performed on tamping operations, especially for track quality prediction and tamping effectiveness evaluation. Based on these results, a reasonable tamping operation cycle can be decided [12, 16, 58-60].

3. Challenges

3.1. Determination of the tamping parameters

The tamping parameters are mostly inherent. The parameters have been less studied or used differently over the past 70 years. Even though the same parameters are widely used throughout the world, they are not scientific according to the ballast material in nature, as well as the enormous differences in ballasted tracks, such as newly built and broadly graded tracks.

The tamping parameters are the factors influencing the tamping process; in other words, the parameters are the sets of the tamping unit or how the tamping unit is driven. To be more specific, the tamping factors include:

- *The vibration frequency of the tamping tine* is the oscillating frequency when closing the tamping tines, which is used to compact the ballast bed.
- *The vibration amplitude of the tamping tine* is the amplitude when closing the tamping tines, which is used to compact the ballast bed. Note that some studies describe the amplitude using the tamping tine vibration displacement, while some use the vibration angle.
- *The squeezing force* is the maximum lateral force (in the horizontal direction) applied to ballast particles during squeezing.
- *The squeezing angle* is the rotation angle of the tamping tine during squeezing.
- *Tamping tine motion* is the overall motion of the tamping tine, which can be found in Section 2.2.1.
- *Squeezing duration* is the overall time of squeezing.
- *The lifting height* is the track-lifted height before penetrating the tamping tine.
- *Penetration depth* is the tamping tine depth when penetrating into the ballast bed.
- *The penetration speed* is the speed of the tamping tine penetration into the ballast bed.
- *The tamping tine lifting speed* is the speed of pulling out the tamping tines.
- *Squeeze times* are the times of squeezing the ballast particles by tamping tines.

In Table 3 the applied tamping factors in earlier studies are summarized. Additionally, the applied method is given, i.e., experimental tests, field measurements, numerical simulations or method combinations. DEM is short for the discrete element method, which means that the study applied DEM simulations to study tamping.

By comparing the studies in Table 3, it can be seen that vibration frequency is a parameter that has drawn the most focus. In addition, many parameters have not been studied in field/laboratory tests, such as the vibration amplitude, squeezing angle, squeezing force, and tamping tine motion.

In addition, the tamping parameters for tamping units that squeeze are mostly studied in current references, which means not enough studies have been performed for the parameters of other tamping units (without squeeze).

Some specific discussions after comparing the parameters in Table 3 are given as follows.

- The tamping frequency is the most frequently studied parameter with DEM simulations. However, the optimal frequency is not confirmed because it is very difficult to consider all the factors influencing the tamping results, such as the ballast materials and the hardening of the ballast bed (due to fouling). The tamping frequency has been decided by the producers of the tamping machine, which means that in laboratory/field tests, the tamping frequency is rarely studied. There is still a very interesting research gap; for example, DEM simulations can be used to study the optimal frequencies of different tamping units with different tamping tine motion paths (squeezing, elliptical and torsional movements).
- The vibration amplitudes were only studied by DEM simulations in earlier studies. The applied amplitudes of the tamping tines are presented in degrees or millimeters. Most DEM studies confirming the optimal amplitude have not been verified. Confirming the optimal amplitude also makes it difficult to involve all the necessary factors. Additionally, in reality it is not easy to apply the designated amplitudes.
- The squeezing duration is an important parameter for compacting ballast particles under sleepers. While a longer squeezing duration causes greater ballast degradation, a shorter

duration cannot compact the ballast particles. Limited studies have been performed to confirm the optimal squeezing duration. In addition, for the other tamping units (elliptical and torsional movements), the duration is also an unsolved question.

- The lifting height, penetration depth and squeeze times are usually combined in DEM simulations because they are closely related to one another; furthermore, they determine the final track geometry after tamping. The lifting height and penetration depth were studied using DEM simulations or laboratory tests because they are easy to control in reality. However, most of the field/laboratory tests did not consider the squeeze times (which are not mentioned in these studies), which is a research gap.
- The penetration speed influences the ballast degradation of the penetration process, the compaction/homogeneousness of the ballast bed, and the tamping efficiency. Until now, the penetration speeds from the literature have been 0.5, 1.0, 1.5 and 2.0 m/s (DEM simulations). Only one study [41] reported three penetration speeds (slow, normal and fast) without stating the values. It seems that studies on penetration speeds are limited, which means they are, to the best of our knowledge, only decided by experience (without enough theoretical support).

Table 3 Tamping parameters in earlier studies using DEM

References	Vibration frequency (Hz)	Vibration amplitude	Squeezing duration (s)	Lifting height (mm)	Penetration depth (mm)	Penetration speed (m/s)	Squeeze times	Method	Highlight
Tutumluer et al., 2006 [32]	35							DEM	Particle shape effects
Zhou et al. [38, 43, 61-64]	15, 25, 35, 45, 55	0.15, 0.35, 0.55, 0.75, 0.95							
Saussine et al [39, 42, 65]	5, 10, 20, 30, 40, 50		0-1.6		10-20	1.0, 1.5, 2.0		DEM	
Shi et al., 2020 [66]	30-35	0.5°-3°	1.2	10-40	20-30		2-3	DEM	
Wang et al. [67-69]	25-55	7 mm-9 mm			90-95	0.5 -1.5		DEM	
Zhou et al., 2012 [43]		1.8, 4.2, 6.5, 8.9, 11.3 mm						DEM	

References	Vibration frequency (Hz)	Squeezing duration (s)	Lifting height (mm)	Penetration depth (mm)	Penetration speed (m/s)	Squeeze times	Method	Highlight
Paderno, 2011 [36]	35-45		15, 25	20, 60			Laboratory test	Stiff and soft subgrade
Offenbacher et al., 2021 [37]	35					1, 2	Field measurement	Multiple sensors on the tamping unit; sleeper types; squeezing velocity
Descantes et al., 2011 [41]					Three speeds		Field measurement	Tamping times
Aursudkij, 2007 [20]	35		20	20			Experimental test	Full-scale laboratory track model
Barbir [44]		0.8-1.2					Numerical simulation (MATLAB)	Fresh and fouling ballast
Liu et al., 2020 [2]							FEM, field measurement	Tamping times

In most cases, the tamping parameters are chosen according to practice experiences and field experiments [2, 41]. In addition, the parameters to choose from are very limited. For example, each study (experimental tests) usually uses only one set of parameters or only changes one or two parameters. Although numerical simulations have been performed in recent years, the results have not been confirmed in practice.

In real tamping, the different parameters influence the tamping result together. The tamping parameters are related to and influence one another. Studies are not sufficient on how the tamping parameters are related to the tamping results, such as the ballast bed deformation, ballast breakage, lateral and longitudinal resistance, ballast bed porosity and coordination number.

Another issue is that the initial ballast bed condition and tamping parameters are changed in a high-speed railway line compared to a normal railway line. In addition, some existing railway lines are reconstructed for higher train speeds. Obtaining the optimal tamping parameters for these conditions is necessary.

In current DEM simulations of tamping, the following developments for further studies can be found. These points are also considered to be research gaps.

- The ballast bed is the same but with different tamping parameters, and the optimal parameters are determined. However, the optimal parameters are only suitable for this ballast bed.
- DEM tamping models are small models, which means that only part of the track is simulated. For example, in [40] a half-sleeper track model was built including sleeper and ballast particles without a rail or fasteners. This will cause two aspects of possible errors. One is boundary conditions, which means ballast particle motions are not correct. The other is that the system behavior cannot be predicted without the influences of the rail and adjacent sleepers.
- In practice, only irregular tracks or broken tracks need tamping, but all the DEM models of tamping are normal track models. For example, no fouled ballasted track models were found in earlier studies.
- Earlier DEM tamping models simulate only one tamping process, which is not sufficient for many conditions. For example, it does not consider the ballast bed condition after tamping under train cyclic loading to check the real field conditions, such as ballast memory.
- All the DEM tamping models focused on the particle level, such as particle motions and coordinate number, which ignores comparing the mechanical performance (e.g., longitudinal resistance and stiffness) with the field or experimental tests.

3.2. Ballast breakage and abrasion

Earlier field or experimental studies on tamping found that tamping significantly breaks the ballast particles, which occupy 20% of all crushed ballast particles, as shown in Figure 7. In addition, 61% of all fines are produced by tamping twice a year [70]. Most importantly, it has been proven that nearly 53% ballast fouling is contributed to by tamping [71].



Figure 7 Ballast breakage due to tamping (figure reproduced from [18])

The detailed portion of ballast degradation at different particle sizes caused by tamping is different according to British railways. For example, the 38-51 mm particles were reduced by 15-45%. In addition, 13 mm particles increased by 1-5% after 20 penetrations by the tamping tines. Another study proves that 2-4 kg small particles (under 14 mm) are produced during each tamping. For the ballast material, granite, or limestone ballast, 20 tamping times lead to a 6-10% increase in fines. Another study shows that the fines (under 14 mm) are 0.05 kg and 0.25 kg for the two types of granites (one tamping process) [20].

From the above discussion, it can be seen that tamping is harmful to single ballast particles. Earlier studies on tamping effects on the ballast particle breakage also have the following research gaps.

- Single ballast particle breakage is not presented in earlier experimental or field tests. It was only studied in the DEM tamping models, which means that the breakage mechanism during tamping has not been validated. More specifically, many studies have used the single particle crush test [31, 66] or the Los Angeles abrasion (LAA) test [72, 73]. to present ballast breakage or abrasion types in the tamping process, which is not real breakage during tamping. The deformation caused by squeezing of the tamping tine was modeled as a triaxial test in [19] to simulate real field squeezing conditions.
- Until now, ballast breakage during tamping has not been clearly quantified by particle size distribution changes or the percentage of particles below 14 mm. These two methods can only partially show ballast breakage, but presenting the single particle breakage type, mechanism, and influence on the ballast bed performance after tamping is not adequate.
- The ballast properties are tested by LAA tests, impact loading tests, etc. In most cases, the resistance of different ballast properties to tamping has still been unknown until now. For example, the influence of particle size distribution (PSD), ballast shape and ballast strength on ballast breakage during tamping has not been sufficiently studied. The PSD of ballast particles has a great influence due to its effects on the bulk density and contacts between the tamping tines and ballast particles.

Some early studies on tamping-induced degradation are summarized below, as shown in Figure 8.

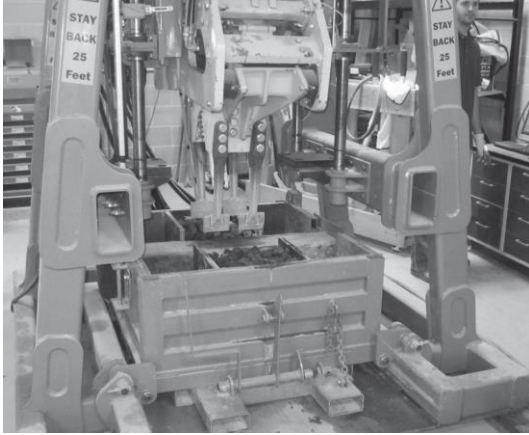

a. Laboratory tests of tamping (small ballast box); figure reproduced from [48]



b. Field tests of tamping (ballast bag); figure reproduced from [41]

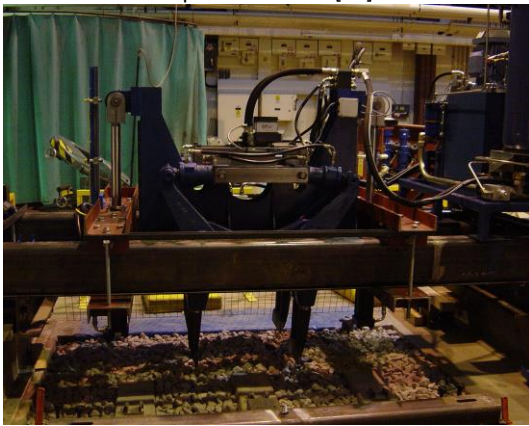

c. Laboratory tests of tamping (track model); figure reproduced from [20]

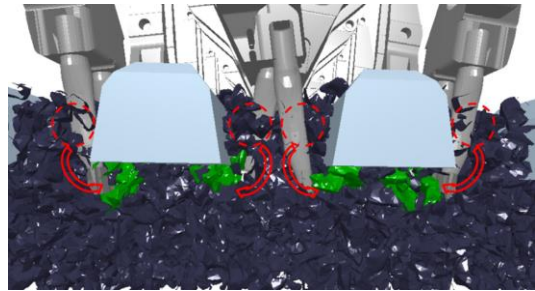

d. DEM simulation of tamping (3D single sleeper model); figure reproduced from [31]

Figure 8 Experimental or field studies on tamping-caused degradation

Figure 8a presents a ballast box with a sleeper under the tamping process. 13 types of ballast materials were tested. It was determined that there is no correlation (degradation degree) between the tamping and particle shape or LAA test results. This study also stressed that it is very difficult to predict the field performance of tamping based on laboratory results because ballast beds in the field are much more complex with too many factors [48].

Figure 8b shows a field test of the experimental line under the tamping process. The ballast particles were placed in a bag, which can confirm the ballast degradation of certain ballast particles. The particle size distributions of certain ballast particles (before and after tamping) are compared. This study determined that ballast particles of approximately 50 mm are most prone to breakage because they are the skeleton of the ballast bed, undergoing and dissipating most of the energy from tamping. The tamping process does not wear the ballast particles very much, which means ballast breakage is the main degradation type during tamping [41].

Figure 8c shows a laboratory test of the full-scale track model (name RTF) for studying the tamping process influence on the ballast breakage, settlement and fouling of the ballast bed. Two types of granites and one type of limestone were tested. The results show that breakage mostly occurred when penetrating the tamping tines instead of the squeezing stage. Tamping accelerates the settlement of the ballast bed, rapidly reaching the stable stage of settlement (fully compacted and consolidated). Driving the tamping

unit with hydraulic vibration is better than mechanical vibration because the hydraulic vibration amplitude decreases during penetration and squeezing, which reduces breakage of the ballast particles [20].

Figure 8d presents a DEM model of the tamping process considering different particle size distributions and particle shapes. The degradation of ballast particles (caused by tamping) in different areas is compared. It is concluded that ballast particles at the crib have the most serious degradation with a breakage rate of 1.65%. Elongated and flaky ballast particles are recommended to be lower than 20% due to their easy breakage during tamping. Wide particle size distributions (using large particles) have a higher degradation resistance than narrow ones [31].

3.3. Low efficiency and noise

3.3.1. Low efficiency

Tamping is a low-efficiency maintenance solution; for example, 16 tamping tools and a twin roller clamp ensure an unequalled compaction quality and an output of approximately 600 meters per hour, depending on worksite conditions and machine settings. Even for a MATISA-B-45 D machine equipped with a double roller plain line clamp and 32 tamping tools fitted with high-frequency elliptical tamping technology, its maximum output is approximately 1,200 meters per hour [74].

The maximum tamping speed is currently 2600 m/h, which is the 09-4X tamping machine (four sleepers per time) combined with dynamic track stabilization [75]. This is relatively slow and has a low efficiency for maintenance in high-speed railways.

Another reason for the low efficiency is that for some special structures tamping is not performed together with normal tamping operations, for example, turnouts and transition zones, as well as the tamping operation for some new track elements, for example, ladder sleeper, Neoballast, winged shape sleeper, nailed sleeper, steel sleeper and polyurethane [8, 9, 29, 76].

The tamping machine for the switch and crossing is normally equipped with 16 tamping tines. Tamping for switch and crossing is low efficiency because it only tamps one sleeper every time. The tamping unit should move horizontally to cover the ballast bed of the turnouts. The switch and crossing usually require tamping several times.

Another factor influencing the efficiency is the operator (driver) of the tamping machine. An experienced operator tamps 1.2-1.5 km/h. In addition, in some special areas (sharp-radius curves), re-tamping is normal, which also requires considerable time.

Studies on driving tamping units have become a new and prominent research area in recent years because they determine the tamping efficiency and effectiveness for railway line maintenance [50-55]. Additionally, they determine the development of tamping machines towards automatic and smart tamping.

3.3.2. Noise

The tamping machine applies hydraulic or mechanical vibration to squeeze ballast particles. During squeezing and penetrating, the tamping machine is very loud, but does not require a limited noise grade in any standards or specifications. However, this needs to be stressed because the tamping operation is performed in the open field and usually during the open hours (midnight). Some railway lines are quite close to living areas.

Current tamping machines have not been equipped with any facilities for reducing tamping noise or applying any insulation facilities. This is harmful not only to the people in living areas, but also to the person driving the tamping machine.

3.4. Lateral resistance reduction

Tamping operations significantly reduce the lateral and longitudinal resistance of ballast beds to sleepers, which causes ride safety and comfort issues [2, 32]. This is because the ballast bed becomes loose and homogeneous after tamping. In particular, pulling out tamping tines from ballast beds causes holes at the crib ballast, which is also a reason for lateral resistance reduction [18]. Tamping delays opening the track, which means that after tamping, the track still requires treatment to restore the ballast bed resistances (e.g., dynamic track stabilization).

Moreover, after tamping the running speed for the maintained railway line is restricted for safety considerations. The speed restriction rules are dependent on whether the track geometry inspection is immediately performed on a Chinese railway after tamping.

- No inspection. After tamping (2 times) and dynamic stabilization (1 time), the speed restriction of the first train is 35 km/h, 45 km/h for the second train and 60 km/h for the third train and trains that follow on the same day. On the second day after tamping, the first train speed is no more than 60 km/h and 80 km/h for all the remaining trains. On the third day after tamping, the first train speed is no more than 80 km/h, and 120 km/h for all the remaining trains. The speed of trains can return to normal hereafter on the fourth day [77].
- With inspection. If the operation speed is over 120 km/h, the train is restricted to a maximum of 120 km/h. If the operation speed is lower than 120 km/h, the trains can run as usual.

In practice, after tamping the ballast bed resistance cannot be fully reflected. In the field the tamping effectiveness is evaluated by longitudinal and lateral resistances. However, due to the limitations of test requirements, test costs and test technologies, the results are usually insufficient.

The studies on the resistance of ballast beds to sleepers after tamping are summarized as follows (Figure 9).



a. Figure reproduced from [2]



b. Figure reproduced from [46]

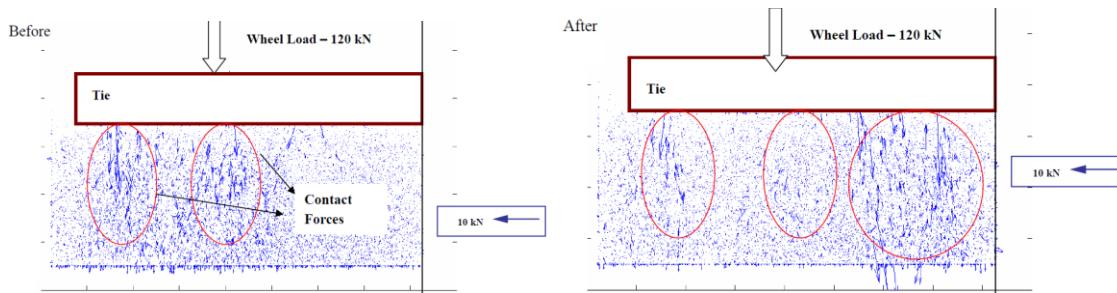
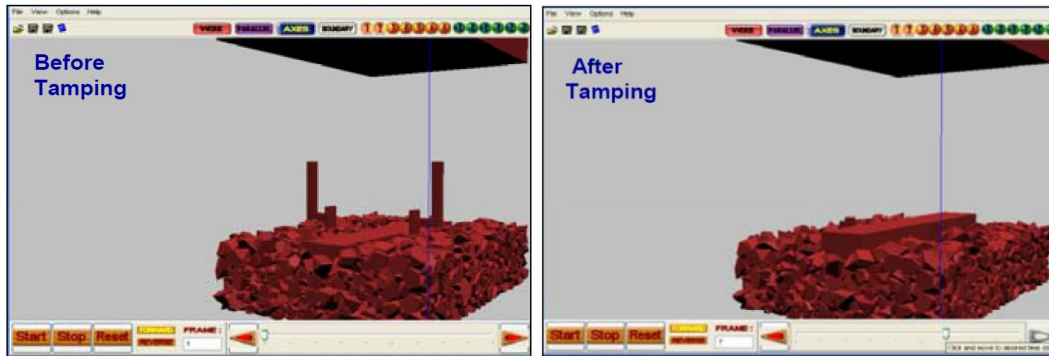

c. Figure reproduced from [32]

Figure 9 Studies on the resistances of ballast beds after tamping

Figure 9a shows the study on the longitudinal and lateral resistance of ballast beds under different tamping times (1, 2 and 3). The sleeper acceleration and vibration transmission are used for the ballast bed compaction evaluation. In addition, an FEM model was built according to the tested railway line configurations. The results show that the longitudinal resistance was reduced by 3.01%, 12.84% and 17.39% for tamping times of 1, 2 and 3, respectively. The lateral resistance was also reduced by 4.34%, 16.19% and 20.34% for tamping times of 1, 2 and 3, respectively. The longitudinal and lateral resistances, damping, and stiffness of the ballast bed are related, which means that tamping using ballast bed damping (with the impact excitation technique) can predict the longitudinal and lateral resistance of the ballast bed. The impact excitation does not disturb the ballast bed, which means there is no need to push the sleeper [2].

Figure 9b shows the field measurement of the longitudinal and lateral resistance of the ballast bed after different tamping times. The results show that when the tamping times were from 3 to 6, the longitudinal and lateral resistance increased with the tamping times. However, after 6 cycles the longitudinal and lateral resistance did not increase any more with an increasing tamping time [46]. This suggests that only using the lateral resistance can evaluate the tamping effectiveness because the longitudinal resistance

has a high linear correlation with the lateral resistance. Note that the total tamping times in this study are 7 times. Considering that the ballast bed has not been homogeneous when tamped 1 to 2 times, the longitudinal and lateral resistances at tamping times from 3 to 7 are used.

Figure 9c presents the DEM model of a half-sleeper track model under the tamping process. The lateral resistance was measured before and after tamping. In the model, the ballast shapes are considered an important factor, which is presented by elongated or flaky shapes, surface textures and angularities. The results show that without considering the ballast breakage, the elongated and flaky particles have little influence on the lateral resistance after tamping. In addition, the lateral resistance was reduced by 40% after tamping [32], which is the same value obtained in [78].

3.5. Hanging sleeper and pressure distribution (without a ballast addition)

The hanging sleeper after tamping is due to the crib ballast particles being squeezed to the sleeper bottom. Afterwards, no ballast particles fill in the holes caused by pulling out the tamping tines. Then the crib ballast particles are reduced and cannot provide sufficient resistance to the sleeper, for which the ballast particles under the sleeper are pushed out to the crib again, causing the hanging sleeper. During tamping ballast addition was not performed. Adding ballast particles is performed in most cases before or after tamping.

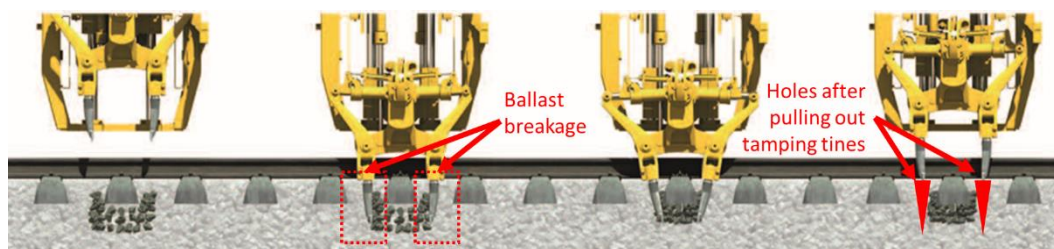

Figure 10 Reasons for a hanging sleeper (figure modified after [11])

The pressure distribution under the sleeper is not uniform because the tamping tines only squeeze at certain locations, not all positions at the crib ballast. This causes the ballast under the sleeper to not provide sufficient resistance in the vertical direction (stiffness). In addition, the ballast particles below the rail undergo the most intensive loads.

Other possible reasons for the hanging sleeper and pressure distribution are given as follows.

Ballast bed hardening. Railway lines at some sections have serious problems of ballast bed hardening due to fouling. The tamping tine penetration depth is approximately 15 mm, and the tamping tine height is 70 mm, which means that ballast particles under 85 mm are not tamped or are influenced very little by tamping. In particular, this part under 85 mm is the hardened area. The difference in the tamping effectiveness also causes hanging sleepers.

Subgrade difference. This consisted of two aspects, i.e., soft subgrade and mud pumping. Tamping on the soft subgrade or mud-pumping ballast bed cannot restore the ballast track geometry but damages the subgrade (especially in rainy weather). This leads to a subgrade low capacity and even failure, which causes hanging sleepers.

Short tamping interval. Tamping machines and other machines for maintenance have become the main methods for ballasted track maintenance. However, the tamping machine mechanism is not clear. To

remain safe, tamping is performed with a very short interval, and in China new railway lines are tamped at least 8 times (even 10 times) before operation. Another example is heavy-haul lines, whose tamping intervals are half a year. These actions significantly damage the ballast bed, which leads to the low bearing capacity of the ballast bed. The low bearing capacity is inhomogeneous, finally causing hanging sleepers.

4. Proposed solutions

4.1. Optimization of tamping parameters

The proposed solution for optimizing the tamping parameters combines DEM simulation and laboratory tests. Note that until now the parameters of the tamping results (squeezing angle, squeezing force, tamping tine motion and tamping tine lifting speed) have remained research gaps and require more exploration (explained in Section 3.1).

The optimization of tamping parameters has been performed in many studies. Some of them applied the DEM models, as shown in Figure 11, while some of them applied laboratory tests or field tests (Figure 12). However, studies using DEMs still require future development towards the direction of more accurate models (full-scale three-sleeper track models) and fast computation.

Specifically, some details are given as follows according to the studies in Figure 11.

- Models are increasingly precise with increasing detail. As shown in Figure 11c, a model of four sleepers with 24 tamping tines was built, which can consider more parameters during the tamping process, such as the boundary condition.
- DEM models that contribute to parameter optimization have the advantage of a lower cost and condition control. Condition control means that the ballast layer condition (e.g., porosity, particle size distribution and particle shapes) can be kept the same in every simulation, for which using the DEM can precisely study how one parameter influences the tamping results.
- Another example is the study using DEM in [31], which used crushable ballast particles. Using crushable ballast particles can determine how tamping influences ballast bed degradation.
- In DEM models, the parameters (e.g., vibration frequency of the tamping tine) can be set to any value; see [39]. The values of the parameters, for example, squeeze times, penetration depth and tamping tine lifting sleeper, can be chosen to check the effects of any certain parameter combinations.

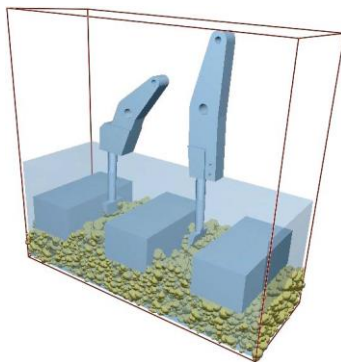

a. Three 1/3 sleepers with 2 tamping tines (figure reproduced from [61])

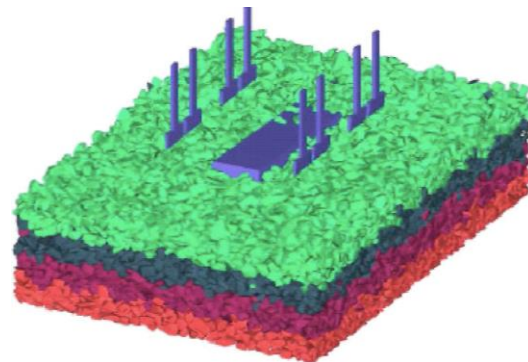

b. One 1/2 sleeper with 8 tamping tines (figure reproduced from [65])

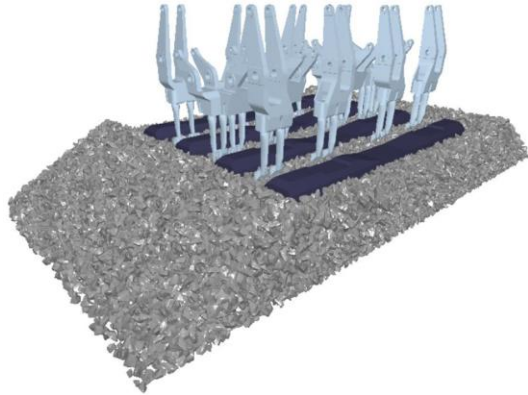

c. Four sleepers with 24 tines (figure reproduced from [66])

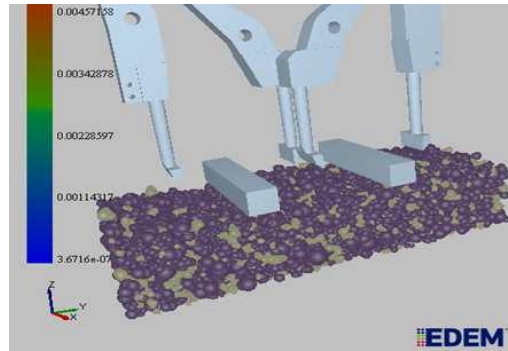

d. Two 1/2 sleepers with 4 tamping tines (figure reproduced from [68])

Figure 11 Examples of discrete element method (DEM) models for tamping

Parameter studies with DEM models require field/laboratory tests for validation. However, reported studies with these tests have some limitations.

- For the tests, more detailed and accurate evaluation methods for ballast degradation should be developed, such as using ground penetration radar (GPR) during the tamping process. GPR is a technique used to process signals, based on which the ballast layer condition can be assessed, such as the ballast fouling and water content [79]. Using GPR can also assess the compaction of the ballast bed, which is very helpful for the tamping result evaluation (accurate and immediate feedback).
- In addition, more sensors can be installed for both the tamping unit (tamping parameters) and the ballast bed (tamping result evaluation). The sensors for ballast beds can be pressure sensors, displacement sensors and accelerometers. The pressure sensor can be used to measure the support from the ballast to the sleeper. The displacement sensor can measure the sleeper settlement after train cyclic loadings (after tamping), and the accelerometer can measure the ballast layer acceleration during tamping. These measured values can be used to assess the tamping results, which are necessary to correlate with the tamping parameters.
- In [34], a method for ballast bed compaction measurement was proposed using the wave transmission speed in the ballast layer. A higher speed means a better ballast bed compaction, which can be used in the tamping result evaluation.
- As shown in Figure 12a, this study aims to use sensors (equipped on a tamping unit) to predict ballast bed stiffness after tamping by the input energy. A similar study was performed in [37], which analyzed a set of recorded data (penetration and squeezing force, oscillation amplitude and squeezing displacement) to monitor ballast conditions, including ballast fouling, ballast humidity, interlayer humidity and clay fouling (from GPR data), as well as short-waved, mid-waved, and long-waved track irregularities (from fractal analyses).
- As shown in Figure 12b, a laboratory test that simulated a full-scale track under real tamping and cyclic loading conditions was performed. The tamping results of different conditions (frequencies, depth, and track lifting) were assessed by measuring and comparing the ballast bed stiffness of the positions under the tamped sleepers. The advantages are 1) the simulated full-scale track, tamping unit and cyclic loading are as close as possible to the field conditions and 2) the ballast bed conditions are easier to control. For laboratory studies, some improvements can be made to

better study the tamping parameters. First, the assessment of the tamping results can include more indicators, e.g., compaction (from GPR) and ballast degradation from the image analysis. Second, the assessment of the tamping results can use some mesoscopic characteristics of the ballast particles, such as ballast displacement and ballast acceleration. Finally, the interaction between the tamping unit and the ballast bed should be considered when studying tamping parameter optimization.

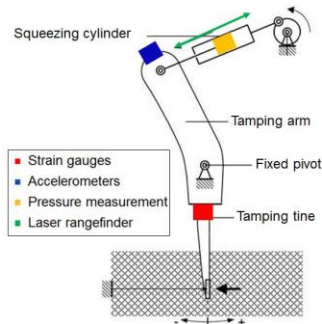

a. Multi-sensor equipped on a tamping unit in a field test (reproduced from [47])



b. Laboratory test (reproduced from [36])

Figure 12 Examples of other research methods for tamping

4.2. Condition-based and predictive tamping

Because tamping breaks ballast particles, condition-based and predictive tamping are needed to reduce unnecessary tamping. Note that at the beginning of using a tamping machine, tamping sometimes causes sleeper breakage and fastener breakage, which is due to the tamping tines going down at the wrong position. This rarely happens because the detection and distance-measuring systems have improved, and the operators (drivers) of the tamping machine have obtained sufficient experience.

Condition-based and predictive tamping are the development trend towards achieving smart maintenance. Currently, many early-stage studies have been performed on smart monitoring, such as structure health monitoring, smart sleepers and smart rock [13, 14]. Increasing numbers of inspection methods have also been developed, such as drones, inspection trains and satellites [80], as shown in Figure 13.

Figure 13a presents the SmartRock, which is made of a 3D printed plastic cover (ballast particle shape) and an accelerometer. The plastic cover has similar rock characteristics, such as density and surface roughness. The accelerometer can also measure the angular acceleration and axial acceleration (three orthogonal directions). This can be used during tamping to show the ballast accelerations and compare the acceleration of the SmartRock with that of ballast particles in the DEM models. In addition, the acceleration of ballast particles can also show ballast bed conditions, such as fouling and stiffness, which can be used as indicators of tamping. This is possible when the acceleration data are well correlated with the ballast bed conditions.

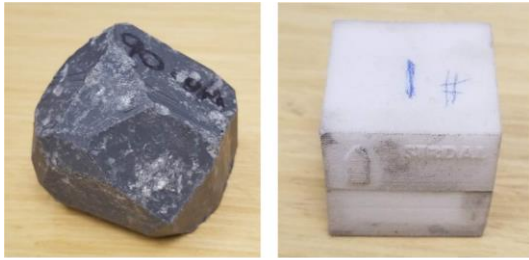

a. SmartRock (reproduced from [14])



b. Drones (reproduced from [81])

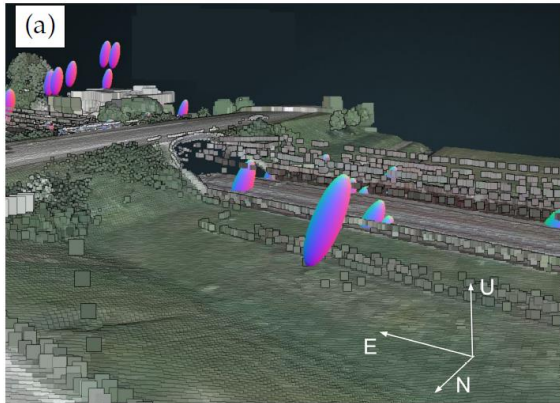

c. Satellite (reproduced from [82])

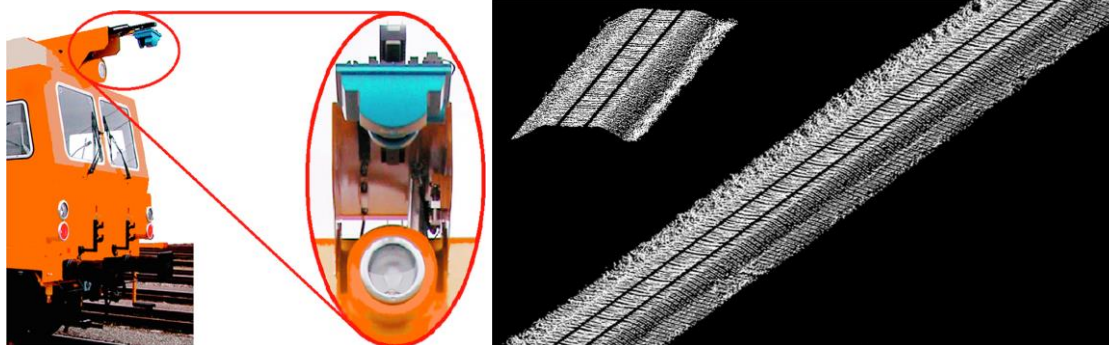
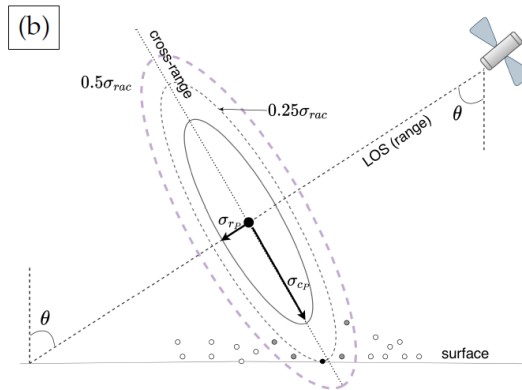

d. Inspection train with a laser scanner (reproduced from [83])

Figure 13 Cutting-edge technique for smart monitoring

Figure 13b shows the drones with a camera to video the track. The track images are analyzed to assess the ballast bed condition and the track geometry. This method has the advantage of fewer interruptions to the train operation and better safety for railway staff. Because inspection trains should be scheduled during the maintenance period (usually early in the morning), drones can operate and take videos at any time. In addition, some measurement of the track geometry is operated by railway workers, which is heavy work and dangerous when trains are passing. Using high-quality (resolution) images can analyze not only the track geometry but also the rail, fastener and, in particular, the ballast particles (particle size distribution, particle roughness, etc.).

Figure 13c shows that using satellite analyses of track geometry, settlement is the main focus. Using satellites can involve many factors that are very important to tamping, such as geology (water, desert, and mountain) and weather (snow, rain). In addition, it can record the track geometry change (revolution) of the entire railway line, which is very helpful to make the tamping plans.

Figure 13d is the inspection train with a camera to video track geometry. It is similar to using the drones. The advantage is that it can measure the track geometry when the track is loaded by the inspection train. A promising idea is to combine the dynamic responses (of the train track) with the rail, sleeper and ballast performances. For example, the ballast bed profile has some defects (e.g., hanging sleeper), which possibly cause some abrupt acceleration change. This defect can also be reflected by the large displacements of the ballast particles (seen through the video). The abrupt change means that this part requires tamping to repair the ballast bed profile (correcting the geometry).

The inspection data of the track have been collected for over one hundred years. Using deep learning and machine learning to analyze the data are still in the early stage and can be developed further for condition-based and predictive tamping. In addition, this method can also be used for track quality prediction.

Some other specific comments are as follows:

- The ground penetration radar is used to accurately obtain the ballast bed conditions, based on which tamping is performed.
- Tamping parameters can change according to the ballast bed conditions. The parameters can also change during the tamping process based on real-time ballast bed conditions, which means that during one squeezing, several vibration frequencies can be used.

4.3. Tamping efficiency improvement and noise control

4.3.1. Tamping efficiency

For the low efficiency of tamping, several methods are determined as follows.

New tamping machine types are proposed. The parameters of the three types of maintenance machines are given in Table 4. The side tamping machine can be seen in [84] (more explanation in Section 4.5). From the table, it can be seen that the side tamping machine is of a slightly higher efficiency than the other two.

Table 4 Tamping machine parameters (reproduced from [84])

Tamping machine	Tine tamping	Stone blowing	Side tamping
Vertical geometry precision (mm)	±1	±3	±2
Maximal operation speed (km/h)	2.0 - 2.4	0.35	3.0
Maximal lifting for one tamping (cm)	5	5	10
Turnouts	Yes	No	No
Fine particles <25 mm (kg/sleeper)	1.6-3.9	>5	0.6
Contact area of tamping unit (m ²)	0.01	-	0.35
Tamping pressure (MPa)	11.5 – 12.5	-	0.135

The current tamping machine is improved for a higher efficiency. The tamping machine has developed in several aspects, for example, from standstill tamping to tamping while moving; from single-sleeper tamping to multi-sleeper tamping; from single-process tamping to multi-process combination (e.g., tamping & stabilizing); and from basic measurement (rail gauge) to optical measurement.

Several sleepers are simultaneously tamped to increase the tamping efficiency. The current highest tamping speed is 2000 m/h. Using the improved tamping machine (four-sleeper time), approximately 2,600 m of track can be tamped per hour [11].

Other maintenance is combined with tamping. Tamping machines in most cases have track-lifting machines, track-lining machines and ballast shoulder compactors, which means multiple maintenance tasks are simultaneously performed.

4.3.2. Automatic and high-accuracy tamping.

The current tamping procedure requires manual operation on the tamping machine. The track quality after tamping significantly relies on the driver's experiences. The heights of track lifting and track lining are controlled by the computer based on the measurement of the distances by optics (e.g., laser).

As shown in Figure 14, an idea of isolating noises produced during the tamping process was proposed. In the figure, 1 presents double glazing, which has a better isolation of noise, and 3 is a brush, which does not damage the fastener and can sweep out ballast particles on the sleeper when the tamping machine is moving. Note that sweeping out ballast particles on sleepers can significantly reduce the ballast flight possibilities, which is a promising application for high-speed railway ballasted tracks.

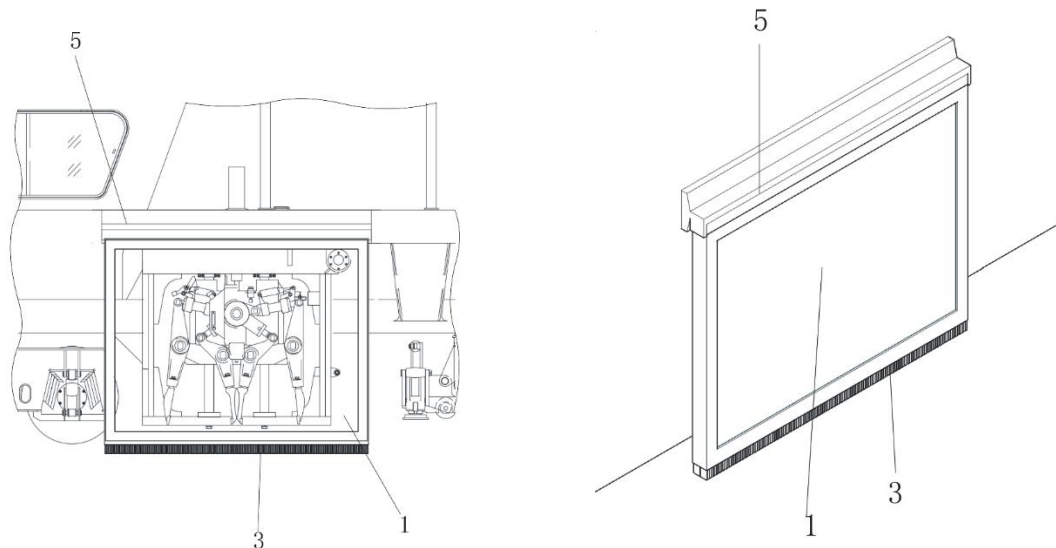

Figure 14 New tamping noise isolation idea

4.4. Tamping with a compactor for lateral resistance improvement

For lateral resistance improvement two methods can be used. One is combining dynamic track stabilization after tamping. Currently many tamping machines integrate dynamic track stabilization machines. The other uses the compactor machine, as shown in Figure 15.

According to the report [78], compacting ballast particles at sleeper cribs raises the resistance to lateral displacement by approximately 7%. Compacting the shoulder ballast particles raises the lateral resistance by 4%. The dynamic track stabilization machine is the most effective method for improving the lateral resistance, improving it by 30-40%.

In China, current tamping means use a tamping machine combined with a dynamic track stabilizer for normal maintenance. However, in regard to major maintenance (e.g., ballast bed renewal), the tamping and stabilization times are dependent on the track condition. Even though tamping breaks the ballast particles and stabilization compacts the ballast bed, it is not recommended to only use a dynamic track stabilizer for maintenance. Tamping is used to correct the track geometry irregularity, while the track

stabilizer is used to compact the ballast bed. If the ballast bed is not tamped into a uniform condition, stabilizing makes the ballast bed have a larger geometric irregularity. In addition, when the track-lifting height is larger than normal, the tamping times are set to 2-3 times, which frequently occurs in some special areas (soft/bad subgrade, turnouts).



Figure 15 Crib and shoulder ballast compacter (reproduced from [74, 85])

The compacter is used to compact the crib and shoulder ballast, applying vertical vibration to the ballast layer [85]. It was reported that 2-4 seconds of compacter operation can lead to a sufficient ballast layer performance. Moreover, the compacter increases the lateral resistance and helps keep the tamped track geometry for a longer time than the track without using a compacter [71].

4.5. Application of proper maintenance methods

The hanging sleeper and sleeper force distribution can be solved by applying proper maintenance methods. As shown in Figure 16, several maintenance methods other than tamping are given, including stone blowing, adjustable fasteners, self-correcting sleepers, side tamping and ballast cleaning.

Figure 16a shows the stone blowing machine [71, 86, 87], which applies air to blow small particles (approximately 20 mm) into the voids between the sleeper and ballast bed. It has the advantage of keeping the former ballast compaction underneath the gap (between the sleeper and ballast layer); in other words, it does not disturb the former ballast bed. For this, dynamic track stabilization is not necessary after stone blowing. Additionally, the settlement after stone blowing is not as high as that after tamping. It can be used for ballast beds with heavy fouling to avoid the line delay and ballast cleaning.

The disadvantages of stone blowing have four aspects, as follows.

- Low productivity. As shown in Table 4, the productivity is 350 m/h, which is much lower than tamping. It cannot be used for turnouts.
- Low track geometry correction. It cannot correct the track irregularity because the ballast bed is not loosened.
- Uncertain lateral resistance. Adding small particles can reduce the lateral resistance, while the undisturbed ballast bed retains a higher lateral resistance. The final lateral resistance is uncertain. Stone blowing reduces the lateral resistance by 50-65%, according to a previous report [78].
- The vertical stiffness can only correct small longitudinal differences.

Figure 16b shows the adjustable fastener, which is used for lifting up the rail for an even longitudinal track height. In [88], a finite element method model of the transition zone was built with the application of an adjustable fastener, together with experimental tests (unconfined pressure test), which proves that adjustable fasteners can reduce track degradation at the transition zones. The disadvantage of the adjustable fastener is that it loses its ability when the settlement is too large. In other words, the shims are not thick enough to provide larger lifts for the rail.

Figure 16c shows the self-correcting sleeper, which is used for lifting up the sleeper when differential settlements occur. It was first proposed in [89] for automatically filling the gaps of a hanging sleeper. The track under the cyclic loading test demonstrates that no hanging sleepers were found using the self-correcting sleeper. The disadvantage of this method is that when the settlement is too large the self-correcting sleeper cannot provide enough support to the rail. The principle of the self-correcting sleeper is similar to stone blowing. Therefore, the advantages and disadvantages are similar to stone blowing.

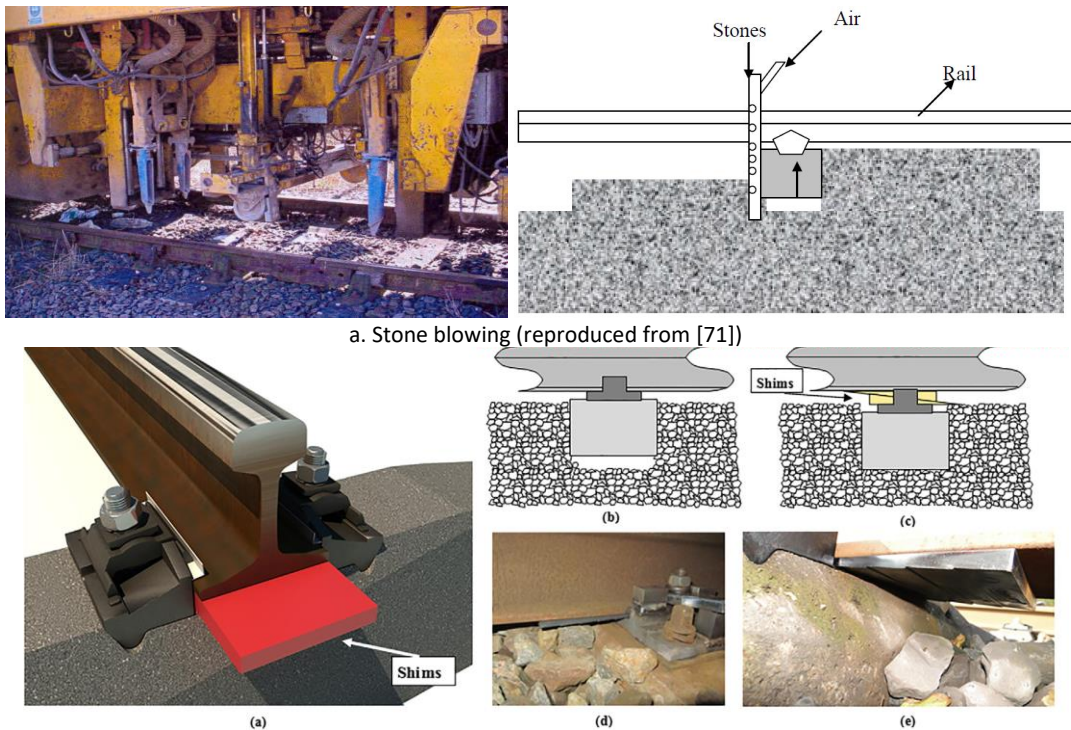

a. Stone blowing (reproduced from [71])

b. Adjustable fastener (reproduced from [88])

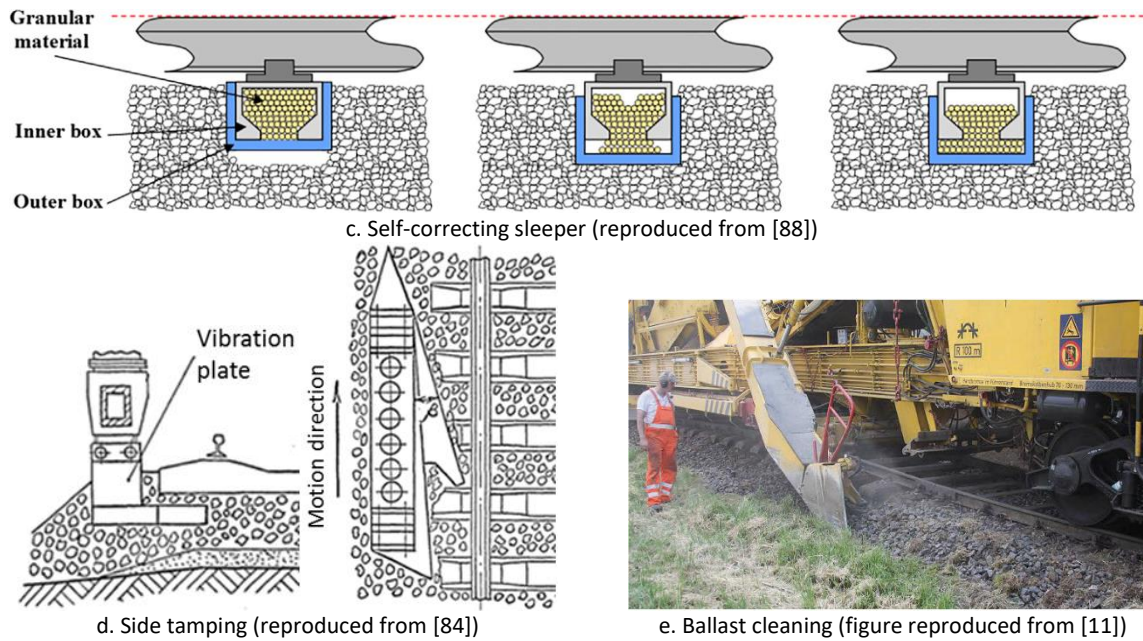

Figure 16 Examples of other maintenance methods

Figure 16d shows the side tamping, which applies another maintenance machine (side tamping machine) [84]. This was used in the former former Soviet Union. Ballast particles are moved to the bottom of the lifted sleepers by a wedge-shaped plate (with vibration), and the machine continuously moves along the track without stopping. The ballast particles that are moved to the sleeper bottom are uniform and compacted due to the horizontal vibration and complex shape of the wedges. This tamping method has the following advantages.

- High productivity. The maximum productivity is 3000 m/h, as shown in Table 4, which is higher than maintenance using tamping tines.
- Low ballast degradation. It does not penetrate the ballast bed, which leads to a lower ballast degradation.
- High track lifting. The track can be lifted up by 10 cm, which is helpful for tamping different layers. The tamping tine is short, and can only reach 10 cm under the sleeper.
- Suitable for many types of sleepers. This method may be used for many new sleepers, such as nailed sleepers, wing-shaped sleepers and ladder sleepers.

The disadvantages are as follows.

- This method is not suitable for tamping turnouts.
- Dynamic track stabilization is necessary after using side tamping.
- This method is not suitable to correct the track geometry.

Figure 16e shows the ballast cleaning machine, which is used to sieve out ballast fouling and fill in new ballast particles. It is applied when tamping has no effects or there is a too rapid ballast bed degradation after tamping. Ballast bed cleaning reduces the lateral resistance by approximately 50% [78]. For ballast bed cleaning on a large scale (long track distances), in China it is usually performed approximately every 10 years to replace all ballast particles. For small-scale ballast bed cleaning, ballast bed cleaning is manually performed. Fresh ballast particles are periodically added to the ballast bed; in particular, some

parts (frequent maintenance areas) need to add more ballast particles every year. In the past, ballast bed cleaning replaced all ballast particles with fresh ballast particles, while new ballast particles are currently added first, and then the fouling is sieved out. After ballast bed cleaning, tamping is performed immediately. However, stabilization is not necessary, because after ballast bed cleaning it is mandatory to restrict the train speed. Ballast cleaning belongs to major maintenance, which requires all departments (e.g., power supply) to cooperate together. The ballast bed position is changed to a large extent, which mainly influences the catenary, tunnel, and curve.

5. Perspectives and future maintenance trend

5.1. Tamping strategy in China

In this section some tamping questions in China are given. Based on the questions in China, some less-concerning but important questions are also discussed, which can be useful for other countries as perspectives.

Tamping cost. In China tamping costs are covered by the government, which means that the calculation is not precise. Tamping costs include human costs, machine costs (e.g., tamping tines) and material costs. For example, the tamping tine has a short lifespan (3-4 months), which is normally used for tamping 200-300 km ballast beds. The rough estimated cost is 10,000 RMB (Chinese currency) per kilometer.

Tamping cycle. In China, railway lines have four levels, which correspond to different tamping cycles, as shown in Table 5.

Table 5 Chinese railway line levels and the corresponding tamping cycles

Railway line level definition	Tamping cycles
Level 1: Operation speed over 120 km/h; Overall operation weight over 500 Mt (passenger dedicated line); Overall operation weight over 50 Mt (freight dedicated line).	1-2 years for the passenger dedicated line; 1.5-2.5 years for the freight dedicated line
Level 2: Operation speed 100-120 km/h; Overall operation weight over 30 Mt (freight dedicated line).	1.5-3 years
Level 3: Operation speed less than 100 km/h; Overall operation weight less than 30 Mt (freight dedicated line).	3-4 years
Level 4: Non-main line, branch line; arrival-departure track	Based on track conditions
Level 5: All others	Based on track conditions

The tamping cycle is decided by the track condition, which is evaluated by measuring the track geometry through the track gauge or inspection train. The inspection train confirms that the section requires tamping, while the track gauge is used to decide specific locations.

5.2. Perspectives

Tamping at special track structures. For the transition zone tamping is not performed. There is a special tamping machine for turnouts. For the curve, tamping depends on the radius, where a large radius curve is treated as a straight line. For the turnouts, the tamping cycle is the same as the normal line; however, it is not continuous because different tamping machines are separately operated. The normal tamping machine stops tamping approximately 50 meters before the turnouts. Theoretically, the tamping machine for turnouts takes over at 50 meters. However, in practice the accuracy is not high, which means that the overlap or gaps in tamping areas may exist.

Some special areas have very bad track conditions, which are mostly due to ballast problems. For example, the drainage at turnouts is not good, causing different subgrade stiffnesses. The different subgrade stiffnesses lead to different supports, which causes track irregularities. This is also a common phenomenon in soft subgrade regions; for example, in the Netherlands soft subgrade regions are present in large numbers. In other track structures the ballast bed condition is easy to maintain, where only spot issues occur.

For the mud-pumping ballast bed, it is not recommended to tamp frequently, which causes ballast bed failure more rapidly. For ballast beds on bridges, few tamping issues were found. The only problem occurs on an old kind of guardrail. For the new type of guardrail, it is easy to perform tamping.

Check after tamping. There are two types of checking after tamping. One is a static check, which uses the track gauge immediately after tamping (mandatory), and the other is a dynamic check, which uses the inspection train. Note that the inspection train and tamping are two different operation routines, which means that the inspection train is not mandatory after tamping. The inspection train is normally performed 1 or 1.5 months after tamping, but it is a rough estimated time. Note that the static check is in most cases sufficiently for evaluating the tamping effectiveness. In practice, if the track after a static check is shown to be sufficient, then the dynamic performance of the ballast track is in most cases sufficient.

Environmental influence. Temperature is the main concern during tamping since temperature influences the rail significantly. Tamping under high-temperature conditions is more prone to cause rail buckling, while rail fracture more easily occurs when tamping at low temperatures. Therefore, in China tamping is performed in spring (March to June) or autumn (September to November). Another environmental influence is the slope gradient. For the tamping machine, the limitation of the slope gradient is 3.3%, which means that the tamping machine cannot climb slopes with higher gradients (over 3.3%). Other means of tamping are needed, such as manual tamping.

5.3. Future maintenance trend

The future maintenance trend is towards the directions of a higher efficiency and accuracy, more instruments and automatic processes.

- Efficiency and accuracy. A higher efficiency means rapid maintenance, and a higher accuracy means different tamping processes (e.g., vibration frequency, amplitude, squeezing duration) for different ballast beds (e.g., new ballast or existing line renewal).
 - Developing tamping machines (tamping units) into a higher operation with a good maintenance quality is the first priority.
 - Even though tamping machine knowledge is controlled, an increasing number of technologies from pavement engineering or rock and soil engineering can be used to build new tamping machines, e.g., soil compactors [25].
 - Tamping tine motions (squeezing, elliptical or torsional movements) are limited. More movements with complex motions are a development direction.
 - A deeper understanding of the tamping mechanism is very helpful for increasing the efficiency and accuracy.
 - Concerning the DEM models, the model size should be larger than earlier models because the boundary condition decides the simulation results. In addition, the ballast particles

- are made as real as possible, such as the particle shape and particle degradation. Most importantly, shortening the computation duration still requires more development.
- The stabilization process is performed immediately after tamping, which costs more time. The idea is that using the tamping can directly make the ballast bed restore its initial best performance without the stabilization process.
 - If tamping is inevitable, a reasonable tamping cycle estimation should be precisely made based on the key factors, such as the transportation type, ballast size and shape, track structure, ballast material and weather.
- More instruments are being developed or more instruments are being used to better study or perform tamping.
 - The mechanism of tamping is still not clear, and more instruments are available for necessary data measurement (especially forces) in each step of the tamping process. For example, how great is the penetration forces of the tamping tine? How great are the squeezing forces? How seriously does penetration and squeezing cause ballast degradation, and especially ballast breakage?
 - Instruments that can measure the bulk density of ballast beds and ballast bed stability (stiffness and lateral and longitudinal resistances to sleepers) are needed for tamping the quality evaluation. The idea is that the instruments are equipped on the tamping machine, which can evaluate the track quality immediately after tamping. The instruments can be, for example, ground penetration radar and hammer test systems.
 - The tamping quality evaluation methods are quite limited and can be developed not only from the current most-used track data (track geometry) but also by using more advanced instruments to create new indices. Advanced instruments can include laser scanning, drones and data from structural health monitoring [90]; for example, an instrument (equipped on a tamping machine) can immediately examine the ballast bed dynamic performance (under cyclic loading).
 - More instruments can be developed to reduce damage to the ballast particles, for example, rubber-covered tamping tines.
 - Another developing trend is to invent a new tamping machine for spot maintenance instead of for whole-line maintenance to reduce the maintenance costs.
 - Developing new tamping machines with a lower noise is necessary, such as machines similar to stone blowers, which may not use vibration to tamp the ballast beds. Vibration not only results in loud noises, but also damages ballast particles.
 - Developing a new tamping machine that can be used for all types of track structures, such as ladder sleepers, polyurethane-enforced ballast beds and nailed sleepers is a research direction.
 - The automatic process means that tamping is automatically performed and controlled by the computer with less man-machine interaction.
 - The automatic process can evaluate ballast particle damage using laser scanning to obtain 3D ballast bed profiles and 3D ballast particle images, such as the studies in [83, 91].
 - The automatic process can also automatically adjust the tamping tine vibration frequency, amplitude, squeezing duration and times, which are based on the ballast bed properties, such as the ballast material, ballast bed profile and new or old ballast.

- Automatic processes can also automatically drive the tamping unit, for example, the penetration locations of tamping tines with the laser or other optical means for location adjustment.
- The automatic process can also combine the ballast replacement machine, which means that the steps are combined, i.e., inspection-ballast replacement-tamping-stabilization.

Acknowledgements

This study is supported by the China Academy of Railway Science funding (2020YJ081). We would like to thank Jikun Li (Beijing Railway Bureau) for providing valuable engineering experiences on railway maintenance.

References

- [1] D. Li, J. Hyslip, T. Sussmann, S. Chrismer, *Railway geotechnics*, CRC Press 2002.
- [2] J. Liu, P. Wang, G. Liu, J. Xiao, H. Liu, T. Gao, Influence of a tamping operation on the vibrational characteristics and resistance-evolution law of a ballast bed, *Construction and Building Materials* 239 (2020) 117879.
- [3] B. Indraratna, T. Ngo, *Ballast railroad design: smart-uow approach*, CRC Press 2018.
- [4] B. Indraratna, N.T. Ngo, C. Rujikiatkamjorn, Behavior of geogrid-reinforced ballast under various levels of fouling, *Geotextiles and Geomembranes* 29(3) (2011) 313-322.
- [5] Y.L. Guo, V. Markine, W.L. Qiang, H. Zhang, G.Q. Jing, Effects of crumb rubber size and percentage on degradation reduction of railway ballast, *Construction and Building Materials* 212 (2019) 210-224.
- [6] H. Huang, E. Tutumluer, Discrete Element Modeling for fouled railroad ballast, *Construction and Building Materials* 25(8) (2011) 3306-3312.
- [7] J.-L. Xiao, P. Jing, S.-X. Yu, P. Wang, Analysis on the track quality evolution law of polyurethane-reinforced ballasted track in high-speed railway, *Proceedings of the Institution of Mechanical Engineers, Part F: Journal of Rail and Rapid Transit* (2020).
- [8] G.Q. Jing, L.C. Qie, V. Markine, W.L. Jia, Polyurethane reinforced ballasted track: Review, innovation and challenge, *Construction and Building Materials* 208 (2019) 734-748.
- [9] G. Jing, P. Aela, H. Fu, The contribution of ballast layer components to the lateral resistance of ladder sleeper track, *Construction and Building Materials* 202 (2019) 796-805.
- [10] A. Paixão, E. Fortunato, Abrasion evolution of steel furnace slag aggregate for railway ballast: 3D morphology analysis of scanned particles by close-range photogrammetry, *Construction and Building Materials* 267 (2021).
- [11] J. Neuhold, *Tamping within sustainable track asset management*, Graz University of Technology, 2020.
- [12] A. Bakhtiary, J.A. Zakeri, S. Mohammadzadeh, An opportunistic preventive maintenance policy for tamping scheduling of railway tracks, *International Journal of Rail Transportation* 9(1) (2021) 1-22.
- [13] G. Jing, M. Siahkouhi, J. Riley Edwards, M.S. Dersch, N.A. Hoult, Smart railway sleepers - a review of recent developments, challenges, and future prospects, *Construction and Building Materials* 271 (2021).
- [14] K. Zeng, T. Qiu, X.C. Bian, M. Xiao, H. Huang, Identification of ballast condition using SmartRock and pattern recognition, *Construction and Building Materials* 221 (2019) 50-59.
- [15] J.J. Kumara, K. Hayano, Deformation characteristics of fresh and fouled ballasts subjected to tamping maintenance, *Soils and Foundations* 56(4) (2016) 652-663.
- [16] E.N. Martey, N. Attoh-Okine, Modeling tamping recovery of track geometry using the copula-based approach, *Proceedings of the Institution of Mechanical Engineers, Part F: Journal of Rail and Rapid Transit* 232(8) (2018) 2079-2096.

- [17] Y. Lijun, L. Yunzhao, Research on a new type. tamping device integrating tamper and stabilizer, *Construction Machinery and Equipment* 6 (2008).
- [18] E. Azéma, Etude numérique des matériaux granulaires à grains polyédriques: rhéologie quasi-statique, dynamique vibratoire, application au procédé de bourrage du ballast, Université Montpellier, 2007.
- [19] S. Aingaran, L. Le Pen, A. Zervos, W. Powrie, Modelling the effects of trafficking and tamping on scaled railway ballast in triaxial tests, *Transportation Geotechnics* 15 (2018) 84-90.
- [20] B. Aursudkij, A laboratory study of railway ballast behaviour under traffic loading and tamping maintenance, University of Nottingham, 2007.
- [21] B. Feng, Design and Simulation Study of tamping mechanism test device[D], Southwest Jiaotong University, 2014.
- [22] T. Zhou, Study on mechanical properties and parameter optimization of tamping on high speed ballast railway (in Chinese), Kunming University of Science and Technology, 2017.
- [23] R. Boyer, W. Jones, State-of-the-Practice: rubblization of heavy load concrete airfield pavements, *Airfield Pavements: Challenges and New Technologies* 2004, pp. 424-435.
- [24] C.H. Dowding, C. Dowding, *Construction vibrations*, Prentice Hall Upper Saddle River, NJ1996.
- [25] K. Terzaghi, R.B. Peck, G. Mesri, *Soil mechanics in engineering practice*, John Wiley & Sons1996.
- [26] T.S. Yoo, E.T. Selig, Dynamics of Vibratory-Roller Compaction, *J Geotech Eng-Asce* 105(10) (1979) 1211-1231.
- [27] G. Jing, D. Ding, X. Liu, High-speed railway ballast flight mechanism analysis and risk management – A literature review, *Construction and Building Materials* 223 (2019) 629-642.
- [28] H. Thurner, New compaction concept, 17th World Road Congress, , Sydney, Australia, 1984.
- [29] G.Q. Jing, P. Aela, Review of the lateral resistance of ballasted tracks, *P I Mech Eng F-J Rai* 234(8) (2020) 807-820.
- [30] Y.L. Guo, L. Zong, V. Markine, X.Y. Wang, G.Q. Jing, Experimental and numerical study on lateral and longitudinal resistance of ballasted track with nailed sleeper, *International Journal of Rail Transportation* (2021) 1-19.
- [31] S. Shi, L. Gao, H. Xiao, Y. Xu, H. Yin, Research on ballast breakage under tamping operation based on DEM–MBD coupling approach, *Construction and Building Materials* 272 (2021).
- [32] E. Tutumluer, H. Huang, Y. Hashash, J. Ghaboussi, Aggregate shape effects on ballast tamping and railroad track lateral stability, AREMA Annual Conference, Louisville, KY, Sept, 2006, pp. 17-20.
- [33] M. Sysyn, V. Kovalchuk, U. Gerber, O. Nabochenko, A. Pentsak, Experimental study of railway ballast consolidation inhomogeneity under vibration loading, *Pollack Periodica* 15(1) (2020) 27-36.
- [34] M. Sysyn, O. Nabochenko, V. Kovalchuk, U. Gerber, Evaluation of Railway Ballast Layer Consolidation after Maintenance Works, *Acta Polytechnica* 59(1) (2019) 77-87.
- [35] M. Sol-Sánchez, F. Moreno-Navarro, M.C. Rubio-Gámez, Analysis of ballast tamping and stone-blowing processes on railway track behaviour: the influence of using USPs, *Géotechnique* 66(6) (2016) 481-489.
- [36] C. Paderno, Improving ballast tamping process, Proc., World Congress on Railway Research, 2011, pp. 1-6.
- [37] S. Offenbacher, B. Antony, O. Barbir, F. Auer, M. Landgraf, Evaluating the applicability of multi-sensor equipped tamping machines for ballast condition monitoring, *Measurement* 172 (2021).
- [38] T. Zhou, B. Hu, J. Sun, Z. Liu, Discrete element method simulation of railway ballast compactness during tamping process, *Open Electrical & Electronic Engineering Journal* 7 (2013) 103-109.
- [39] R. Perales, G. Saussine, N. Milesi, F. Radjai, Numerical investigation of the tamping process, 9th World Congress on Railway Research, 2011.
- [40] G. Saussine, E. Azema, R. Perales, F. Radjai, Compaction of Railway Ballast During Tamping Process: a Parametric Study, AIP Conference Proceedings, AIP, 2009, pp. 469-472.

- [41] Y. Descantes, R. Perales, G. Saussine, N. Milesi, On the damaging effects of the ballast tamping operation, AIPCR, 2011, p. sp.
- [42] G. Saussine, E. Azéma, P. Gautier, R. Peyroux, F. Radjai, Numerical modeling of the tamping operation by Discrete Element Approach, World Congress Rail Research, 2008, pp. 1-9.
- [43] T.Y. Zhou, B. Hu, X.J. Wang, B. Yan, Discrete Element Method Analysis of Mechanical Properties of Railway Ballast during Tamping Process under Different Amplitude, Applied Mechanics and Materials 233 (2012) 224-227.
- [44] D.-I.O. Barbir, SEMI-ANALYTICAL APPROACH TO BALLAST BED MODELLING DURING COMPACTION, 27th European Young Geotechnical Engineers, Mugla, Turkey, 2019.
- [45] T.Y. Zhou, B. Hu, B. Yan, J.F. Sun, Experimental and Numerical Study of Railway Ballast Compactness during Tamping Process, Advanced Materials Research 690-693 (2013) 2730-2733.
- [46] Z. Zhi-ping, S. Shan-yi, W. Wei-dong, Y. Hai-jian, W. Guo-shu, Resistance Characteristics of Ballast Bed in Different Stamping Stages, Electronic Journal of Geotechnical Engineering.
- [47] O. Barbir, D. Adam, F. Kopf, J. Pistor, F. Auer, B. Antony, Development of condition-based tamping process in railway engineering, ce/papers 2(2-3) (2018) 969-974.
- [48] S.C. Douglas, Ballast Quality and Breakdown during Tamping, Proceedings of the 2013 American Railway Engineering and Maintenance-of-Way Association Conference. Indianapolis, IN, 2013.
- [49] J. Kumara, K. Hayano, Model tests on settlement behaviour of ballasts subjected to sand intrusion and tie tamping application, Proc., 18th International Conference on Soil Mechanics and Geotechnical Engineering, Paris, France, 2013, pp. 1305-1308.
- [50] T. JOSEF, Ballast tamping machine and method for tamping a railway Track:(AT) EP, 1403433A3.
- [51] C. YVO, D. YVAN, Railway track tamping device:(CH) EP, 0050889A1.
- [52] C. Min, G. Gong, Y. Liu, Design and simulation research on new tamper based on ADAMS, 2010 International Conference on Digital Manufacturing & Automation, IEEE, 2010, pp. 494-498.
- [53] J. Morgan, P. Youngman, Single shaft tamper with reciprocating rotational output, Google Patents, 2002.
- [54] Y. Liu, G. Gong, H. Yang, D. Han, H. Wang, Regulating characteristics of new tamping device exciter controlled by rotary valve, IEEE/ASME Transactions on Mechatronics (2015) 1-1.
- [55] O. BARBIR, D. ADAM, F. KOPF, J. PISTRO, F. AUER, B. ANTONY, In-situ measurements and a semi-analytical approach to ballast bed modelling during compaction.
- [56] P.B. Franz, Tamping machine for tamping ballast under the sleepers of a railway track [P], EP1070787, 2001.
- [57] B. Knoll, Use of Track Geometry Recording and Tamping Intervention Levels for Optimum Track Geometry Durability, ÖBB Infrastruktur Bau AG.
- [58] C. Vale, I.M. Ribeiro, R. Calçada, Integer programming to optimize tamping in railway tracks as preventive maintenance, Journal of Transportation Engineering 138(1) (2011) 123-131.
- [59] C. Vale, I.M. Ribeiro, Railway Condition-Based Maintenance Model with Stochastic Deterioration, Journal of Civil Engineering and Management 20(5) (2014) 686-692.
- [60] L.F. Caetano, P.F. Teixeira, Predictive maintenance model for ballast tamping, Journal of Transportation Engineering 142(4) (2016) 04016006.
- [61] T. Zhou, B. Hu, J. Sun, Study of Railway Ballast Compactness under Tamping Operation, JApSc 13(11) (2013) 2072-2076.
- [62] T.Y. Zhou, B. Hu, X.J. Wang, B. Yan, Discrete Element Method Analysis of Mechanical Properties of Railway Ballast during Tamping Process under Different Vibration Frequency, Applied Mechanics and Materials 190-191 (2012) 369-372.
- [63] T.Y. Zhou, B. Hu, B. Yan, P. Xu, Discrete Element Method Simulation of Mesomechanics of Railway Ballast during Tamping Process, Advanced Materials Research 690-693 (2013) 2726-2729.

- [64] T.Y. Zhou, B. Hu, X.Y. Zhao, B. Yan, Numerical Study Porosity of Railway Ballast during Tamping Process, *Advanced Materials Research* 919-921 (2014) 1124-1127.
- [65] G. Saussine, E. Azema, R. Perales, F. Radjai, Compaction of Railway Ballast During Tamping Process: a Parametric Study, *Powders and Grains* 1145 (2009) 469.
- [66] S. Shi, L. Gao, X. Cai, H. Yin, X. Wang, Effect of tamping operation on mechanical qualities of ballast bed based on DEM-MBD coupling method, *Computers and Geotechnics* 124 (2020).
- [67] X.J. Wang, Y.L. Chi, W. Li, T.Y. Zhou, X.L. Geng, The research of the numerical simulation on the granular ballast bed tamping, *Advanced Materials Research, Trans Tech Publ*, 2012, pp. 1395-1398.
- [68] X.J. Wang, Y.L. Chi, W. Li, T.Y. Zhou, Study on the DEM Simulation of the Granular Railway Ballast Bed Tamping, *Advanced Materials Research* 524-527 (2012) 3256-3259.
- [69] Z. Wang, Y. Xu, H. Wang, L. Qie, Y. Xu, Study on Influence Laws of Working Parameters of Heavy-duty Maintenance Machinery Tamping on Tamping Effect, *Railway Engineering* 60(1) (2020) 129-133.
- [70] M. Ball, *Railway Ballast Maintenance*, Final year project, School of Science and the Environment, Coventry University (2003).
- [71] C. Calla, *Two layered ballast system for improved performance of railway track*, Coventry University, 2003.
- [72] G.R. McDowell, W.L. Lim, A.C. Collop, R. Armitage, N.H. Thom, Laboratory simulation of train loading and tamping on ballast, *P I Civil Eng-Transp* 158(2) (2005) 89-95.
- [73] Y. Xu, W. Yu, L. Qie, H. Wang, N. Ning, Analysis of influence of ballast shape on abrasion resistance using discrete element method, *Construction and Building Materials* 273 (2021).
- [74] Matisa, *Track auscultation concepts and technologies*, https://www.matisa.ch/brochures_pdf/en/pre_t pour_demain_en.pdf.
- [75] R. Wenty, Plasser & Theurer machines and technologies applied for track maintenance of high-speed railway lines: a selection, *Rail Engineering International* 36(1) (2007).
- [76] M. Sol-Sánchez, F. Moreno-Navarro, M. Rubio-Gámez, N. Manzo, V. Fontseré, Full-scale study of Neoballast section for its application in railway tracks: optimization of track design, *Materials and Structures* 51(2) (2018) 43.
- [77] N.R.o.P.s.R.o. China, *Maintenance safety code for normal speed railway* (in Chinese), China Railway Publishing House, Beijing, 2014.
- [78] B. Lichtberger, The lateral resistance of the track (Part 2), *J European Railway Review* (2007).
- [79] R.P. De Bold, *Non-destructive evaluation of railway trackbed ballast*, University of Edinburgh, 2011.
- [80] L. Chang, R.P. Dollevoet, R.F. Hanssen, Nationwide railway monitoring using satellite SAR interferometry, *IEEE Journal of Selected Topics in Applied Earth Observations and Remote Sensing* 10(2) (2017) 596-604.
- [81] Y. Qian, *Funded Ph.D. student position*; https://sc.edu/study/colleges_schools/engineering_and_computing/faculty-staff/qian_yu.php 2020.
- [82] L. Chang, N.P. Sakpal, S.O. Elberink, H. Wang, Railway Infrastructure Classification and Instability Identification Using Sentinel-1 SAR and Laser Scanning Data, *Sensors (Basel)* 20(24) (2020).
- [83] J. Sadeghi, M.E.M. Najjar, J.A. Zakeri, C. Kuttelwascher, Development of railway ballast geometry index using automated measurement system, *Measurement* 138 (2019) 132-142.
- [84] M. Przybyłowicz, M. Sysyn, V. Kovalchuk, O. Nabochenko, B. Parneta, Experimental And Theoretical Evaluation Of Side Tamping Method For Ballasted Railway Track Maintenance, *Transport Problems* 15(3) (2020) 93-106.
- [85] E.T. Selig, J.M. Waters, *Track geotechnology and substructure management*, Thomas Telford 1994.
- [86] A.A. Abrashitov, A.V. Semak, Experimental Investigation of Railway Maintenance with Stoneblowing Techniques, *Transportation Soil Engineering in Cold Regions* 2020, pp. 19-26.
- [87] P. McMichael, A. McNaughton, *The Stoneblower-Delivering the Promise: Development, Testing and Operation of a New Track Maintenance System*, TRB 2003 Annual Meeting CD-ROM, 2003.

- [88] H. Wang, V. Markine, Corrective countermeasure for track transition zones in railways: Adjustable fastener, *Engineering Structures* 169 (2018) 1-14.
- [89] K. Muramoto, T. Nakamura, T. Sakurai, A study of the effect of track irregularity prevention methods for the transition zone between different track structures, *Quarterly Report of RTRI* 53(4) (2012) 211-215.
- [90] P.C. Chang, A. Flatau, S.C. Liu, Review Paper: Health Monitoring of Civil Infrastructure, *Structural Health Monitoring* 2(3) (2016) 257-267.
- [91] Y. Guo, V. Markine, J. Song, G. Jing, Ballast degradation: Effect of particle size and shape using Los Angeles Abrasion test and image analysis, *Construction and Building Materials* 169 (2018) 414-424.