

## **A comparative sustainability evaluation of alternative configurations of an urban nitrogen removal solution targeting different pathways**

Pryce, David; Kapelan, Zoran; Memon, Fayyaz A.

**DOI**

[10.1016/j.jclepro.2022.135619](https://doi.org/10.1016/j.jclepro.2022.135619)

**Publication date**

2023

**Document Version**

Final published version

**Published in**

Journal of Cleaner Production

**Citation (APA)**

Pryce, D., Kapelan, Z., & Memon, F. A. (2023). A comparative sustainability evaluation of alternative configurations of an urban nitrogen removal solution targeting different pathways. *Journal of Cleaner Production*, 384, Article 135619. <https://doi.org/10.1016/j.jclepro.2022.135619>

**Important note**

To cite this publication, please use the final published version (if applicable). Please check the document version above.

**Copyright**

Other than for strictly personal use, it is not permitted to download, forward or distribute the text or part of it, without the consent of the author(s) and/or copyright holder(s), unless the work is under an open content license such as Creative Commons.

**Takedown policy**

Please contact us and provide details if you believe this document breaches copyrights. We will remove access to the work immediately and investigate your claim.



# A comparative sustainability evaluation of alternative configurations of an urban nitrogen removal solution targeting different pathways

David Pryce<sup>a,\*</sup>, Zoran Kapelan<sup>b,a</sup>, Fayyaz A. Memon<sup>a</sup>

<sup>a</sup> College of Engineering, Mathematics, and Physical Sciences, University of Exeter, EX4 4QF, United Kingdom

<sup>b</sup> Department of Water Management, Delft University of Technology, Stevinweg 1, 2628CN, Delft, Netherlands

## ARTICLE INFO

Handling Editor: Panos Seferlis

### Keywords:

Wastewater treatment  
Water pollution  
Environmental impact  
Economic comparison

## ABSTRACT

Limiting the introduction of excess nitrogen to natural water sources is a growing priority for water security and environmental health. This poses particular difficulties in urban environments where available land for potential solutions is limited. A promising option is the integrated fixed-film activated sludge (IFAS) process that requires only a small footprint and is capable of high total nitrogen (TN) removal through multiple pathways. In light of the sustainable development goals set out by the United Nations, the present work has sought to compare the sustainability of two TN removal pathways by comparing the technical, economic and environmental performance of their optimum configurations. Through modelling, a single-stage configuration demonstrated the capacity to achieve an effluent TN concentration of 8.7 mg/L by the simultaneous nitrification denitrification pathway when a dissolved oxygen concentration of 3.5 mg/L was provided. Addition of a post-anoxic stage at equal volume to the aerobic stage (1:1 aerobic to anoxic ratio) to target conventional nitrification denitrification could realise an effluent TN concentration of 4.2 mg/L when DO was increased to 4.5 mg/L, although 5.8 mg/L of effluent TN could be achieved with only a 5:1 ratio. In terms of environmental burden and economic costs, analysis of the system's life-cycle under these different configurations indicated considerable asymmetry of the two pathways during the operational phase due mainly to the increased aeration. However in spite of this, the two conventional configurations were ultimately both shown to be more sustainable than that of the simultaneous pathway due to the greater TN removal capacity afforded.

## 1. Introduction

Global urbanization is placing increasing pressure on governments to improve urban infrastructure to protect available water resources without compromising the sustainable development goals (SDGs) set out by the United Nations (Zhang et al., 2019). A key threat to water security is the ongoing introduction of excess nitrogen to natural water bodies (Yu et al., 2019), even garnering support for its own SDG to be established being at the route of many human and environmental health issues (Sutton et al., 2021). Biological wastewater treatment has long been established as an effective means for mitigating water-borne nitrogen and its application continues to draw focus (Holmes et al., 2019). However, tightening discharge standards and sprawling urban centres are demanding greater performance from such technologies but in a smaller space. This poses additional challenges for priorities of sustainability where the most sustainable options tend to be passive and spacious such as constructed wetlands (Molinos-Senante et al., 2014).

Where the use of high-impacting and expensive technologies are unavoidable under the overarching priority of technical performance, opportunities to enhance sustainability must be fully exploited where possible.

One technology suited to the urban environment is the integrated fixed-film activated sludge (IFAS) process that offers strong nitrogen removal in a relatively small footprint (Singh et al., 2015). Being characterised by high quantities of functional biomass, the IFAS system affords a higher throughput of wastewater when compared to more common biological technologies such as the activated sludge (AS) process (Rosso et al., 2011). Due to the robust nature of the biomass, the system is highly configurable and can be modified to better treat target pollutants in both a centralized and decentralized role. In the case of total nitrogen (TN), the addition of an anoxic tank can better facilitate denitrification thereby reducing effluent nitrate (NO<sub>3</sub>) for greater overall treatment (Farazaki and Gikas, 2019). Alternatively, dissolved oxygen (DO) levels can be reduced in the aerobic tank to encourage

\* Corresponding author.

E-mail address: [dgp206@exeter.ac.uk](mailto:dgp206@exeter.ac.uk) (D. Pryce).

simultaneous nitrification denitrification (SND) without the need for an additional stage. The phenomenon of SND was demonstrated in a packaged IFAS system by Singh et al. (2016) in previous work, and was attributed to lower oxygen penetration in the bacterial colonies permitting the necessary anoxic zone for denitrifiers to proliferate (Cao et al., 2017). While both configurations each have their merits, it is not yet understood how they compare in terms of sustainability.

While multiple studies have attempted to compare the sustainability of alternative wastewater treatment technologies (Molinos-Senante et al., 2014; Mena-Ulecia and Hernández, 2015; Plakas et al., 2016; Akhouni and Nazif, 2018; Delanka-Pedige et al., 2021), little work has made sustainability comparisons at the configurational level. One study by Singh et al. (2017) compared the environmental impact of the construction phase of a packaged IFAS system and seven aeration strategies, finding continuous aeration at the highest DO concentration (4.5 mg/L) to be the most impacting in almost all impact categories. Recent work by the authors extended this study to incorporate treatment performance with the life-cycle costs of each aeration strategy to analyse their sustainability (Pryce et al., 2022b). The results indicated a distinct trade-off between eco-efficiency and performance across the different DO concentrations. This suggested that a better DO balance was to be identified between performance and cost, such that may be afforded by the optimal operational configuration to promote SND. In contrast, a greater treatment performance is expected to be achieved by the two-stage configuration designed to maximize both nitrification and denitrification processes without conflict (Farazaki and Gikas, 2019). However, achieving this higher level of TN removal performance will necessitate further tank construction and a higher rate of aeration that will incur additional environmental and economic costs. After all, previous work has indicated the two-stage process to be a less sustainable TN removal pathway when compared to more energy-efficient process types such as anammox (Lin et al., 2016).

The present work seeks to evaluate and compare the sustainability of a packaged IFAS system when utilizing different TN removal strategies, using the recently developed tri-factor sustainability index (TFSI) that is an extension of the widely-used eco-efficiency assessment (Pryce et al., 2022b). The TFSI assesses sustainability from the perspective of environmental burden, system economy and technical performance (Pryce et al., 2022b). As such, the objectives of the study are as follows:

- 1 - Identify the configurations of greatest TN removal performance by way of a previously-developed process model (Pryce et al., 2022a).
- 2 - Evaluate the environmental impact of each configuration by way of life-cycle impact assessment (LCIA).
- 3 - Evaluate the relative economic costs of each configuration by way of life-cycle cost analysis (LCCA).
- 4 - Calculate and compare the TFSI scores to identify the most sustainable configuration of the packaged IFAS system when targeting enhanced TN removal.

To the best of our knowledge, no work has yet sought to identify the most sustainable IFAS configuration for nitrogen mitigation in an urban environment. It is hoped the findings of this study may better inform the sustainable development of future urban wastewater management and assist efforts to realise the water and environment-related SDGs by 2030.

## 2. Methodology

### 2.1. Goal and scope descriptions

With the aim of identifying the most efficient operational strategy for TN removal in a single-stage configuration, the present work investigated the best combination of two parameters (DO concentration and recycle activated sludge (RAS) rate). To identify the most efficient strategy for maximized TN removal when incorporating an anoxic tank in the configuration, the best combination of anoxic tank volume and

DO concentration were investigated. In both instances, only values that did not compromise effluent limits of other key pollution parameters such as biological oxygen demand (BOD) and total suspended solids (TSS) were considered. Limits were set according to Indian standards (MoEFCC, 2015), with BOD <30 mg/L and TSS <100 mg/L. The investigated ranges and resolutions for the single-stage system (i.e. single aerobic reactor) study were DO concentration = 0.0–6.0 mg/L ( $\Delta$  0.5 mg/L) and relative RAS rate = 0 – 2Q ( $\Delta$  0.125Q), where Q (flow rate) = 69.6 m<sup>3</sup>/d. For the two-stage system (i.e. aerobic reactor followed by anoxic reactor) study these were DO concentration = 0.0–4.5 mg/L ( $\Delta$  0.5 mg/L) and anoxic tank volume = 0–20 m<sup>3</sup> ( $\Delta$  0.5 m<sup>3</sup>).

With the aim of assessing the relative life-cycle costs of each configuration, the system boundary considered the construction and operational phases while the functional unit was taken as 1 m<sup>3</sup> treated wastewater. A service life of 15 years was assumed as is commonly used for wastewater treatment structures (Vlasopoulos et al., 2006).

### 2.2. Study system

The study was based on a small, decentralized IFAS system that had previously been the subject of intense trials at a sewage pumping station in Rishikesh, India (Singh et al. 2015, 2016, 2017; Bhatia et al., 2017). In short, an aerobic chamber was coupled only with a post-settlement tank without pre-treatment. A portion of the settled sludge was recycled for activation to promote growth of longer-living nitrifiers for greater TN removal. Media was also attached in the aerobic chamber to further encourage nitrifier proliferation as well as other functional bacteria groups within the colonies.

As reported by Singh et al. (2015), air was delivered by a 50 m<sup>3</sup>/h blower and 4 Aquaconsult AEROSTRIP® fine bubble membrane diffusers, while the reactor contained 64 Biotextil Cleartec® media sheets (2.7 m × 0.96 m). Fig. 1 displays each of the individual components. As described by Singh et al. (2015), fixed operational parameters included a hydraulic retention time (HRT) of 6.9 h and a waste activated sludge (WAS) rate of 1.1 m<sup>3</sup>/d. Ambient and influent temperature were given as 26 °C.

For the present work, influent composition is based on actual municipal wastewater treated by the modelled system in Rishikesh, India (Singh et al., 2015). Model influent is presented in Table 1, while details of the influent characterization can be found in previous work (Pryce et al., 2022a).

In the absence of an anoxic chamber it is considered that all denitrification is taking place within the aeration chamber. While in reality it can be assumed that some denitrification would be occurring in the settlement tank (Crabtree, 1983), this is likely to be negligible as denitrification in the settlement tank is known to be the primary cause for floating sludge that would adversely affect removal performance of other pollutants such as BOD and TSS (Henze et al., 1993). This phenomenon was recorded by Singh et al. (2015) during start-up of the investigated IFAS system, but not at steady-state.

### 2.3. Model development

The steady-state model was developed in the GPS-X™ software (Hydromantis, 2022) and calibrated as according to previous work (Pryce et al., 2022a). In short, influent and effluent data was used from a study by Singh et al. (2015) that investigated the treatment performance of the IFAS during start-up and steady state. Operational settings such as influent flow rate (Q) and waste activated sludge (WAS) rate were used from the latter state (Singh et al., 2015). The model was validated on further influent and effluent data used in a later study on the same system investigating the influence of DO stress on its performance (Singh et al., 2016). For further details regarding all aspects of the model development, calibration and uncertainty, readers are referred to the proceeding work (Pryce et al., 2022a).

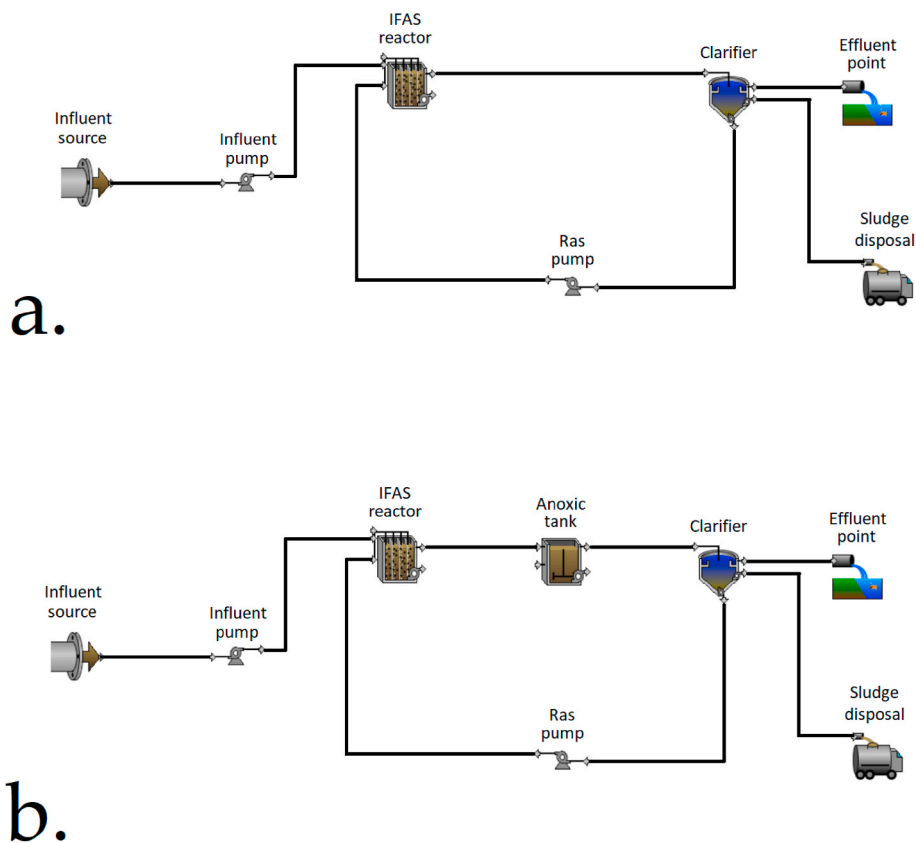

Fig. 1. Modelled IFAS system diagram, a. single-stage configuration and b. Two-stage configuration.

**Table 1**  
Influent characteristics of the IFAS system used in the present study and results of the model validation with calculated error (Pryce et al., 2022a).

Parameter	Unit	Influent	Effluent (observed)	Model output (validation)	Model error %
pH	-	7.2 ± 0.2	7.2 ± 0.2	7.2	-
Temperature	°C	23.0 ± 2.0	23.0 ± 2.0	23.0	-
System pressure	atm	1	1	1	-
Mass flow rate (Q)	m <sup>3</sup> /d	69.6	69.6	69.6	-
Chemical oxygen demand	mg/L	440.4 ± 25.7	25.5 ± 1.7	24.2	5.1
Biological oxygen demand	mg/L	221.6 ± 18.4	10.7 ± 0.9	10.2	4.7
Total suspended solids	mg/L	262.9 ± 27.6	15.0 ± 3.6	15.8	5.0
Ammonia	mg/L	34.5 ± 9.6	0.2 ± 0.2	0.2	0.0
Total nitrogen	mg/L	45.9 ± 11.6	14.2 ± 1.3	14.9	4.7

2.4. TN treatment profiling

The present study sought to map the TN removal model across all possible combinations of parameters within the investigated range. Due to the small size of dataset in the present investigation, it was possible to obtain values for all parameter combinations at a moderate resolution which provided sufficient insight into the pollutant profile. It was also necessary to understand the influence of design and operational changes

on other critical pollutants (TSS, BOD) to ensure these were not compromised in pursuit of enhanced TN removal. Once these values for each of the investigated pollutants were obtained from the model output, they could then be visualised as 3D and 2D plots to identify optimum settings.

2.5. Environmental impact assessment (EIA)

To generate environmental scores, a streamlined life cycle analysis (LCA) was performed. An inventory was first compiled to reflect the materials, processes and energy required for each design measure as shown by example in Table S1 of the Supplementary material. With regards to the impact incurred for each volume of anoxic tank considered, the stainless steel and welding required were calculated as demonstrated in Section S2 of the supplementary material. The impact of the anoxic stirrer itself was not considered due to the high variability of designs between manufacturers, but energy requirement was included. This was taken as 0.01 Kw/m<sup>3</sup> based on typical power requirements ranging between 0.008 and 0.013 kW/m<sup>3</sup> (Tchobanoglus et al., 2003). Energy consumption for several different aeration rates in the investigated IFAS were taken from previous work (Singh et al., 2017), and a line of regression calculated to predict the consumption at intermediate DO concentrations (see Fig. S1 of the supplementary material). The components of the IFAS system that were common across configurations were not included to improve resolution of the analysis.

Once the inventory was compiled, the relative impact scores for each measure could be generated by way of the IMPACT 2002+ method using Simapro Analyst 9.3.0.2 LCA software coupled with the Ecoinvent 3.8 database (Jolliet et al., 2003). This method was chosen being a comprehensive alternative and due to its capacity to produce a single environmental score that was necessary to the present work.

## 2.6. Economic assessment

To consider the economics of each measure, the relative costs were calculated for each of the measures of the inventory per  $1\text{ m}^3$  treated wastewater at present value. Costs were considered in an Indian context due to India being the country of focus in earlier trials (Singh et al., 2015, 2016, 2017). Costs were calculated at present value and did not consider future price fluctuations or variation due to inflation or interest rates. As such, the life cycle costs were simply calculated according to Equation (1):

$$\text{Life cycle cost, LCC } (\$/\text{m}^3) = C_c + C_o \quad (1)$$

Where  $C_c$  represents capital costs ( $\$/\text{m}^3$ ) such as anoxic tank and mixer costs, while  $C_o$  represents operational costs ( $\$/\text{m}^3$ ) such as energy for aeration and agitation. Energy costs in India were taken as  $\$0.077/\text{kWh}$  according to current databases (Global petrol prices, 2022), while the cost of stainless steel in tank construction was taken as  $\$3.28/\text{kg}$  according to Indian suppliers (Indiamart, 2022).

## 2.7. Sustainability assessment

Recent work has extended the widely used eco-efficiency index (EEI) that integrates environmental and economic costs into a single comparable index (Mocholi-Arce et al., 2020), to incorporate a third factor – technical performance of wastewater treatment (Pryce et al., 2022b). By doing so, the productivity of an investigated strategy or system is not compromised in sight of only greatest eco-efficiency. While a fourth factor (social) is sometimes used within sustainability indices to account for odours, noise, visual impact, public acceptance and complexity (Molinos-Senante et al., 2014), these were excluded from the present study being of little value in the configuration comparison. The tri-factor sustainability index (TFSI) scores are calculated as according to Equation (2) (Pryce et al., 2022b):

$$\text{TFSI} = \left[ \frac{EnS_n}{EnS_{max}} \right] \frac{1}{WI_n} + \left[ \frac{EcS_n}{EcS_{max}} \right] \frac{1}{WI_n} + \left[ \frac{PS_n}{PS_{max}} \right] \frac{1}{WI_n} \quad (2)$$

Where  $EnS_n$  = The environmental score of strategy  $n$ ,  $EnS_{MAX}$  is the highest environmental score of all the strategies,  $EcS_n$  is the economic score of strategy  $n$  and  $EcS_{MAX}$  is the highest environmental score for this indicator.  $PS_n$  is the overall performance score of strategy  $n$  and  $PS_{MAX}$  is the highest performance score achieved for this indicator. Finally,  $WI_n$  is the relative weighting given to each indicator  $n$ . For the present study, weighting was assigned as determined in a recent study that sought to rank each of the sustainability dimensions (Agarwal and Singh, 2022). As such the relative weightings were taken as 0.204, 0.299 and 0.56 for the environmental, economical and technical aspects respectively. While the index in that work also included a social aspect, this weighting (0.057) was divided equally between the remaining indicators.

In the present work the TFSI is comprised of LCIA and LCCA scores to represent environmental impact and economic costs, while the water pollution index (WPI) developed by Hossain and Patra (2020) is used to represent treatment performance. The WPI generates a water quality score capable of integrating multiple quality parameters relative to set limits (Hossain and Patra, 2020), however in the present work only TN is used being the focus of this study. The WPI is calculated as according to Equation (3) (Hossain and Patra, 2020):

$$\text{Water Pollution Index, WPI} = \frac{1}{n} \sum_{i=1}^n 1 + \left( \frac{C_i - S_i}{S_i} \right) \quad (3)$$

Where  $n$  is the number of parameters being integrated,  $C_i$  is the effluent concentration of the  $i_{th}$  parameter and  $S_i$  is the effluent limit for that parameter as designated by the CBCP in this case (MoEFCC, 2015). Further details of the TFSI can be found in recent work (Pryce et al., 2022b).

## 3. Results and discussion

### 3.1. Evaluating treatment performance in a single-stage configuration

Results of the investigation into maximizing TN removal by SND showed the lowest achievable effluent TN concentration to be  $8.7\text{ mg/L}$  at the optimum operational parameter settings of  $3.5\text{ mg/L}$  DO concentration and a relative RAS flow rate of 1.25Q. This conformed to Indian effluent limits for TN of  $<10\text{ mg/L}$  (MoEFCC, 2015). As indicated in Fig. 2a, the greatest TN removal was achievable when DO concentrations were above  $2\text{ mg/L}$ . These findings were succinct with earlier modelling work by Shaw et al. (2003), who investigated a three stage anoxic-IFAS-IFAS system. They observed high levels of SND in the two aerobic IFAS reactors that maintained respective DO concentrations of 3 and  $4\text{ mg/L}$ . Empirical work has also supported these findings. In a sequencing batch biofilm reactor (SBBR), Li et al. (2007) showed a DO concentration below  $4\text{ mg/L}$  to be preferable for SND, while Zhang et al. (2009) also reported the greatest SND to occur at a DO concentration between 3 and  $4\text{ mg/L}$ . Furthermore, the role of heterotrophic aerobic denitrifiers in providing SND in IFAS reactors is gaining increasing focus in recent years (Jia et al., 2020; Sriwiryarat et al., 2021), with 3–5  $\text{mg/L}$  being the recommended DO concentration to maximize its efficiency (Ji et al., 2015).

In terms of BOD removal, a positive relationship was observed with oxygen availability which was unsurprising being an oxidative process (Penn et al., 2009). Effluent BOD concentrations reduced more slowly above a DO concentration of  $3\text{ mg/L}$  as shown in Fig. 2b, suggesting this to be a critical level for organic matter removal in the IFAS system. While RAS rate was observed to offer little influence to BOD removal, some influence was observed between 1.5 and  $2.5\text{ mg/L}$  with performance seen to improve at higher rates. This is likely to be a reflection of the increasing carbon uptake for denitrification as  $\text{NO}_3$  is being produced (Raper et al., 2019). At higher DO concentrations, less anoxic environments will be present as oxygen penetrates further into the colonies which will constrain further denitrification (Satoh et al., 2003; Daigger et al., 2007). With TSS demonstrating a similar effluent profile to BOD in Fig. 2c, it can be concluded that neither BOD or TSS effluent limits would be compromised at the optimum aeration and recycle rates identified for maximum TN removal.

In terms of the RAS rate, Fig. 2a shows only little influence on TN removal across the whole profile providing a sufficient rate is met. This is shown more clearly in Fig. 3, where by a minimum rate of 0.9Q (90% of influent flow rate) is required to achieve the target effluent limits, while a minimum of 1.125Q appears to incur less variability in TN removal. Previous work by Mu'azu et al. (2020) also found TN removal to be only mildly influenced by increasing RAS rate, particularly at higher DO concentrations ( $\sim 5\text{ mg/L}$ ). IFAS systems are expected to be less affected by RAS rate than AS systems, with the majority of TN removal known to incur in the attached colonies (Regmi et al., 2011; Moretti et al., 2015; Phanwilai et al., 2020). What the model has shown is that it is possible to achieve both improved performance and cost-efficiency gains by reducing the RAS pump rate from the initial rate of 1.6–1.75Q employed in earlier work (Singh et al., 2015).

### 3.2. Evaluating treatment performance in a two-stage configuration

Investigation of incorporating an anoxic tank into the configuration to facilitate subsequent denitrification in contrast to SND revealed greater TN removal was achievable in a two-stage configuration. The results showed that TN removal could be maximized to achieve a minimum effluent concentration of  $4.2\text{ mg/L}$ . However, realizing this level of TN removal required the greatest oxygen availability in the aerobic reactor and longest retention time in the anoxic zone. This would be expected with a DO concentration of  $4.5\text{ mg/L}$  yielding the greatest level of nitrification and therefore the most  $\text{NO}_3$  being delivered to the denitrification phase (Sriwiryarat et al., 2008). As Fig. 4a shows, TN

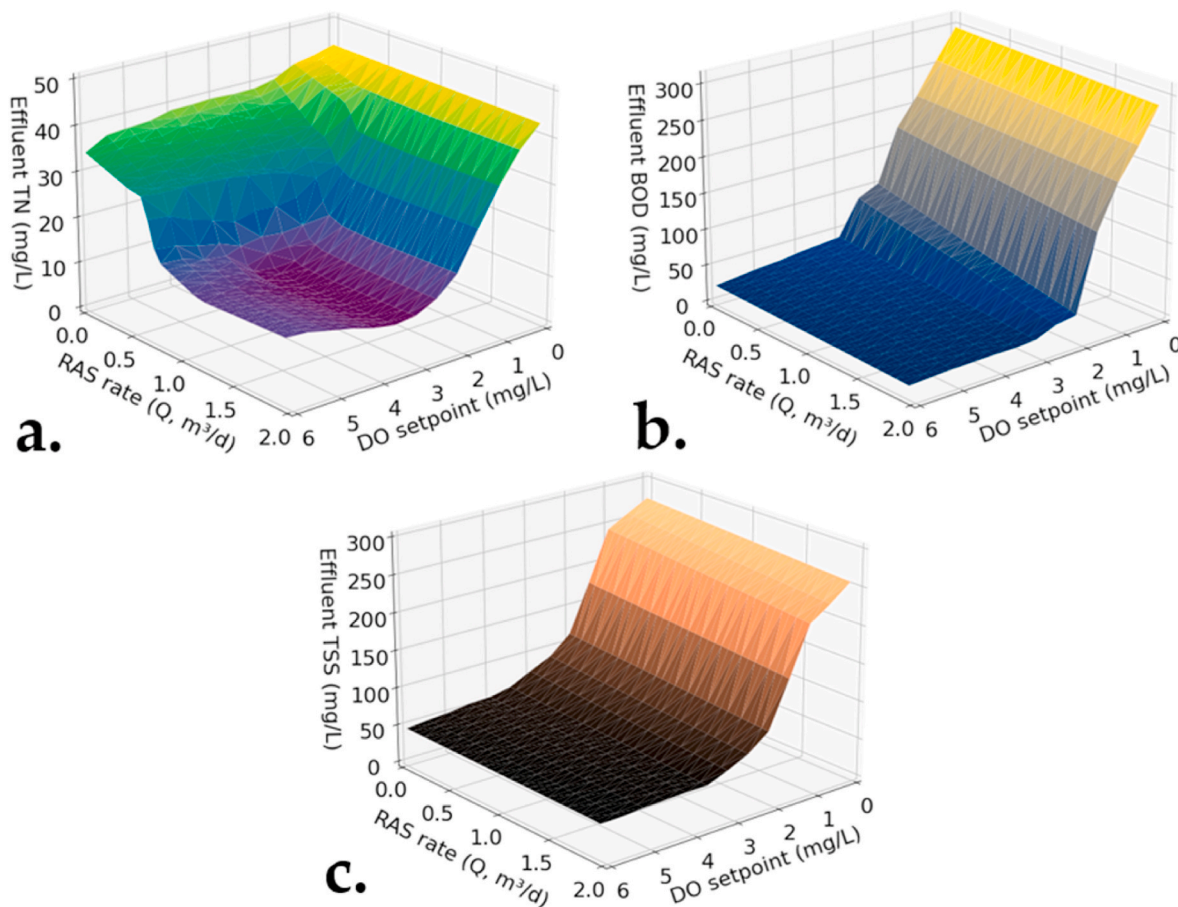

Fig. 2. Influence of operational parameter settings (DO setpoint and RAS rate) on effluent parameters in the IFAS including a. effluent TN, b. effluent BOD, c. effluent TSS. Darker shades indicate lower effluent concentration of pollutant.

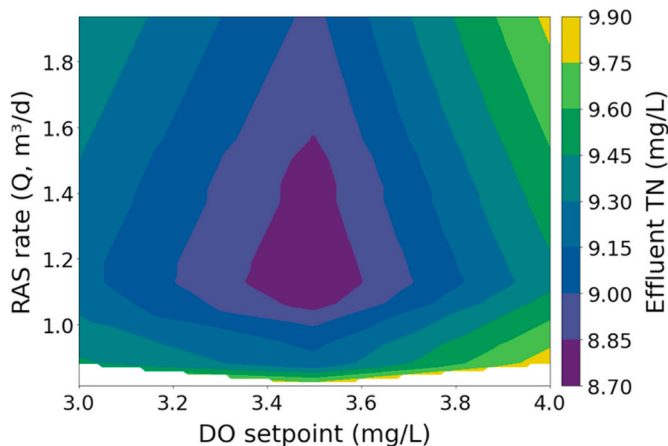

Fig. 3. TN profile of the single-stage system under alternative operational settings (RAS rate and DO setpoint). Only model outputs are displayed when investigated effluent parameters (TN, BOD and TSS) do not exceed proposed Indian effluent limits (MoEFCC, 2015), i.e. TN < 10 mg/L, BOD < 30 mg/L, TSS < 100 mg/L.

removal performance largely reflected oxygen availability, however at the higher DO setpoints the anoxic volume was found to be more influential. Intuitively, the effluent TN concentration was starting to increase in the absence of an anoxic tank at higher DO levels, likely due to limited facility of denitrification coupled with rising NO<sub>3</sub> production. In contrast, when denitrification was facilitated by an anoxic zone,

effluent TN was substantially reduced.

The removal of organics and TSS was primarily governed by the set DO concentration with anoxic volume having little effect as shown in Fig. 4b and c respectively. Providing a DO concentration of at least 2 mg/L was available, sufficient settling was observed which was beneficial for the removal performance of both parameters. This supports previous work that identified 2 mg/L to be a minimum for good settling in an AS system (Wilén and Balmer, 1999), and suggests the integration of media has little effect on the oxygen requirement for adequate settling. Furthermore, above this concentration the inclusion of an anoxic tank at any volume was not seen to compromise their removal. This was succinct with previous work that found a post-anoxic phase to have limited influence on sludge settling properties (Alagha et al., 2020).

When the TN profile was visualised in greater focus, it was observed a minimum DO concentration of 3 mg/L was required to ensure Indian standards of each investigated pollutant were met. Fig. 5 shows that in the absence of a dedicated anoxic zone, only the highest DO setpoints would not achieve the effluent targets in this range. The influence of increasing anoxic volume is shown to be mostly gradual between DO concentrations of 3–4.5 mg/L with the exception of the lower volumes at the highest setpoint. In this case it is clear that even the addition of only a small anoxic tank of <5 m<sup>3</sup> will yield substantial performance gains, provoking further investigation into the minimum effective volume in light of land limitations.

Investigation at the highest DO setpoint revealed an anoxic tank volume of only 1 m<sup>3</sup> would be required to achieve the effluent TN limit (<10 mg/L), however this was recognised as a lower performance than the single-stage system at its optimum operational settings (8.7 mg/L).

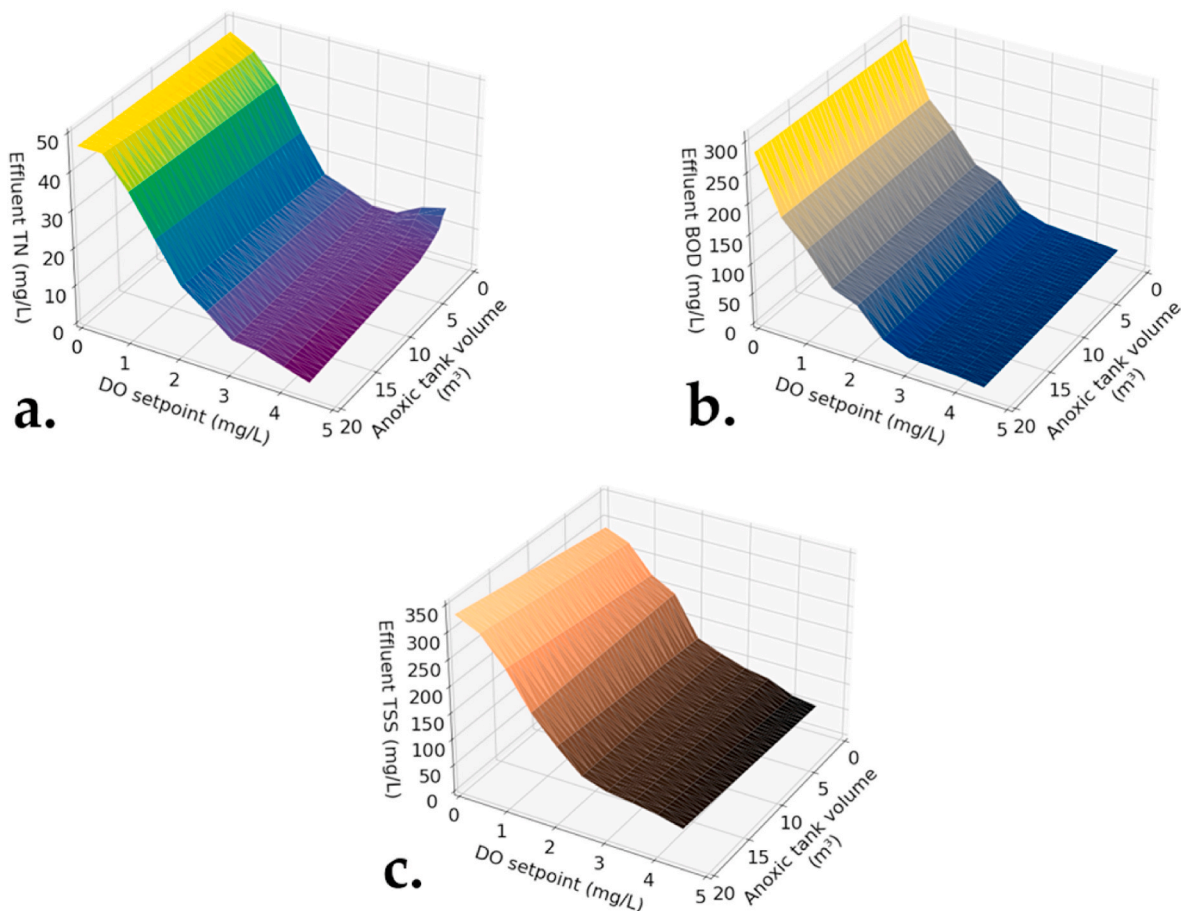

Fig. 4. Influence of design and operational values (anoxic tank volume and DO setpoint) on effluent parameters in the IFAS system including a. effluent TN, b. effluent BOD, c. effluent TSS. Darker shades indicate lower effluent concentration of pollutant.

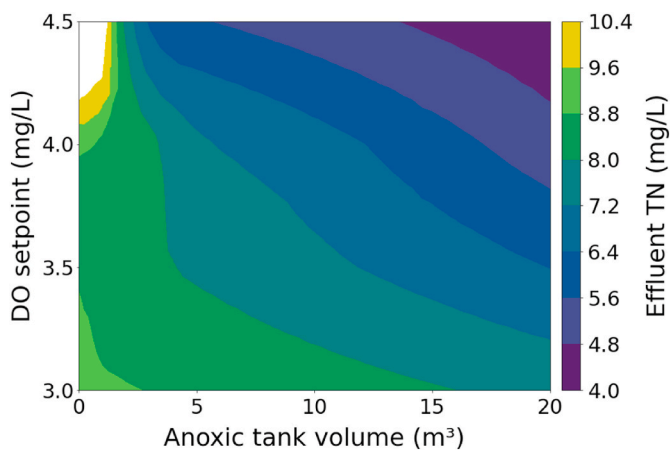

Fig. 5. TN profile of the single-stage system under alternative design and operational settings (anoxic tank volume/HRT and DO setpoint). Only model outputs are displayed when investigated effluent parameters (TN, BOD and TSS) do not exceed proposed Indian effluent limits, i.e. TN < 10 mg/L, BOD < 30 mg/L, TSS < 100 mg/L.

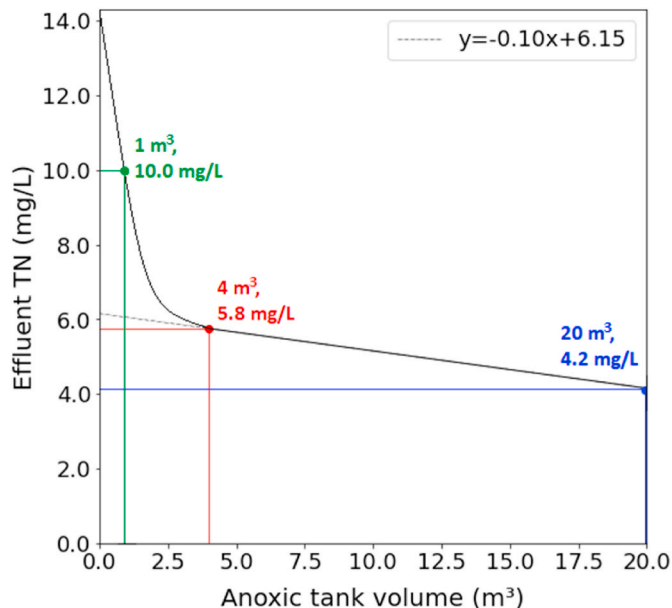

Fig. 6. Influence of anoxic tank volume on effluent TN at the highest investigated DO concentration (4.5 mg/L). Effluent concentrations are highlighted at 4 m<sup>3</sup> and 20 m<sup>3</sup> volume.

More interestingly, TN removal was seen to increase disproportionately with increasing anoxic tank volume until 4 m<sup>3</sup> as shown in Fig. 6. This would be expected at this higher DO concentration (4.5 mg/L) where SND is prevented in the aerobic tank due to deeper oxygen penetration in the bacterial colonies (Cao et al., 2017; Bhattacharya and Mazumder, 2021). As a result, an accumulation of NO<sub>3</sub> is expected at the start of the

anoxic phase (Sriwiriyarat et al., 2008). The results in Fig. 6 suggest that under the described conditions, the majority of denitrification activity is therefore occurring within the first 4 m<sup>3</sup> where the readily available supply of NO<sub>3</sub> is coupled with the required electrons from the remaining influent carbon (Raper et al., 2019). This would explain why only gradual improvement in TN removal of 0.1 mg/L per 0.5 m<sup>3</sup> volume is observed above 4 m<sup>3</sup>, being due to a limiting supply of NO<sub>3</sub> or organic carbon. In fact, while a 4 m<sup>3</sup> anoxic tank would yield an effluent TN concentration of 5.8 mg/L, increasing the volume to 20 m<sup>3</sup> would return only a further 1.6 mg/L improvement.

While the 20 m<sup>3</sup> anoxic configuration will yield the lowest effluent TN concentration overall, there is strong reason for the 4 m<sup>3</sup> alternative to be favoured in development. For example, a key market for this technology is the developers of large residential and tourist complexes above a certain size that require decentralized onsite treatment to be provided as mandated since 2004 (Kuttuva et al., 2018). In this market, decision-making is likely to be guided by a combination of site limitations, maximizing profits and legal obligation (Bhullar, 2013). As is common in built-up urban centres, these developments leave little available space surrounding the building in order to maximize the profit margin of the development through increased height. What little space remains will be carefully allocated, and options that minimize the footprint required for services are likely to be favoured, both by the developers and the residents (Gu et al., 2016). Secondly, while developers are mandated to provide onsite treatment, they are unlikely to spend more than required for better treatment if they can still avoid any legal repercussions with a more cost-effective alternative. This is worsened by the poor enforcement of onsite and regional effluent targets being achieved (Kuttuva et al., 2018; Reymond et al., 2020; Breitenmoser et al., 2022).

### 3.3. Evaluating economic and environmental costs of each configuration

Comparison between the key configuration scenarios detailed in Table 2 revealed the additional environmental and economic costs that would be incurred to realise the enhanced TN removal. Fig. 7 shows that in single-stage configuration when only SND is relied upon for TN removal, a cost of \$0.14/m<sup>3</sup> is incurred to meet aeration demand with an impact score of 1.02 Pt/m<sup>3</sup>. The costs of achieving a further effluent TN reduction of 2.9 mg/L as in Scenario 2, are \$0.02/m<sup>3</sup> and 0.11 Pt/m<sup>3</sup> to meet the greater aeration rate, the provision of agitation and additional construction. Reducing the effluent concentration by a further 1.6 mg/L as in Scenario 3 would incur a further \$0.01/m<sup>3</sup> cost (\$0.03/m<sup>3</sup> total) but only a marginal increase in environmental burden (<0.0001 Pt/m<sup>3</sup>). Furthermore, due to the reduced oxygen demand and lack of need for anoxic agitation, Scenario 1 is found to offer energy savings of 9.4% when compared to alternative scenarios.

Consideration for the respective costs at the construction and operation life stages demonstrates significant disparity between single- and two-stage configurations, although only marginal difference between Scenarios 2 and 3. More prominent is the asymmetry between these life stages attributed to the high energy consumption incurred by aeration (Martins et al., 2019). Increasing the TN removal capacity by 2.9 mg/L (4 m<sup>3</sup> anoxic tank) and 4.5 mg/L (20 m<sup>3</sup> anoxic tank) would incur an additional capital outlay of \$1648 and \$4686 respectively. In comparison, a total expenditure of \$38,614 will be required to supply the

**Table 2**

Design and operational configurations under different scenarios displayed with relative operational energy demand.

Scenario	DO setpoint (mg/L)	Anoxic volume (m <sup>3</sup> )	Energy demand (kWh/m <sup>3</sup> )
1	3.5	0	1.83
2	4.5	4	2.01
3	4.5	20	2.01

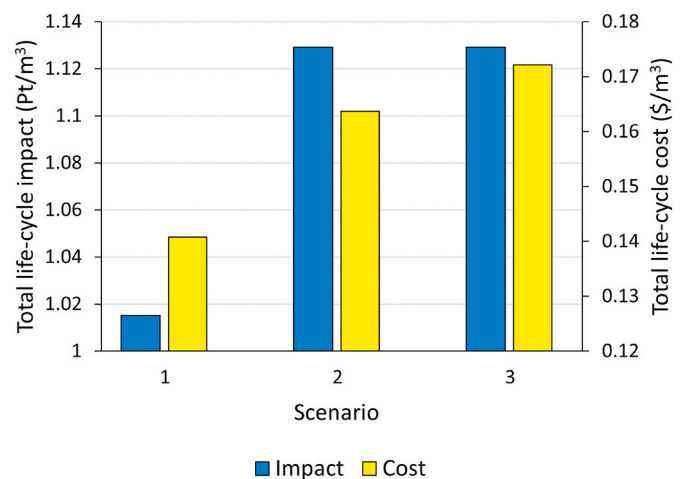

**Fig. 7.** Environmental and economic total life-cycle performance (i.e. construction and operation) of three configuration scenarios as described in Table 2.

additional 1 mg/L of DO at current prices over the 15-year service life. Relative disparity is also observed in terms of environmental impact between these stages with the 4 m<sup>3</sup> and 20 m<sup>3</sup> incurring respective scores of 1.58 Pt and 4.51 Pt during construction but an additional 256, 710 Pt during total operation.

While the two-stage configurations provoke considerable additional expenditure in comparison to the single-stage system, the reduction in TN being released into the environment will have its own economic value that may offset costs, although difficult to quantify due to having no direct market value (Molinos-Senante et al., 2010). Such value may come from the potential for water reuse (Hagen et al., 2017), willingness-to-pay (Paola et al., 2018), avoided environmental costs (Hernández-Sancho et al., 2010; Molinos-Senante et al., 2013), resource-recovery (Foglia et al., 2021) or even the preservation of ecosystem services (Marre et al., 2015). There is therefore good cause for maximum TN removal to be prioritized that could see justification for the additional costs of the most expensive and impacting configuration.

Conversely, with the increasing prevalence of energy poverty (Li et al., 2021), the current climate may favour the most energy-efficient solution. Energy prices are rising at unprecedented rates due to geopolitical instability (Nezhyva and Mysiuk, 2022), renewable uptake (Curley et al., 2022), increasing expense of fossil-fuel extraction (Kreps, 2020), and rising inflation (Modi, 2022) amongst other reasons. Energy-efficiency has long been growing as a priority in technology development (Mahi et al., 2021), yet its value as a positive influence on human health is now also gaining attention (Zhong et al., 2022). Energy consumption is a key driver of environmental impact (Martins et al., 2019), while aeration accounts for between 50 and 90% of the energy consumption in a biological WWTP (Drewnowski et al., 2019). Its reduction will yield green benefits that are becoming increasingly attractive in the product market (Hashem, 2021). However, in the face of severe energy price hikes, it is the economic benefits that will show the greatest return and money is often the language that talks the loudest in development (Di Foggia, 2018; He and Chen, 2021; Ullah et al., 2021).

### 3.4. Evaluating the sustainability of each configuration

Despite Scenario 3 incurring significantly higher environmental and economic costs compared to the energy-efficient SND configuration, Fig. 8 indicates this to be the more sustainable alternative overall when the TN treatment performance is incorporated. In terms of the TFSI, Scenario 3 demonstrated the greatest sustainability with a lower score of 0.77 Pt/m<sup>3</sup>. Respectively, Scenario 2 scored 0.86 Pt/m<sup>3</sup> while Scenario 1



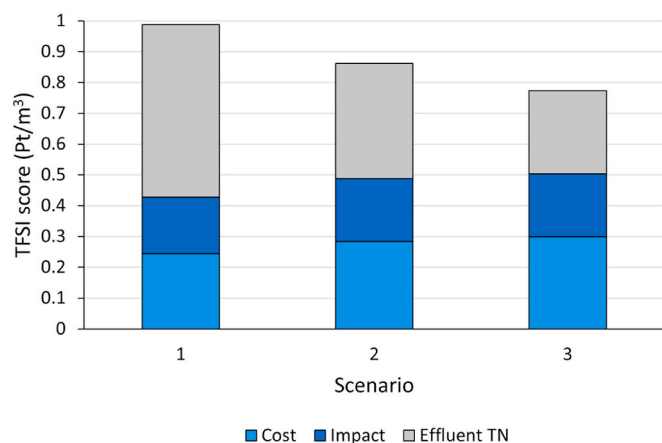

**Fig. 8.** TFSI scores and component inputs of each of the three configuration scenarios as described in Table 2. Lower score indicates greater overall sustainability.

was in fact shown to be the least sustainable option scoring 0.99 Pt/m<sup>3</sup>. These results suggest that the environmental and economic efficiency gains that Scenario 1 affords do not provoke greater sustainability. In contrast, the higher environmental and economic costs incurred by the two-stage scenarios are offset by the greater environmental sensitivity of the cleaner effluent. This is intuitive with Scenario 3 shown to remove an extra 4.5 mg/L TN compared to Scenario 1, which amounts to a substantial 1.72 tonnes less TN being introduced to the environment over the service life.

With TN removal performance being central to the sustainability of each configuration, sustainability may shift under different influent compositions. For example, the C:N ratio is known to be critical to TN removal performance (Bueno et al., 2018). In the current model, this ratio is relatively high at 9.3 (Bueno et al., 2018). While a higher C:N ratio is beneficial for both TN removal strategies (Bueno et al., 2018; Phanwilai et al., 2020), a lower C:N ratio has been shown to be less detrimental to the SND strategy (Chai et al., 2019). This would be expected due to the limited carbon supply being available when the denitrifying activity is occurring. In contrast, a low C:N ratio should be more detrimental to the two-stage process with the denitrifying activities occurring after the carbon source is reduced during the proceeding oxidation phase. Intuitively, this suggests a shift in the relative TN removal performance of the two strategies that may then favour the single-stage strategy when the environmental and economic gains are also considered. However, such an investigation will also need to weigh the environmental and economic costs of providing an external carbon source to the anoxic zone in the two-stage configuration as a further scenario. By doing so, TN removal performance would be expected to improve significantly in the two-stage system (Zou et al., 2022), that may again outweigh the additional costs incurred.

Further scenarios for investigation are also considered, relating to partial nitrification for shortcut nitrification/denitrification (Peng and Zhu, 2006). The benefits of this TN removal pathway have been theorized as energy savings up to 60% for aeration due to lower oxygen demand in the aerobic stage, up to 40% less electron donor requirement in anoxic stage, up to 2 x faster denitrification of nitrite (NO<sub>2</sub>) than NO<sub>3</sub>, lower sludge production in both stages and up to 20% less CO<sub>2</sub> emission (Peng and Zhu, 2006). This pathway is achievable in both the single-stage (Peng et al., 2020) and two-stage designs (Peng and Zhu, 2006), providing the operational parameters are correctly configured. Iannacone et al. (2021) suggested these settings to include a short sludge retention time (SRT) of <5 days, DO concentration between 1 and 2 mg/L, temperature >25 °C and as well the use of intermittent aeration (IA). However, nitrite oxide (N<sub>2</sub>O) emissions will also need to be measured and stipulated in the environmental assessment, having been

reported to be considerably increased during this pathway (Peng et al., 2020).

#### 4. Conclusion

In the present work, the sustainability of three alternative configurations of a packaged IFAS system have been evaluated and compared by use of a recently-developed tri-factor sustainability index (technical, environmental, economical). The optimum configurations for maximum TN removal were first identified in terms of design and operational parameters by way of process modelling. TN removal performance for each configuration was then assessed. The environmental and economic costs of each configuration were assessed by way of LCIA and LCCA respectively.

These findings have identified the packaged IFAS system to be most sustainable when in a two-stage configuration with an additional anoxic tank at equal volume to the aerobic tank (1:1 aerobic-anoxic ratio) and a DO concentration maintained at 4.5 mg/L. This is due to the greater performance of TN removal that was shown to outweigh the additional environmental and economic costs incurred when compared to the single-stage configuration. Furthermore, the two-stage configuration remained the most sustainable alternative even when the anoxic tank was reduced to 1/5th the volume of the aerobic tank (5:1 aerobic-anoxic ratio).

In terms of performance, the results showed that the packaged IFAS system was able to achieve Indian effluent TN limits of <10 mg/L in both the single- and two-stage configurations without compromising the removal of other key pollutants. As a single-stage system, the operational settings to maximize TN removal have been identified as a DO setpoint of 3.5 mg/L and a sludge recycle rate of 87 m<sup>3</sup>/d or 125% of the influent flow rate. Under this configuration, the system has demonstrated an effluent TN concentration of 8.7 mg/L. As a two-stage configuration, an effluent concentration of 4.2 mg/L was shown to be achievable under the highest DO setpoint (4.5 mg/L) and with an equal anoxic volume, but 5.8 mg/L when the smaller anoxic zone is provided.

Operating the system as a two-stage configuration was shown to incur an additional \$38,614 for the higher aeration and anoxic agitation compared to the single-stage configuration with further capital costs of \$1648 and \$4686 for the 4 m<sup>3</sup> and 20 m<sup>3</sup> anoxic tanks respectively. With regards to environmental impact, the two-stage configurations provoked an additional impact of 256,710 Pt during operation and 1.58 Pt and 4.51 Pt during construction for the small and large anoxic tanks respectively.

It is hoped that these findings will provide a better understanding of the IFAS system's robust capabilities and relative sustainability to better inform decision-making during optioneering of suitable solutions for nitrogen removal in an urban environment. In this way, water security and environmental health may be better preserved in the face of continued urbanization. Further work should now seek to compare the sustainability of these configurations under different influent loads, as well as including configurations that target alternative TN removal pathways such as partial nitrification.

#### CRedit authorship contribution statement

**David Pryce:** Conceptualization, Methodology, Data curation, Investigation, Writing – original draft. **Zoran Kapelan:** Visualization, Validation, Supervision. **Fayyaz A. Memon:** Visualization, Validation, Supervision.

#### Declaration of competing interest

The authors declare that they have no known competing financial interests or personal relationships that could have appeared to influence the work reported in this paper.

## Data availability

No data was used for the research described in the article.

## Acknowledgements

This work was funded by the Engineering and Physical Sciences Research Council (EPSRC) under the STREAM Centre for Doctoral Training programme (EP/L015412/1).

## Appendix A. Supplementary data

Supplementary data to this article can be found online at <https://doi.org/10.1016/j.jclepro.2022.135619>.

## References

- Agarwal, S., Singh, A.P., 2022. Performance evaluation of textile wastewater treatment techniques using sustainability index: an integrated fuzzy approach of assessment. *J. Clean. Prod.* 337, 130384 <https://doi.org/10.1016/j.jclepro.2022.130384>.
- Akhoundi, A., Nazif, S., 2018. Sustainability assessment of wastewater reuse alternatives using the evidential reasoning approach. *J. Clean. Prod.* 195, 1350–1376. <https://doi.org/10.1016/j.jclepro.2018.05.220>.
- Alagha, O., Allazem, A., Bukhari, A.A., Anil, I., Mu'azu, N.D., 2020. Suitability of SBR for wastewater treatment and reuse: pilot-scale reactor operated in different anoxic conditions. *Int. J. Environ. Res. Publ. Health* 17 (5), 1617. <https://doi.org/10.3390/ijerph17051617>.
- Bhatia, A., Singh, N.K., Bhandu, T., Pathania, R., Kazmi, A.A., 2017. Effect of intermittent aeration on microbial diversity in an intermittently aerated IFAS reactor treating municipal wastewater: a field study. *J. Environ. Sci. Health, Part A* 52 (5), 440–448. <https://doi.org/10.1080/10934529.2016.1271665>.
- Bhattacharya, R., Mazumder, D., 2021. Simultaneous nitrification and denitrification in moving bed bioreactor and other biological systems. *Bioproc. Biosyst. Eng.* 44 (4), 635–652. <https://doi.org/10.1007/s00449-020-02475-6>.
- Bhullar, L., 2013. Ensuring safe municipal wastewater disposal in urban India: is there a legal basis? *J. Environ. Law* 25 (2), 235–260. <https://doi.org/10.1093/jel/eqt004>.
- Breitenmoser, L., Quesada, G.C., Anshuman, N., Bassi, N., Dkhar, N.B., Phukan, M., Hooijmans, C.M., 2022. Perceived drivers and barriers in the governance of wastewater treatment and reuse in India: insights from a two-round Delphi study. *Resour. Conserv. Recycl.* 182, 106285 <https://doi.org/10.1016/j.resconrec.2022.106285>.
- Bueno, R.F., Piveli, R.P., Campos, F., Sobrinho, P.A., 2018. Simultaneous nitrification and denitrification in the activated sludge systems of continuous flow. *Environ. Technol.* 39 (20), 2641–2652. <https://doi.org/10.1080/09593330.2017.1363820>.
- Cao, Y., Zhang, C., Rong, H., Zheng, G., Zhao, L., 2017. The effect of dissolved oxygen concentration (DO) on oxygen diffusion and bacterial community structure in moving bed sequencing batch reactor (MBSBR). *Water Res.* 108, 86–94. <https://doi.org/10.1016/j.watres.2016.10.063>.
- Chai, H., Xiang, Y., Chen, R., Shao, Z., Gu, L., Li, L., He, Q., 2019. Enhanced simultaneous nitrification and denitrification in treating low carbon-to-nitrogen ratio wastewater: treatment performance and nitrogen removal pathway. *Bioresour. Technol.* 280, 51–58. <https://doi.org/10.1016/j.biortech.2019.02.022>.
- Crabtree, H.E., 1983. Some observations on denitrification in activated sludge final settlement tanks. *Water Pollut. Control* 82 (3), 315–325.
- Curley, M., Kaul, U., Orr, S.K., Vine, D., 2022. Greenflation: are commodity prices actually rising? *Env't L. Rep.* 52, 10345.
- Daigger, G.T., Adams, C.D., Steller, H.K., 2007. Diffusion of oxygen through activated sludge flocs: experimental measurement, modelling, and implications for simultaneous nitrification and denitrification. *Water Environ. Res.* 79 (4), 375–387. <https://doi.org/10.2175/106143006X111835>.
- Delanka-Pedige, H.M.K., Munasinghe-Arachchige, S.P., Abeyisiriwardana-Arachchige, I.S.A., Nirmalakhandan, N., 2021. Evaluating wastewater treatment infrastructure systems based on UN Sustainable Development Goals and targets. *J. Clean. Prod.* 298, 126795 <https://doi.org/10.1016/j.jclepro.2021.126795>.
- Di Foggia, G., 2018. Energy efficiency measures in buildings for achieving sustainable development goals. *Heliyon* 4 (11), e00953. <https://doi.org/10.1016/j.heliyon.2018.e00953>.
- Drownowski, J., Remiszewska-Skwarek, A., Duda, S., Łagód, G., 2019. Aeration process in bioreactors as the main energy consumer in a wastewater treatment plant. Review of solutions and methods of process optimization. *SAVE Proc.* 7 (5), 311. <https://doi.org/10.3390/pr7050311>.
- Farazaki, M., Gikas, P., 2019. Nitrification-denitrification of municipal wastewater without recirculation, using encapsulated microorganisms. *J. Environ. Manag.* 242, 258–265. <https://doi.org/10.1016/j.jenvman.2019.04.054>.
- Foglia, A., Bruni, C., Cipolletta, G., Euseibi, A.L., Frison, N., Katsou, E., Fatone, F., 2021. Assessing socio-economic value of innovative materials recovery solutions validated in existing wastewater treatment plants. *J. Clean. Prod.* 322, 129048 <https://doi.org/10.1016/j.jclepro.2021.129048>.
- Global petrol prices, 2022. [https://www.globalpetrolprices.com/electricity\\_prices/](https://www.globalpetrolprices.com/electricity_prices/). Accessed 17/05/22.
- Gu, B., Fan, L., Ying, Z., Xu, Q., Luo, W., Ge, Y., Chang, J., 2016. Socioeconomic constraints on the technological choices in rural sewage treatment. *Environ. Sci. Pollut. Res.* 23 (20), 20360–20367. <https://doi.org/10.1007/s11356-016-7267-z>.
- Hagen, B., Pijawka, D., Prakash, M., Sharma, S., 2017. Longitudinal analysis of ecosystem services' socioeconomic benefits: wastewater treatment projects in a desert city. *Ecosyst. Serv.* 23, 209–217. <https://doi.org/10.1016/j.ecoser.2016.12.014>.
- Hashem, T.N., 2021. Environmental legitimacy through adopting green products and its effect on the brand equity: moderating role of management awareness. *Res. World Econ.* 12 (2), 197–210. <https://doi.org/10.5430/rwe.v12n2p197>.
- He, L., Chen, L., 2021. The incentive effects of different government subsidy policies on green buildings. *Renew. Sustain. Energy Rev.* 135, 110123 <https://doi.org/10.1016/j.rser.2020.110123>.
- Henze, M., Dupont, R., Grau, P., De La Sota, A., 1993. Rising sludge in secondary settlers due to denitrification. *Water Res.* 27 (2), 231–236. [https://doi.org/10.1016/0043-1354\(93\)90080-2](https://doi.org/10.1016/0043-1354(93)90080-2).
- Hernández-Sancho, F., Molinos-Senante, M., Sala-Garrido, R., 2010. Economic valuation of environmental benefits from wastewater treatment processes: an empirical approach for Spain. *Sci. Total Environ.* 408 (4), 953–957. <https://doi.org/10.1016/j.scitotenv.2009.10.028>.
- Holmes, D.E., Dang, Y., Smith, J.A., 2019. Nitrogen cycling during wastewater treatment. *Adv. Appl. Microbiol.* 106, 113–192. <https://doi.org/10.1016/bs.aams.2018.10.003>.
- Hossain, M., Patra, P.K., 2020. Water pollution index—A new integrated approach to rank water quality. *Ecol. Indic.* 117, 106668 <https://doi.org/10.1016/j.ecolind.2020.106668>.
- Hydromantis, 2022. *Hydromantis Environmental Software Solutions. inc.*
- Iannacone, F., Di Capua, F., Granata, F., Gargano, R., Esposito, G., 2021. Shortcut nitrification-denitrification and biological phosphorus removal in acetate-and ethanol-fed moving bed biofilm reactors under microaerobic/aerobic conditions. *Bioresour. Technol.* 330, 124958 <https://doi.org/10.1016/j.biortech.2021.124958>.
- Indiamart, 2022. <https://dir.indiamart.com/impcat/stainless-steel.html>. Accessed 18/05/22.
- Ji, B., Yang, K., Zhu, L., Jiang, Y., Wang, H., Zhou, J., Zhang, H., 2015. Aerobic denitrification: a review of important advances of the last 30 years. *Biotechnol. Bioproc. Eng.* 20 (4), 643–651. <https://doi.org/10.1007/s12257-015-0009-0>.
- Jia, Y., Zhou, M., Chen, Y., Hu, Y., Luo, J., 2020. Insight into short-cut of simultaneous nitrification and denitrification process in moving bed biofilm reactor: effects of carbon to nitrogen ratio. *Chem. Eng. J.* 400, 125905 <https://doi.org/10.1016/j.cej.2020.125905>.
- Jolliet, O., Margni, M., Charles, R., Humbert, S., Payet, J., Rebitzer, G., Rosenbaum, R., 2003. Impact 2002+: a new life cycle impact assessment methodology. *Int. J. Life Cycle Assess.* 8, 324–330. <https://doi.org/10.1007/bf02978505>.
- Kreps, B.H., 2020. The rising costs of fossil-fuel extraction: an energy crisis that will not go away. *Am. J. Econ. Sociol.* 79 (3), 695–717. <https://doi.org/10.1111/ajes.12336>.
- Kuttuva, P., Lele, S., Mendez, G.V., 2018. Decentralized wastewater systems in Bengaluru, India: success or failure? *Wat. Econ. Pol.* 4 (2), 1650043 <https://doi.org/10.1142/S2382624X16500430>.
- Li, J., Peng, Y., Gu, G., Wei, S., 2007. Factors affecting simultaneous nitrification and denitrification in an SBBR treating domestic wastewater. *Front. Environ. Sci. Eng. China* 1 (2), 246–250. <https://doi.org/10.1007/s11783-007-0042-0>.
- Li, W., Chien, F., Hsu, C.C., Zhang, Y., Nawaz, M.A., Iqbal, S., Mohsin, M., 2021. Nexus between energy poverty and energy efficiency: estimating the long-run dynamics. *Res. Pol.* 72, 102063 <https://doi.org/10.1016/j.resourpol.2021.102063>.
- Lin, Y., Guo, M., Shah, N., Stuckey, D.C., 2016. Economic and environmental evaluation of nitrogen removal and recovery methods from wastewater. *Bioresour. Technol.* 215, 227–238. <https://doi.org/10.1016/j.biortech.2016.03.064>.
- Mahi, M., Ismail, I., Phoong, S.W., Isa, C.R., 2021. Mapping trends and knowledge structure of energy efficiency research: what we know and where we are going. *Environ. Sci. Pollut. Res.* 28 (27), 35327–35345. <https://doi.org/10.1007/s11356-021-14367-7>.
- Marre, J.B., Brander, L., Thebaud, O., Boncoeur, J., Pascoe, S., Cogan, L., Pascal, N., 2015. Non-market use and non-use values for preserving ecosystem services over time: a choice experiment application to coral reef ecosystems in New Caledonia. *Ocean Coast Manag.* 105, 1–14. <https://doi.org/10.1016/j.ocecoaman.2014.12.010>.
- Martins, F., Felgueiras, C., Smitkova, M., Caetano, N., 2019. Analysis of fossil fuel energy consumption and environmental impacts in European countries. *Energy* 12 (6), 964. <https://doi.org/10.3390/en12060964>.
- Mena-Ulcia, K., Hernández, H.H., 2015. Decentralized peri-urban wastewater treatment technologies assessment integrating sustainability indicators. *Water Sci. Technol.* 72 (2), 214–222. <https://doi.org/10.2166/wst.2015.209>.
- Mocholi-Arce, M., Gómez, T., Molinos-Senante, M., Sala-Garrido, R., Caballero, R., 2020. Evaluating the eco-efficiency of wastewater treatment plants: comparison of optimistic and pessimistic approaches. *Sustainability* 12 (24), 10580. <https://doi.org/10.3390/su122410580>.
- Modi, N., 2022. Rising costs spell disaster for the nation's health. *BMJ* 377. <https://doi.org/10.1136/bmj.o938>.
- MoEFCC, 2015. *Standards for Sewage Treatment Plants along with Time Frame for Implementation, Draft Notification. Government of India, New Delhi.*
- Molinos-Senante, M., Gómez, T., Garrido-Baserba, M., Caballero, R., Sala-Garrido, R., 2014. Assessing the sustainability of small wastewater treatment systems: a composite indicator approach. *Sci. Total Environ.* 497, 607–617. <https://doi.org/10.1016/j.scitotenv.2014.08.026>.
- Molinos-Senante, M., Hernández-Sancho, F., Sala-Garrido, R., 2010. Economic feasibility study for wastewater treatment: a cost-benefit analysis. *Sci. Total Environ.* 408 (20), 4396–4402. <https://doi.org/10.1016/j.scitotenv.2010.07.014>.

- Molinos-Senante, M., Hernández-Sancho, F., Sala-Garrido, R., Cirelli, G., 2013. Economic feasibility study for intensive and extensive wastewater treatment considering greenhouse gases emissions. *J. Environ. Manag.* 123, 98–104. <https://doi.org/10.1016/j.jenvman.2013.02.044>.
- Moretti, P., Choubert, J.M., Canler, J.P., Petrimaux, O., Buffière, P., Lessard, P., 2015. Understanding the contribution of biofilm in an integrated fixed-film-activated sludge system (IFAS) designed for nitrogen removal. *Water Sci. Technol.* 71 (10), 1500–1506. <https://doi.org/10.2166/wst.2015.127>.
- Mu'azu, N.D., Alagha, O., Anil, I., 2020. Systematic modeling of municipal wastewater activated sludge process and treatment plant capacity analysis using GPS-X. *Sustainability* 12 (19), 8182. <https://doi.org/10.3390/su12198182>.
- Nezhyya, M., Mysiuk, V., 2022. War in Ukraine: challenges for the global economy. *For. Trad. Econ. Fin. Law.* 121 (2), 16–25. [https://doi.org/10.31617/zt.knute.2022\(121\)02](https://doi.org/10.31617/zt.knute.2022(121)02).
- Paola, V., Mustafa, A.A., Giacomo, Z., 2018. Willingness to pay for recreational benefit evaluation in a wastewater reuse project. Analysis of a case study. *Water* 10 (7), 922. <https://doi.org/10.3390/w10070922>.
- Peng, B., Liang, H., Wang, S., Gao, D., 2020. Effects of DO on N<sub>2</sub>O emission during biological nitrogen removal using aerobic granular sludge via shortcut simultaneous nitrification and denitrification. *Environ. Technol.* 41 (2), 251–259. <https://doi.org/10.1080/09593330.2018.1494757>.
- Peng, Y., Zhu, G., 2006. Biological nitrogen removal with nitrification and denitrification via nitrite pathway. *Appl. Microbiol. Biotechnol.* 73 (1), 15–26. <https://doi.org/10.1007/s00253-006-0534-z>.
- Penn, M.R., Pauer, J.J., Mihelcic, J.R., 2009. Biochemical oxygen demand. *Env. Ecol. Chem.* 2, 278–297.
- Phanwilai, S., Kangwannarakul, N., Noophan, P.L., Kasahara, T., Terada, A., Munakata-Marr, J., Figueroa, L.A., 2020. Nitrogen removal efficiencies and microbial communities in full-scale IFAS and MBBR municipal wastewater treatment plants at high COD: N ratio. *Front. Environ. Sci. Eng.* 14 (6), 1–13. <https://doi.org/10.1007/s11783-020-1374-2>.
- Plakas, K.V., Georgiadis, A.A., Karabelas, A.J., 2016. Sustainability assessment of tertiary wastewater treatment technologies: a multi-criteria analysis. *Water Sci. Technol.* 73 (7), 1532–1540. <https://doi.org/10.2166/wst.2015.630>.
- Pryce, D., Kapelan, Z., Memon, F.A., 2022. A comparative evaluation of the sustainability of alternative aeration strategies in biological wastewater treatment to support net-zero future. *J. Clean. Prod.* 374, 134005 <https://doi.org/10.1016/j.jclepro.2022.134005>.
- Pryce, D., Kapelan, Z., Memon, F.A., 2022a. Modelling the performance of an integrated fixed-film activated sludge (IFAS) system: a systematic approach to automated calibration. *Sci. Rep.* 12 (1), 1–19. <https://doi.org/10.1038/s41598-022-13779-w>.
- Raper, E., Fisher, R., Anderson, D.R., Stephenson, T., Soares, A., 2019. Nitrogen removal from coke making wastewater through a pre-denitrification activated sludge process. *Sci. Total Environ.* 666, 31–38. <https://doi.org/10.1016/j.scitotenv.2019.02.196>.
- Regmi, P., Thomas, W., Schafran, G., Bott, C., Rutherford, B., Waltrip, D., 2011. Nitrogen removal assessment through nitrification rates and media biofilm accumulation in an IFAS process demonstration study. *Water Res.* 45 (20), 6699–6708. <https://doi.org/10.1016/j.watres.2011.10.009>.
- Reymond, P., Chandragiri, R., Ulrich, L., 2020. Governance arrangements for the scaling up of small-scale wastewater treatment and reuse systems—lessons from India. *Front. Environ. Sci.* 8, 72. <https://doi.org/10.3389/fenvs.2020.00072>.
- Rosso, D., Lothman, S.E., Jeung, M.K., Pitt, P., Gellner, W.J., Stone, A.L., Howard, D., 2011. Oxygen transfer and uptake, nutrient removal, and energy footprint of parallel full-scale IFAS and activated sludge processes. *Water Res.* 45 (18), 5987–5996. <https://doi.org/10.1016/j.watres.2011.08.060>.
- Satoh, H., Nakamura, Y., Ono, H., Okabe, S., 2003. Effect of oxygen concentration on nitrification and denitrification in single activated sludge flocs. *Biotechnol. Bioeng.* 83 (5), 604–607. <https://doi.org/10.1002/bit.10717>.
- Shaw, A.R., Johnson, T.L., Johnson, C., 2003. Intricacies of modelling the emerging integrated fixed-film activated sludge (IFAS) process. *Proc. Wat. Env. Fed.* 2003 (6), 95–107.
- Singh, N.K., Kazmi, A.A., Starkl, M., 2015. Environmental performance of an integrated fixed-film activated sludge (IFAS) reactor treating actual municipal wastewater during start-up phase. *Water Sci. Technol.* 72 (10), 1840–1850. <https://doi.org/10.2166/wst.2015.390>.
- Singh, N.K., Kazmi, A.A., Starkl, M., 2016. Treatment performance and microbial diversity under dissolved oxygen stress conditions: insights from a single stage IFAS reactor treating municipal wastewater. *J. Taiwan Inst. Chem. Eng.* 65, 197–203. <https://doi.org/10.1016/j.jtice.2016.05.002>.
- Singh, N.K., Singh, R.P., Kazmi, A.A., 2017. Environmental impact assessment of a package type IFAS reactor during construction and operational phases: a life cycle approach. *Water Sci. Technol.* 75 (10), 2246–2256. <https://doi.org/10.2166/wst.2017.110>.
- Sriwiriyarat, T., Jangkorn, S., Charoenpanich, J., Chinwetkitvanich, S., Fongsatitkul, P., 2021. Occurrence of aerobic denitrifying bacteria in integrated fixed film activated sludge system. *Chemosphere* 285, 131504. <https://doi.org/10.1016/j.chemosphere.2021.131504>.
- Sriwiriyarat, T., Ungkurarate, W., Fongsatitkul, P., Chinwetkitvanich, S., 2008. Effects of dissolved oxygen on biological nitrogen removal in integrated fixed film activated sludge (IFAS) wastewater treatment process. *J. Environ. Sci. Health, Part A* 43 (5), 518–527. <https://doi.org/10.1080/10934520701796481>.
- Sutton, M.A., Howard, C.M., Kanter, D.R., Lassaletta, L., Möring, A., Raghuram, N., Read, N., 2021. The nitrogen decade: mobilizing global action on nitrogen to 2030 and beyond. *One Earth* 4 (1), 10–14. <https://doi.org/10.1016/j.oneear.2020.12.016>.
- Tchobanoglus, G., Burton, F., Stensel, H.D., 2003. *Wastewater engineering: treatment and reuse*. Am. Water Works Assoc. J. 95 (5), 201.
- Ullah, R., Ahmad, H., Rehman, F.U., Fawad, A., 2021. Green innovation and Sustainable Development Goals in SMEs: the moderating role of government incentives. *J. Econ. Admin. Sci.* <https://doi.org/10.1108/JEAS-07-2021-0122>.
- Vlasopoulos, N., Memon, F.A., Butler, D., Murphy, R., 2006. Life cycle assessment of wastewater treatment technologies treating petroleum process waters. *Sci. Total Environ.* 367 (1), 58–70. <https://doi.org/10.1016/j.scitotenv.2006.03.007>.
- Wilén, B.M., Balmer, P., 1999. The effect of dissolved oxygen concentration on the structure, size and size distribution of activated sludge flocs. *Water Res.* 33 (2), 391–400. [https://doi.org/10.1016/S0043-1354\(98\)00208-5](https://doi.org/10.1016/S0043-1354(98)00208-5).
- Yu, C., Huang, X., Chen, H., Godfray, H.C.J., Wright, J.S., Hall, J.W., Taylor, J., 2019. Managing nitrogen to restore water quality in China. *Nature* 567 (7749), 516–520. <https://doi.org/10.1038/s41586-019-1001-1>.
- Zhang, L., Wei, C., Zhang, K., Zhang, C., Fang, Q., Li, S., 2009. Effects of temperature on simultaneous nitrification and denitrification via nitrite in a sequencing batch biofilm reactor. *Bioproc. Biosyst. Eng.* 32 (2), 175–182. <https://doi.org/10.1007/s00449-008-0235-3>.
- Zhang, Q., Liu, S., Wang, T., Dai, X., Baninla, Y., Nakatani, J., Moriguchi, Y., 2019. Urbanization impacts on greenhouse gas (GHG) emissions of the water infrastructure in China: trade-offs among sustainable development goals (SDGs). *J. Clean. Prod.* 232, 474–486. <https://doi.org/10.1016/j.jclepro.2019.05.333>.
- Zhong, R., Ren, X., Akbar, M.W., Zia, Z., Sroufe, R., 2022. Striving towards sustainable development: how environmental degradation and energy efficiency interact with health expenditures in SAARC countries. *Environ. Sci. Pollut. Res.* 1–18. <https://doi.org/10.1007/s11356-022-18819-6>.
- Zou, L., Zhou, M., Luo, Z., Zhang, H., Yang, Z., Cheng, H., Ai, H., 2022. Selection and synthesis of multi-carbon source composites to enhance simultaneous nitrification–denitrification in treating low C/N wastewater. *Chemosphere* 288, 132567. <https://doi.org/10.1016/j.chemosphere.2021.132567>.