

## Review of planning and capacity analysis for stations with multiple platforms – Case Stuttgart 21

Hansen, Ingo A.

**DOI**

[10.1016/j.jrtpm.2016.12.002](https://doi.org/10.1016/j.jrtpm.2016.12.002)

**Publication date**

2017

**Document Version**

Accepted author manuscript

**Published in**

Journal of Rail Transport Planning & Management

**Citation (APA)**

Hansen, I. A. (2017). Review of planning and capacity analysis for stations with multiple platforms – Case Stuttgart 21. *Journal of Rail Transport Planning & Management*, 6(4), 313-330.  
<https://doi.org/10.1016/j.jrtpm.2016.12.002>

**Important note**

To cite this publication, please use the final published version (if applicable).  
Please check the document version above.

**Copyright**

Other than for strictly personal use, it is not permitted to download, forward or distribute the text or part of it, without the consent of the author(s) and/or copyright holder(s), unless the work is under an open content license such as Creative Commons.

**Takedown policy**

Please contact us and provide details if you believe this document breaches copyrights.  
We will remove access to the work immediately and investigate your claim.

## **Review of planning and capacity analysis for stations with multiple platforms – case Stuttgart 21**

Ingo A. Hansen<sup>a,b,c</sup>

<sup>a</sup> Delft University of Technology, Stevinweg 1, 2611EH, Delft, The Netherlands

<sup>b</sup> Beijing Jiaotong University, Beijing, P.R.of China,

<sup>c</sup> Southwest Jiaotong University, Chengdu, P.R. of China

### **Abstract**

The master plan, design and capacity analysis of the future network timetable and track infrastructure of the project known as Stuttgart 21 (Germany) is reviewed with focus on the methods and results for capacity estimation of the planned through station close to the city center. The methods used and results reported for the capacity analysis of the network timetable and in particular the main through station since the first feasibility studies in 1994, complementing timetabling and operations research analysis in 1997 until the robustness analysis in the scope of the stress test simulations are described in detail in order to identify and discuss the critical issues. The shortcomings of the original approach consisting of a periodic network timetable design, queuing models for the estimation of the waiting probability and queue length for the purpose of timetabling and estimation of the operations quality respectively, as well as multiple stochastic simulations are explained and the consistency of the recent stress test simulations are examined.

Keywords: timetabling; capacity analysis; station; queuing; simulation; operations quality

### **1. Introduction**

Historically, the main railway routes in big European cities (e.g. London, Paris) were mostly aligned radially and the terminal stations located in the periphery of the city center. The transfer of passengers between the different terminal tracks, stations and lines of major central stations required rather long and inconvenient walking distances between different platforms and local public transport access, egress or transfer modes in case the terminal stations were situated at different edges of the city center, like still today e.g. in Paris (Gare du Nord, Gare de l'Est, Gare de Lyon) and London (King's Cross/St. Pancras, Euston, Paddington, Victoria, Waterloo).

The existing terminal stations in a lot of big cities consist mostly of a large number of stub-end tracks, many platforms, a large-scale central hall for ticket sale, passenger processing, waiting and commercial shops, a large station square with many car parks, taxi stands, bus and tramway stops or broad stairways to/from underground metro stations apart from multi-lane access/egress roads and wide sidewalks. The terminal stations near to the city centre attract/distribute generally the highest number of passengers, visitors and traffic volume in cities and become easily congested in particular at big events, season peaks and traffic disruptions. Nearby railway yards and train depots occupy a lot of scarce urban development space and generate a lot of locomotive, railcar or train-set shunting to/from arrival and departure tracks, which may cross main line tracks and reduce their capacity.

The very high level of transport demand and supply, economic and social importance of big railway stations is permanently seeking for capacity extension, which is very difficult and costly due the scarcity and extremely high value of urban space in high-density built-up city centers. The growth of population, jobs, students and visitors and of local, regional, national and international railway transport in big cities implies a continuous high pressure on the existing capacity of the railway infrastructure that stimulates the planning and development of new infrastructure and use of more efficient rolling stock, train operation and intelligent traffic management.

The further increase of fast national and interregional railway traffic led in some cities to planning and construction of new transversal or circumferential railway routes between formerly independent lines or to a replacement of former terminal stations with stub-end tracks through new stations and platforms with through tracks. Examples for the comprehensive redesign, relocation and new construction of former terminal main stations including new underground city link in Germany are Berlin, Leipzig and the planning of Stuttgart 21. The latter project for construction of a completely new through station in Stuttgart including high-speed links to the airport Stuttgart and the city of Ulm was presented to the public 1994 and approved by the government 2005 (Fig. 1). However, the project was opposed by many inhabitants and finally accepted through plebiscite 2011.

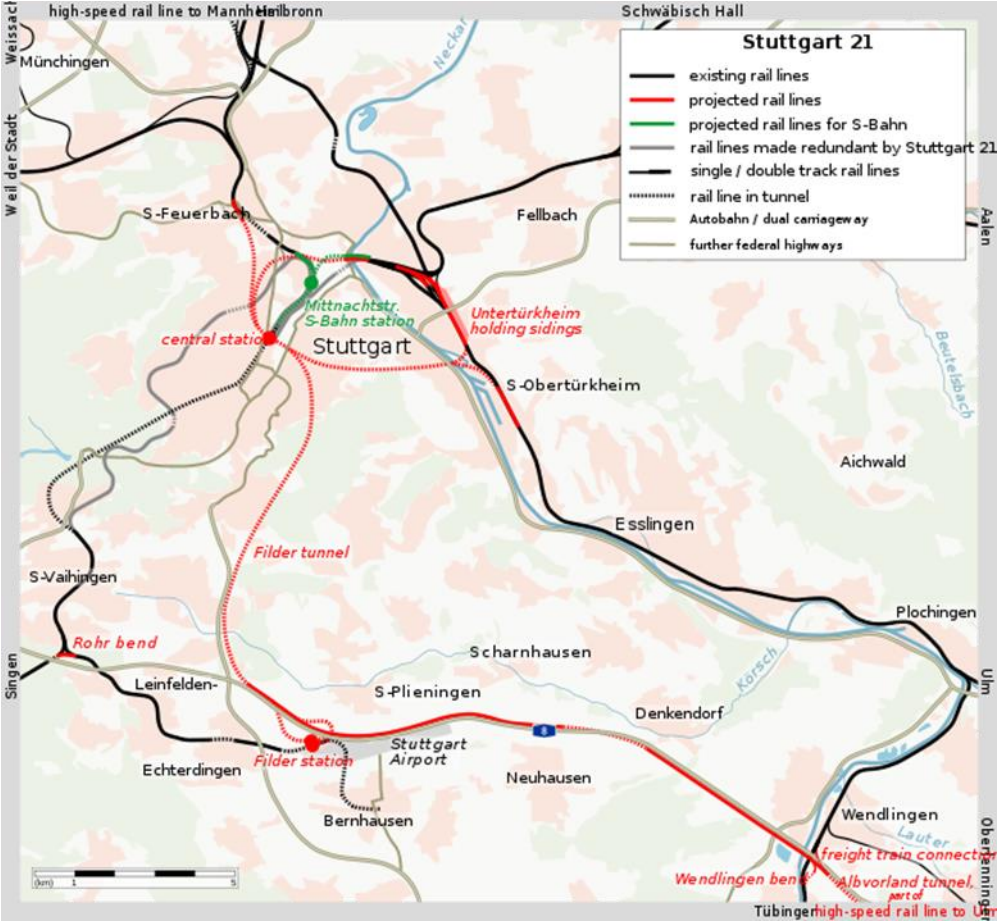

Figure 1: Map of existing and projected rail lines for Stuttgart 21 (source: Wikipedia)

The paper is organized as follows. In the next section the main objectives of the project known as Stuttgart 21 in Germany and the issues concerning the estimation of the future railway transport volume and the design of the line network and planned new through station for long-distance high-speed trains and regional train services are highlighted. The main features of the planned line network, train services, expected additional passenger volume are described in the third section. The fourth section contains a review of the analytical and simulation methods applied and of the main results for the capacity estimation of the new high-speed route section Stuttgart - Ulm focused on the quality of train operations of the through station in Stuttgart. In the fifth section the critical issues for the estimation of the timetable, station capacity, number of platform tracks and quality of operations are discussed. Finally, conclusions about the methods applied for the design and capacity estimation of railway stations with multiple tracks are drawn and recommendations given for future research.

## **2. Objectives and issues**

The main goal of the project Stuttgart 21 consists of the integrated (re-)novation, relocation and new construction of the railway node Stuttgart including a high-speed route to/from Ulm and a direct link to the airport Stuttgart in order to increase the number of scheduled long-distance trains/day by 75% and the number of short distance trains/ day by 56% according to the operations scenario 2015 and to reduce the trip time, where possible (Eisenbahn-Bundesamt, 2005 p. 48 and 154). Furthermore, 80 ha of current railway area in the city center would be cleared for urban redevelopment (Heimerl, 1994). The existing stub-end terminal station with 16 platform tracks would be replaced by a new through station with 8 tracks and 4 platforms, while the existing depot tracks would need to be relocated to a suburban shunting yard (Fig. 2). The new through station would be called by all high-speed and regional railway lines, except the metropolitan rapid transit, called S-Bahn, lines, which will continue to operate underground the existing main station. The new to build high-speed route Stuttgart – Ulm would be connected to the new through station including a fast direct link to the airport rail station, which so far is linked only by the S-Bahn network from the western side. The dedicated S-Bahn network in Stuttgart is not shown in Fig. 2.

The project Stuttgart 21 is characterized by a number of political, environmental and technical issues:

- High-speed railway network development and environmental protection in densely-built-up metropolitan areas;
- Urban redevelopment of railway areas situated near the city center;
- Accessibility of railway stations and interconnection between high-speed, regional and urban transit lines;
- Performance of a stub-end railway station in comparison with a through station
- Safety of large underground railway stations;
- Costs and benefits of high-speed railway projects;
- Mega transport infrastructure project governance and public participation.

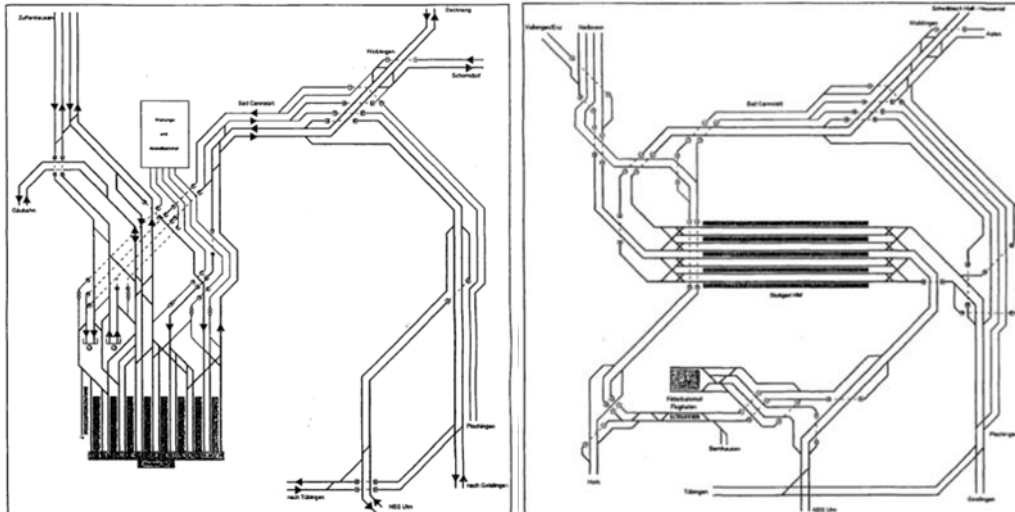

Figure 2: Track layout of the existing main railway station Stuttgart (left) and of the planned new underground station Stuttgart 21 including the new high-speed link to the new airport station and Ulm (right) (source: Heimerl, 1997a)

The construction works of the new underground main railway station, which started 2010, generated a lot of protests by many inhabitants, because old trees in the castle park were cut and the mineral sources in the ground might be affected (Spiegel Online International, 2010). One question is, whether the expected changes of travel distances and times of the high-speed and regional lines due to the new track alignment and construction of the underground station can compensate the environmental damage in a very sensitive historic urban park? Another important question is, whether the planned sale of in future obsolete railway area, which at present is needed for access tracks to/from the stub-end station and for stabling of trains in the depot, but in future will be sold to private investors for building new offices, commercial centers and apartments, can generate sufficient revenues to finance the high construction costs of the new underground railway infrastructure?

The new track infrastructure will induce changes of the network of regional and urban rapid transit lines, public transport passenger flows and of the timetables of high-speed, regional and urban transit lines. The question is, how much the accessibility and connectivity of the stations and lines, as well as the rail transit speed and frequency in the metropolitan area can be improved in order to increase significantly the patronage and modal share of the railway lines, stimulate the urban economy and improve the quality of living and environment in the city? Can the capacity of the existing quadruple track section Stuttgart-Cannstadt – Plochingen be increased through the new infrastructure with 8 platform tracks according to the operations scenario 2015 by 75% (long-distance trains) and by 56% (regional transit trains) to 270 trains/day on long-distance tracks and 295 trains/day on regional tracks respectively with acceptable operations quality ?

The safety of operation of the planned underground station in case of fire must assure that the evacuation of the station is finished within 21 minutes, while the emergency corridors must be kept smoke-free over 40 minutes. Which evidence exists that the design of the underground station platforms, stairs, corridors and main hall guarantees the required safe evacuation time of the predicted number of arriving and waiting passengers?

The total investment costs for the projected underground main station and a total of 57 km new tracks including 30 km of tunnels and 25 km of high-speed were originally estimated at around 4.6 billion Deutsche Mark (price level 1993), when first announced (Heimerl, 1994). In the meantime, the official cost estimate increased to € 6.5 billion (2013), while DB has to carry € 2 billion in cost overruns (Spiegel Online International, 2013). The additional revenues from ticket sale were initially estimated around 150 million Deutsche Mark/year, while the additional operating costs to increase the capacity were estimated being at almost the same order of magnitude, leading to a small financial profit (Heimerl, 1994). The economic benefits were estimated then at around 450 million Deutsche Mark/year with a resulting benefit/cost ratio of around 2.5. Since, this overly positive assertion in 1994 has been clearly superseded in the past years. The question remains, how such an enormous underestimation of project costs and late insight by the promoters has been possible?

Finally, the role of the responsible actors and public authorities, as well as the activities of the affected people in the decision making process needs to be highlighted. Starting from the initiative of director of the Transportation Science Institute at the University Prof. Heimerl), supported by renown academics in the field of railway transport economics and railway operations analysis respectively (Prof. Rothengatter, Prof. Schwanhäüßer, Prof. Martin). Their feasibility study, capacity analysis, simulation and evaluation convinced the federal, state and local political decision makers, as well as the managing directors and professionals of Deutsche Bahn to back the project, allocate funds and finance even in advance of federal state budget. They were all surprised by the suddenly uprising massive public protest and demonstrations against the project (Spiegel Online International, 2010), which also lead to the defeat of the ruling Christian Democratic Party in the municipal elections in city of Stuttgart 2009 and of the state elections in Baden-Württemberg 2011 and the victory of the Green Party. Nevertheless, in a state referendum end of 2011 the majority approved the continuation of the contested project. The question is, how a strong alliance of scientists, politicians and railway managers circumvented the growing public resistance against this project and why they succeeded, so far, in continuing the construction of such a big railway infrastructure project, whose financial and economic costs are known much higher than their expected benefits since at least 5 years?

### **3. Line planning, train frequency and passenger volume forecast**

The current and future railway lines serving the metropolitan area of Stuttgart can be split into (i) high-speed (ICE), (ii) regional (IC, RE, RB) and (iii) rapid transit (S) trains. The ICE -trains will extend the existing high-speed

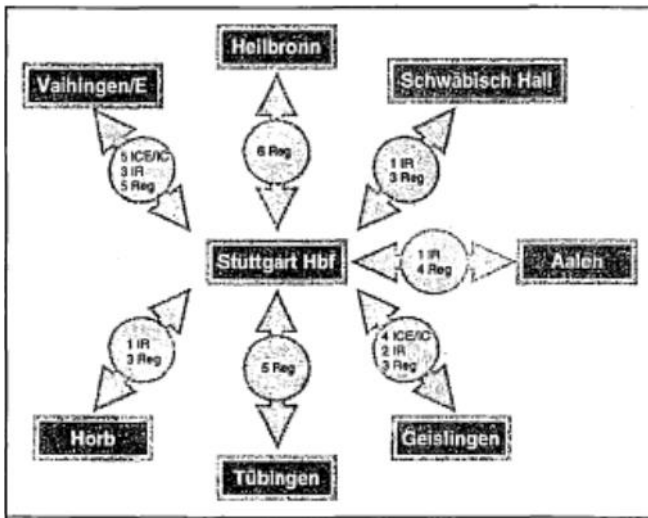

Figure 3: Planned ICE/IC, IR and Regional train frequencies per corridor during two hours according to the operational program for Stuttgart 21 (source: Heimerl, 1997a)

route from Mannheim via Stuttgart and the new planned high-speed route to Ulm including a direct link to the airport Stuttgart, which later on would be continued from Ulm to Augsburg and München (Fig. 3). The regional trains connect the city of Stuttgart via 4 corridors with the neighbourhood cities Vaihingen, Heilbronn, Schwäbisch Hall, Aalen, Geislingen, Tübingen and Horb (Fig. 4). The rapid transit trains operate from the main station to suburban quarters predominantly via dedicated (platform) tracks.

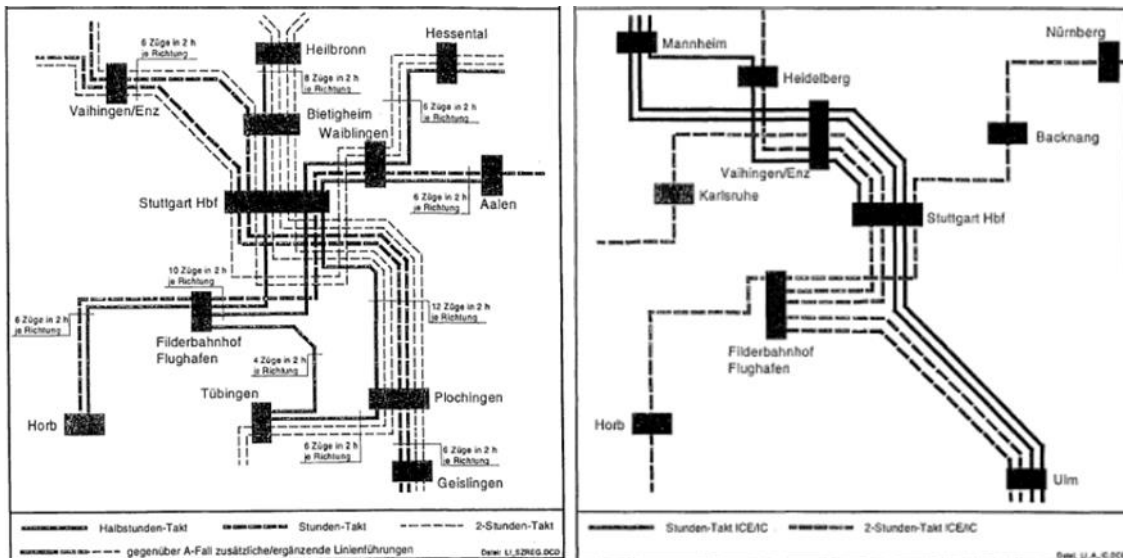

Figure 4: Network of regional (left) and ICE/IC (right) railway lines during 2 hour peak period of scenario "E" planned to call at the future main station Stuttgart 21 (source: Heimerl, 1997b Appendix 3)

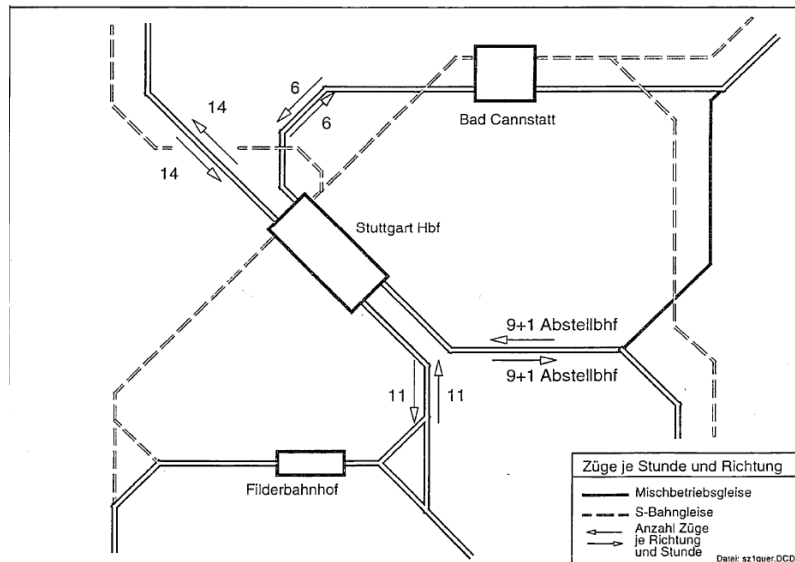

Figure 5: Extended number of trains per peak hour on the access routes to/from the future main station Stuttgart of scenario “E” (source: Heimerl, 1997b, Appendix 6 p. 27)

The operational program for the originally projected horizon 2010 consisted of an integrated periodic timetable for (i) 3 high-speed lines (max. speed 250 km/h, once per hour) calling at Stuttgart main station and one of the three also at the airport station, (ii) 4 transversal regional lines with a max. speed 160 km/h and twice per hour frequency plus 4 additional transversal train lines (twice an hour) partly to/from other destinations/origins, while (iii) each of the 6 rapid transit lines are scheduled at 15 minute intervals. In total, the ICE/IC/EC- and regional trains in the operations scenario “A” were expected to call 59 times at the planned main station during a peak period of 2 hours in both directions. The operations program for the increased train supply scenario “E” contained even a total of 82 trains calling at the planned main station per peak hour (Fig. 5).

One of the most critical parameters for the feasibility of the operational program is the scheduled dwell time of the different train lines at the planned new through station. According to the analysis of the timetables of long-distance trains in German big cities the average scheduled dwell time of ICE-trains at through stations was 2.02 min., while the average scheduled dwell time of IC-trains at stub-end and through stations was 2.62 min. (Heimerl, 1997b Table 2-1, p. 4). If only the shortest scheduled dwell times were considered the average values were 1.9 min. for ICE- and 1.95 min. for IC-trains. The standard dwell time for long-distance trains at major through stations of Deutsche Bahn is indeed 2.2 min. (DB Netz Richtlinie 405.0102 Appendix 2 Table 203 p. 203).

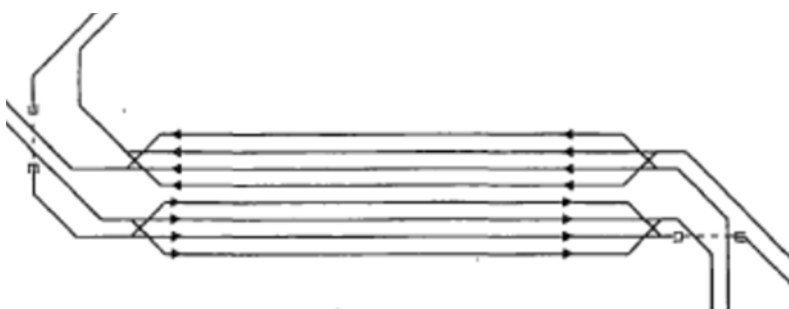



Figure 6: Principle track layout of the future main station Stuttgart 21 with transversal corridors (source: Heimerl, 1997a)

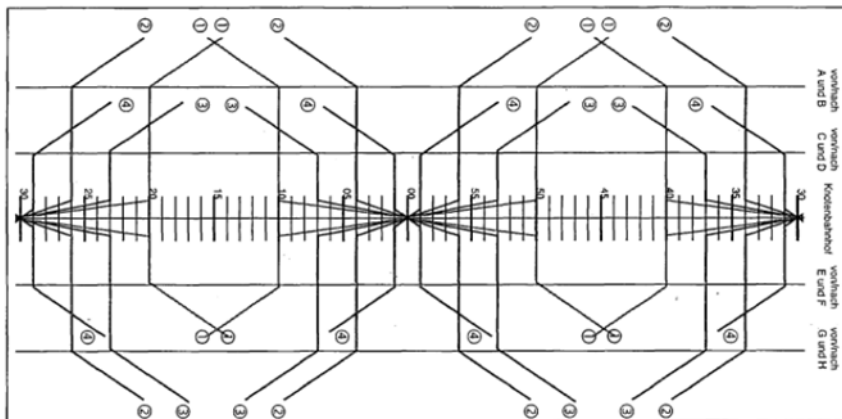

Figure 7: Integrated periodic graphical timetable for a railway node called by 4 lines (source: Heimerl, 1997a)

The integrated periodic timetable of the less-frequent long-distance and higher-frequent regional trains from/to 4 double-track corridors requires a track-layout with one grade-separated crossing and two double-scissor crossovers and switches on each side of the through station consisting of 8 tracks (Fig. 6). This allows for simultaneous train arrival or departure from/to each of the four corridors in both directions, but a minimum interval between the arrivals and departures respectively of each pair of trains from/to the same corridor in order to distribute over and merge respectively from the two corresponding platform tracks (Fig. 7).

The minimum headway times between the approaching and leaving trains respectively at each route node of double crossover and switches, as well as the dwell times needed for boarding, alighting and transfer govern the feasibility and capacity of the whole periodic network timetable and of the main station node. This implies automatically, waiting times for the feeder and distributor trains preceding and following the long-distance or prioritized regional trains on the same open track of twice the minimal headway time plus the minimum dwell time. If these critical parameters were designed too small or the trains were delayed more than the buffer time tolerates, the train operations of the main transfer station would be disturbed regularly (see section 4 for more detailed analysis).

The planned new railway infrastructure and train services were expected to generate at least 2,5 million additional passengers/year and 620 million passenger-km on the long-distance lines mainly due to an estimated strong modal shift from regional car transport based on an assumed ticket price of DM 0.20/P-km (corresponding € 0.10/P-km nowadays) and even around 500,000 passengers more in case the proposed urban redevelopment on the railway ground and a new exposition center at the airport would be realized (Heimerl, 1994 p. 47).

A maximum (minimum) volume of 4.8 (2.2) million additional regional and local railway passengers per year was forecast depending on whether an interconnection of the rapid rail transit lines between the north and the east by a new S-Bahn station in the middle of the planned new housing development area was built or not. While the new underground main railway station would not have a significant impact on the regional railway trip times, the latter new S-Bahn station was estimated to

attract many new rail passengers and reduce the trip times for regional and rail transit passengers by 1 million hours/year (Heimerl, 1994 p. 53).

#### **4. Capacity analysis**

The challenge is to synchronize the arrival and departure times of the passenger trains approaching at different speeds to the main station such that the periodicity and higher frequency of the regional lines matches with the arrival and departure times of the less frequent high-speed trains, while the timetable is conflict-free, contains sufficient buffer times and offers the least waiting times for transfers.

The capacity analysis of the planned new track infrastructure was realized in two stages 1994 and 1997 respectively and consisted of two parts:

- I. Microscopic train simulations of the timetable and
- II. Detailed analysis of track occupation times and operations quality.

##### **4.1 Timetable simulations**

The microscopic train simulations were performed by the train operating company Deutsche Bahn and based on the planned operations program 2010 of the afternoon period 15.00 – 19.00 h for, both, the network with the existing stub-end main station and the planned through station according to (a) given, eventually slightly adapted arrival and departure times and (b) random primary delays (50 cycles) of approaching trains at cordon sections in direction to the main station drawn from a given distribution of Deutsche Bahn (Tab. 5) by means of the tool UX-SIMU developed at the University of Hannover.

The more detailed review and analysis of the simulation output of track occupation times from UX-SIMU and the estimation of the number of platform tracks needed, as well as of the operations quality was done by Verkehrswissenschaftliches Institut of the RWTH Aachen (Schwanhäußner, 1994 and 1997). In particular, the mean and variation coefficient of the headway times and track occupation times for each platform track were calculated for estimating the probability to exceed a certain level of capacity use of each of the two independently served groups of platform tracks per direction (tracks #1-4 and #5-8 respectively). The estimation was based on a queuing model for General Independent distributions G/G/s proposed by Fischer & Hertel (1990) and the resulting queues were compared with certain predefined levels of operations quality:

- Probability to exceed capacity < 0.01 means very good quality but not economic
- Probability to exceed capacity = 0.025 means satisfactory quality and highly economic
- Probability to exceed capacity > 0.05 means deficient quality and no more marketable.

The resulting expected operations quality of the planned new main through station had to be compared with the existing stub-end main station with 16 tracks based on the same operations program 2010.

The simulations (scenario A) of the metropolitan network timetable included extra running time margins on the northern corridor before arrival at the main station for ICE-trains of 2.5 min. and on

the southern corridor of 2.0 min, and 1.0 min. respectively on both corridors for the regional trains, while the minimum dwell time for all trains were kept at 2.0 min. The reported simulated average additional train delays at arrival for long-distance trains were 0.12 min/train and 0.19 min/train for regional trains, while the long-distance trains reduced the delays by 0.40 min/train and the regional trains only by 0.07 min/train (Heimerl 1994 Tab. 4.4 p. 34). The same standard input distributions of DB for simulation of the effects of randomly inserted train delays were applied during the stress test in 2011 (Landeszentrale, 2011, SMA, 2011).

The reported platform track occupation varied between 39% and 52% with an average of 45%. Heimerl (1994 p. 36) concluded a satisfactory use of the platform tracks and even no critical track occupation times if the scheduled dwell times were extended to 3 min. He asserted finally that the new main station as through station with 8 tracks is sufficiently designed for the assumed operations program (1994 p. 37).

#### 4.2 Analysis of track occupation times and operations quality

The reported mean headway time of 3.39 min. and 3.56 min. at the planned main through station for both platform track groups are almost the same, while their variation coefficient of 0.685 and 0.546 respectively is somewhat lower in comparison to a usual value at German stations of 0.9 (Tab. 1). Schwanhäußer doubted himself, whether such rather small variation coefficients of the arrival headway times, which correspond to excellent timetable quality, can be realized in future. The mean track occupation times of around 7 min. and their coefficients of variation respectively of around 0.28 do not differ much per direction.

Table 1: Mean and coefficient variation of headway time and platform track occupation time (source: Schwanhäußer, 1994 p. 7)

			Mean [min]	Coefficient of variation
Arrival headway time	Tracks 1-4	West-East	3.39	0.685
	Tracks 5-8	East-West	3.56	0.546
Track occupation time	Tracks 1-4	West-East	6.90	0.286
	Tracks 5-8	East-West	7.08	0.274

The change of these values as function of different levels of capacity use (from 80% to 160% in steps of each 10%) was calculated in order to estimate the corresponding probabilities of exceeding the platform track capacity (Tab. 1). Schwanhäußer concluded 1994 from Tab. 2 that the track group 1-4 in the direction West to East would be totally occupied for the given operations program 2010, because the probability of exceeding the tolerated level of 0.5 means deficient operations quality, while the tracks in the opposite direction would still have 20% reserve capacity.

Then, Schwanhäußer estimated the impact of the number of platform tracks per direction on the operations quality by means of the same queuing model and showed that 5 tracks per direction would enable an almost very good operations performance. He asserted in 1994 explicitly that the

planned through station with 4 platform tracks per direction would lead in combination with the assumed scarce minimum dwell times (2.0 min.) for this operations program to satisfactory up to deficient operations quality.

Table 2: Probability of exceeding capacity as function of level of platform capacity use (source: Schwanhäußer, 1994 p. 10)

Level of capacity use [%]	Tracks 1-4	Tracks 5-8
80	0.016737	0.003071
90	0.032384	0.007880
100	0.057298	0.017777
110	0.094316	0.033153
120	0.146266	0.067517
130	0.215458	0.117889
140	0.303145	0.190035
150	0.408841	0.289806
160	0.529766	0.415966

Furthermore, he investigated the impact of a more robust variation coefficient of the arrival headway times (0.85) and of the track occupation times (0.30), as well as of an increase of the mean dwell time to 3.0 min. on the operations quality. In this scenario the number of 4 platform tracks per direction would not be sufficient and he recommended in 1994 explicitly to choose 5 platform tracks per direction (p. 16) in order to avoid a bad operations quality in case the variation of the arrival headway times would increase a little. This would enable to put a higher weight on scheduled transfer connections between the lines at the through station and suggested to design to add a crossover between both groups of tracks in order to enable short turns and bi-directional use of tracks.

Concerning the capacity of the existing stub-end main station with 16 platform tracks Schwanhäußer stated, based on earlier studies, that the existing design contains some bottlenecks, which would lead to traffic congestion for the operations program 2010 in case of a very small increase of the train frequencies or larger variation of arrival headway times. He recommended a study of the feasibility of constructing a new grade-separated track connection for two tracks (#15 and 16) used by long-distance trains, so that an overload of two heavily occupied route nodes could be avoided in future.

Schwanhäußer expanded and revised his capacity analysis 1997 in order to clarify, whether 8 tracks for the new main station Stuttgart 21 would be sufficient and secure in future. In particular, the following critical parameters would be investigated more in detail:

- size of the dwell times,
- coefficient of variation of the train arrival intervals and of the track occupation times,
- time period of timetable simulation,
- minimum headway times and capacity on the access routes.

However, he did not doubt the application of the nominal dwell times at stations of Deutsche Bahn (2.2 min) proposed by Heimerl and even called them to be realistic (Schwanhäußer, 1997 p. 51).

The following quality indicators for modelling the performance of rail routes, route nodes and tracks were used:

- mean queue length during operations (mean waiting time/mean headway time),
- probability of waiting during timetabling,
- mean queue length during timetabling of train paths,
- extrapolation factor for determination of the tolerable maximum number of trains
- ratio of the existing and required fluidity of operations,
- speed quotient for the trains, whose travel time have been increased,
- track occupation ratio of critical block sections.

The tolerable queue length  $L_{WB}$  as function of the level of operations quality  $q_B$  was determined according to

$$L_{WB} = q_B \cdot 0.257 e^{-1.3pRz} \quad (1)$$

with  $pRz$ : probability of passenger trains.

The corresponding tolerable standard queue length values for passenger traffic only and freight traffic only are given in Tab. 3.

Table 3: Tolerable queue lengths as function of operations quality (source: Schwanhäußer, 1997 p. 20)

Operations quality level	$q_B$	Queue length passenger trains	Queue length freight trains
Very good	0.5	0.035	0.123
Satisfactory	1.0	0.070	0.257
Deficient	1.5	0.105	0.386

The tolerable waiting probabilities in front of a set of tracks according to Schwanhäußer were determined by the probability of shifting from the desired train paths (Tab. 4).

Table 4: Tolerable waiting probabilities in front of a set of tracks for timetabling (source: Schwanhäußer, 1997 p. 18)

Quality level	$q_B$	Waiting probability [%]	
		Passenger tracks	Freight tracks
Very good	0.5	1.0	5.0
Satisfactory	1.0	2.5	10.0
Deficient	1.5	5.0	15.0

Schwanhäußer (1997) applied his queuing model approach and software program called GLEISE for the estimation of track occupation times, waiting probability and quality of operations developed at RWTH Aachen based on earlier work of Hertel (1986) and Wakob (1985), while the blocking times

and arrival delay calculated by the synchronous micro-simulation tool UX-SIMU for timetabling were used as input. Conflict-free timetables with periodic line intervals of 30, 60 and 120 minutes respectively and random variations of the departure times were then simulated by means of the asynchronous software tool STRESI to estimate the waiting times on the access corridors due to merging of routes and overtaking. Finally, the waiting times of trains at the route nodes (Fig. 8) were estimated by means of the tool ALFA developed at RWTH Aachen and the consecutive train delays were calculated according to his own model (Schwanhäußer, 1974). The minimum headway times, expected consecutive train delays due to filtering of train paths at merges and nominal performance of the access routes was estimated by the analytical model of the RWTH Aachen called STRELE.

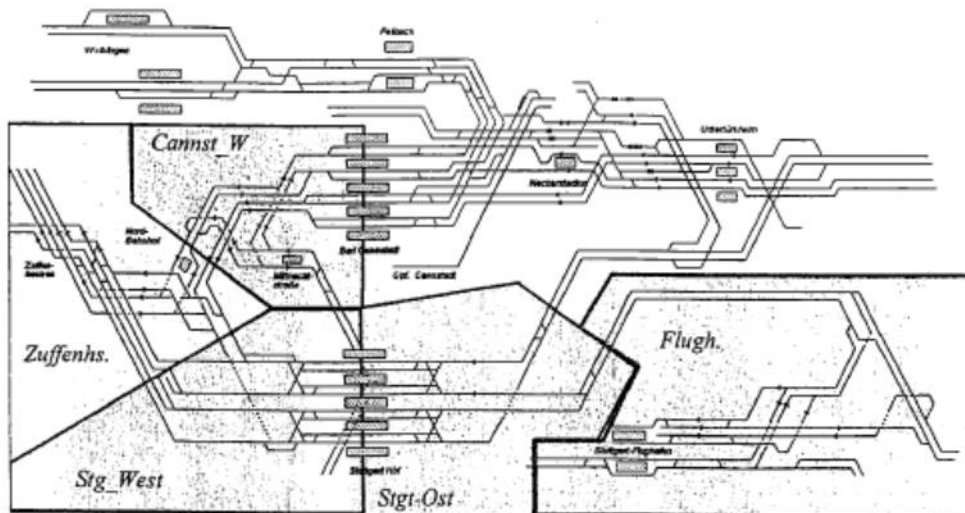

Figure 8: Track layout and division of the railway network Stuttgart 21 into route nodes (source: Schwanhäußer, 1997)

The resulting queue length after 100 timetable simulations in case of 8 tracks at the new main station in Stuttgart and 3 tracks in Ulm for trains in the down direction Mannheim – Ulm was 1.09 and 0.78 respectively in the opposite direction, while the probability of train delays increased to 0.5. The coefficient of variation of the train intervals at arrival in Stuttgart main station decreased from the earlier study 0.685 (1994) to only 0.55 (1997) in the direction Mannheim-Stuttgart and from 0.546 (1994) to 0.33 (1997) respectively in the opposite direction. The probability and amount of randomly inserted initial delays and of the dwell time extension per train category were not reported. It may be assumed that the standard values of Deutsche Bahn for capacity simulation studies were applied (Tab. 5).

Table 5: Standard initial train delays and dwell time extensions for capacity simulation of highly occupied stations (source: DB Netz, 1999, Richtlinie 405.0102 Appendix 3, Tables 302 and 303 p. 303)

Train category	Initial delays		Dwell time extension	
	Probability	Mean [min]	Probability	Mean [min]
ICE, IC	0.30	4.0	0.10	2.0
IR	0.60	4.5	0.10	1.0
RE, SE, RB	0.60	3.0	0.10	1.0
S	0.25	2.0	0.10	0.5

Freight	0.50	30	0.10	5.0
---------	------	----	------	-----

These standard values, however, were not verified for the railway network in Stuttgart by empirical measurements. In particular, the asserted probability and mean of dwell time extensions are remarkably low and may not be evident in practice. If higher values had been used in the simulation experiments, the coefficient of variation of the train intervals, amount of consecutive delays, delay probability at arrival, and mean delay per train predicted (Tab. 6) would surely be much higher and the expected level of operations quality much lower.

The nominal capacity  $N_{opt}$  of a railway route can be calculated as follows:

$$N_{opt} = T / (t_{zm} + t_{rm}) \quad (2)$$

with  $T$ : time period (usually 60 min),  $t_{zm}$ : mean minimum headway time [min] and  $t_{rm}$ : mean buffer time [min].

Table 6: Estimated probability of delayed train arrivals and mean delay per train at the planned main station Stuttgart (source: Schwanhäuser, 1997 Appendix 7, p. 109)

	Delay probability at arrival	Mean delay per train [min]
ICE, IC	0.54	4.39
IR	0.65	4.66
RE	0.37	2.79
Freight	0.46	4.83
All trains	0.45	3.71
Tracks 1-2	0.25	2.05
Tracks 3-4	0.55	3.99
Tracks 1-4	0.42	3.64
Tracks 5-6	0.51	4.30
Tracks 7-8	0.38	5.06
Tracks 5-8	0.44	4.39
Tracks 1-8	0.45	3.71

The estimated nominal capacity for each of the 4 main route sections to/from the planned main railway station Stuttgart is reported in Tab. 7. The very short mean minimum headway times on the planned new high-speed route Stuttgart – Ulm are based on the assumed implementation of a high-performance moving block signaling system, for which extremely short minimum headway times between ICE and RE trains between 1.0- 1.9 min have been simulated due to very short block sections (Schwanhäuser, 1997 Appendix 6 p. 97-102).

Table 7: Nominal capacity of the planned route Mannheim – Stuttgart –Ulm (source: Schwanhäuser, 1997 S. 40)

Route section	Stuttgart Airport - Main Station	Stuttgart Main Station - Vaihingen/Enz
---------------	----------------------------------	--

Direction	Ulm-Stuttgart	Stuttgart-Ulm	Stuttgart-Mannheim	Mannheim-Stuttgart
Mean minimum headway time $t_{zm}$ [min]	2.38	1.68	2.37	3.38
Mean buffer time $t_{Rm}$ [min]	3.33	2.23	3.35	3.16
Nominal capacity [trains/h]	10.5	15.4	10.5	9.17
Tolerable train number during peak hour ( $q_B < 1.5$ )	12	17	12	10

The number of required platform tracks  $S$  at the main station Stuttgart can be calculated approximately by dividing the mean track occupation time  $t_{Bm}$  through the mean minimum headway time  $t_{zm}$ :

$$S = t_{Bm}/t_{zm} \quad (3)$$

When using the estimated mean track occupation times (blocking times) for the tracks #5-6 in the direction Ulm-Stuttgart (Tab. 8), there would be 2.7 (rounded-up 3) tracks necessary instead of the planned two, while for the tracks #3-4 in the opposite direction 1.6 (rounded-up 2) were considered sufficient. The consecutive train delays due to merging of train access routes into the trunk network near to the future main station increase the scheduled track occupation times and were estimated through micro-simulation by the proven tool of RWTH Aachen called STRESI (Tab. 9). The arrival delays do not increase the mean headway times, but lead to a considerable increase of the coefficients of variation of the track occupation times, while waiting times at the departure increase the track occupation times. Schwanhäüßer (1997) divided the total main route Mannheim – Ulm into the two independently simulated parts from Stuttgart to Mannheim and Stuttgart to Ulm respectively with fixed departure times from the future main station Stuttgart according to the operations program given by Heimerl (1994, 1997).

Table 8: Mean track occupation times and number of required platform tracks at the planned main station Stuttgart (source: Schwanhäüßer, 1997, p. 42/43 and Appendix 4 p. 89\*)

	Mean track occupation time [min]	Mean minimum headway time [min]	Number of required platform tracks
Tracks #1-2	(5.36*)	n.a.	n.a.
Tracks #3-4	5.49 (5.69*)	3.38	1.62 → 2
Tracks #5-6	6.45 (6.38*)	2.37	2.71 → 3
Tracks #7-8	(7.12*)	n.a.	n.a.

Table 9: Estimated consecutive train delays at departure of the future main station Stuttgart (source: Schwanhäüßer, 1997 p.44)

Route section	Mean consecutive train delay [min]	Probability of consecutive train delay
Stuttgart-Mannheim	3.25	0.31



Stuttgart-Ulm	3.47	0.07
---------------	------	------

The expected quality of operations for timetabling and train operations respectively was estimated on the basis of the operations scenario “A” for a total period of 4 hours from 14:00-16:00 h (normal traffic) and 16:00-18:00 h (peak traffic) as proposed by Heimerl (1997) with on average 25.5 trains/h corresponding to 31% use of track capacity (Schwanhäußer, 1997 p. 45), which assumed double occupation of platform track sections by short trains. The resulting number of trains scheduled, mean arrival headway times, mean service times, coefficients of variation of arrival headway and service times respectively, waiting probabilities, track occupation, queue length for timetabling of different platform track combinations of the main station Stuttgart are reported in Tab. 10.

Table 10: Estimated performance results for timetabling of operations scenario “A” of different track combinations during the period 14:00-18:00 h at the future main station Stuttgart (source: Schwanhäußer, 1997 Appendix 4 p. 89)

Tracks	#Trains	Mean arrival headway time [min]	Arrival coeff. of variation	Mean service time[min]	Departure coeff. of variation	Waiting probability	Track occupancy	Queue length
#1-2	23	9.52	0.642	4.39	0.855	0.042	0.231	0.011
#3-4	33	7.06	0.745	4.72	0.224	0.036	0.334	0.012
#5-6	31	8.03	0.751	4.81	0.247	0.028	0.300	0.009
#7-8	21	11.63	0.693	5.53	0.656	0.039	0.238	0.010
#1-4	56	4.18	0.748	4.83	0.484	0.014	0.289	0.004
#5-8	52	4.71	0.762	5.29	0.449	0.012	0.281	0.003
#1-8	108	2.25	0.746	5.06	0.463	0.001	0.281	0.000
#3-6	64	3.85	0.952	4.98	0.140	0.024	0.323	0.009

The smallest coefficients of variation of the headway times at arrival were expected to be 0.642 at the lateral platform tracks #1-2 (Mannheim-Stuttgart), which generated also the largest coefficients of variation of the service times (equal minimum headway times) at departure of 0.855 and the highest waiting probability of 4.2%. The latter corresponds to satisfactory operations quality (Tab. 3). In case of flexible use of one set of 4 platform tracks (#1-4 and 5-8 respectively) by any train in one direction, the operations quality for timetabling was considered as good (< 0.025 waiting probability). The queue length during train operations (Tab. 11) was estimated to be highest (0.0974) at the central platform tracks #5-6 (Stuttgart-Mannheim) and little less (0.874) at the central tracks #5-6 (Stuttgart-Ulm). These correspond still to a satisfactory operations quality (< 0.100) due to a tolerated dwell time extension of 1.0 min and double occupation of platform tracks (Schwanhäußer, 1997 p. 50).

The estimated mean waiting probability for trains at all platform tracks increased considerably from 1% in timetabling to 6.7% in operations, while the average queue length grew negligibly from 0.00 in timetabling to 0.03 in operations. The share of trains that benefit from double occupation of platform track sections was very high at the tracks #1-2 (42%) and tracks # 7-8 (35%) respectively, and much lower at the other platform tracks. The risk of waiting at arrival and/or departure was kept

on these lateral platform tracks at a satisfactory level in timetabling only by assuming such a high probability of double occupation of tracks. During operations the risk of waiting before the trains' arrival and departure at the main station was estimated higher than 10% even in conjunction with double occupation of platform track sections, which means the expected quality of operations should have been judged deficient instead of "optimal" (Schwanhäußer 1997 p. 51).

Table 11: Estimated performance results for train operations of operations scenario "A" of different track combinations during the period 14:00-18:00h at the future main station Stuttgart (source: Schwanhäußer, 1997 Appendix 4 p. 89)

Track	# Trains	Mean arrival headway time [min]	Arrival coeff. of variation	Mean departure service time [min]	Departure coeff. of variation	Waiting probability	Track occupancy	Queue length	Double occupation [%]
#1-2	23	9.52	0.770	5.36	0.856	0.117	0.281	0.044	42.3
#3-4	33	7.06	0.839	5.69	0.500	0.168	0.403	0.087	6.1
#5-6	31	8.03	0.832	6.38	0.582	0.181	0.397	0.097	9.7
#7-8	21	11.63	0.759	7.12	0.693	0.104	0.306	0.039	34.8
#1-4	56	4.18	0.825	5.75	0.584	0.044	0.344	0.020	11.9
#5-8	52	4.71	0.829	6.82	0.603	0.054	0.362	0.026	14.8
#1-8	108	2.25	0.828	6.27	0.584	0.007	0.348	0.003	13.3
#3-6	64	3.85	0.969	6.30	0.496	0.099	0.409	0.070	0

The timetable simulation and analysis of capacity use, waiting probability, queue length and operations quality was done also for an increased train supply scenario "E" of in total 149 trains in the 4-hour afternoon period to/from the main station Stuttgart (Tab. 12). Although the overall track occupation of the platform tracks and station yard increased to 49.7%, the estimated waiting probability and queue length during operations on each pair of platform tracks changed only marginally in comparison to scenario "A" with 28% less trains. This was achieved by small changes of the scheduled departure times, flexible regulation and routing of delayed trains, such that their scheduled slots were filled up by other delayed trains, little lower than standard arrival delay probabilities and amount of delays (Schwanhäußer, 1997 p. 55).

Table 12: Estimated performance results for train operations of operations scenario "E" of different track combinations during the period 14:00-18:00h at the future main station Stuttgart (source: Schwanhäußer, 1997 Appendix 4 p. 88)

Track	#Trains	Mean arrival headway time [min]	Arrival coeff. of variation	Mean departure service time [min]	Departure coeff. of variation	Waiting probability	Track occupancy	Queue length	Double occupation [%]
#1-2	33	6.97	0.661	4.45	0.855	0.095	0.319	0.035	50.0
#3-4	42	5.76	0.690	5.58	0.530	0.171	0.484	0.098	9.1
#5-6	42	5.68	0.679	5.57	0.547	0.176	0.490	0.102	12.5

#7-8	31	7.75	0.612	5.56	0.763	0.083	0.359	0.033	45.6
#1-4	75	3.19	0.651	5.49	0.598	0.050	0.430	0.024	13.8
#5-8	73	3.27	0.708	6.45	0.625	0.108	0.493	0.069	14.8
#1-8	149	1.61	0.766	5.71	0.571	0.119	0.497	0.079	10.2
#3-6	81	2.98	0.817	5.92	0.617	0.031	0.460	0.020	17.4

The infrastructure capacity of 4 network track infrastructure options (Fig. 8) was analyzed more in detail by means of the software tool ALFA of the RWTH Aachen in order to discover possible bottlenecks on the access/egress tracks and to determine possibly required upgrading measures for route sections and route nodes heavily occupied in future by the scheduled trains to/from the main station Stuttgart. The signal block spacing on the existing approach routes from Mannheim between Zuffenhausen and the main station Stuttgart was considered deficient and would need to be upgraded in order to reduce the long blocking times of approaching trains. The infrastructure option "P", that contains an additional connections of the long distance tracks to/from Mannheim via the existing Pragtunnel to the tracks running from/to Bad Cannstadt (Fig. 9) was considered by Schwanhäußer (1997 p. 65) as economical option for upgrading offering still a satisfactory operations quality in case the train intensity grows like scenario "E" ( $q_F = 1.36$ ,  $q_B = 0.98$ ).

Deutsche Bahn was forced 2011 by the state government to execute a stress test of the capacity analysis and simulation results for the project Stuttgart 21 (DB Netz, 2011) as part of the arbitration due to the ongoing public opposition against the construction of the planned underground main station. Deutsche Bahn was obliged to prove that 49 train arrivals were possible with good operations quality at the planned main station during the peak hour from 7:00-8:00 a.m. on the basis of a basic periodic timetable of 26 trains/h in the whole regional railway network. The demanded increase of capacity of the new underground main station was 30% compared with 37 train arrivals/h of the existing sub-end main station.

Since Deutsche Bahn defined in her operations design code valid since 2008 the following four performance levels (DB Netz, 2011 p. 23): (1) Premium, (2) Economically optimal, (3) Risk-affected, and (4) Deficient. The level 1 is characterized by only very small growth of consecutive train delays and a clear reduction of the total train delays between the entry to and exit from the considered network due to existing timetable margins. The second level means the sum of consecutive train delays in case of disturbance remains acceptable and does not exceed a maximum cumulated mean delay of up to 1 min/passenger train in a certain part of the network and up to 0.5 min/passenger train at station heads within a rather limited period of time, while the sum of train delays does not change significantly between entry to and exit from the network. The level 3 stands for considerable further growth of the mean consecutive passenger train delays to more than 1 min and an increase of the total train delay between entry to and exit from the network. The level 4 suffers from a high increase of train delays in the network and is not marketable.

The standard values for inserting initial (primary) delays at the network borders and at stations according to the updated DB Netz code 405 have been slightly adapted with regard to the former values (Tab. 5), such that the probability and mean initial delay for long distance trains at the borders are slightly increased, while the dwell time extensions remain the same for all train categories (Tab. 13). The simulations of the expanded periodic network timetable of the stress test assumed a densification of the block signal distances on the existing routes and an overlay by the conventional

intermittent & continuous signaling and safety systems (PZB/LZB) on the planned high-speed routes, such that the rolling stock for the regional lines can achieve on the whole network a minimum headway of 2.5 min and can operate also on the high-speed route to Ulm and Stuttgart airport. The stress test simulations were done by means of the synchronous simulation tool RailSys (RM Consultants).

Table 13: New standard initial train delays and dwell time extensions for capacity simulation of highly occupied stations (source: DB Netz, 2011 Teil 1 p.21)

Train category	Initial delays		Dwell time extension	
	Probability	Mean [min]	Probability	Mean [min]
Long distance	0.50	5.0	0.10	2.0
Regional distance	0.60	4.5	0.10	1.0
S-Bahn	0.25	2.0	0.10	0.5
Freight	0.60	19	0.10	5.0

The simulated approach speed for train arrival at the platform tracks of the main station was 100 km/h (#4-5), 80 km/h (#1-3, 6-8), and 60 km/h respectively in case of use of alternative crossover. The standard minimum overlap distance of 200 m behind signals and 100 m behind switches and crossings respectively were adapted up to 300 m in order to account for the increase of the braking distance due to the design track descent of 15‰ and 3.6‰ respectively. The stepwise decrease of the approach speed to 60 km/h and then 20 km/h in case the platform track is still occupied (double occupation) was simulated by a single-step reduction of the approach speed to 30 km/h. The microscopic simulation generated conflict-free blocking time graphs for the whole network timetable with buffer times of, in general, at least 1 min between any pair of trains in the same direction and 2 min between crossing of train pairs in opposite direction during the peak hour according to the design code 405 of DB Netz. A few shorter buffer times were observed by the auditor in particular at the platform track #4 for some long distance trains, whose the scheduled dwell time was at least 180 sec (SMA, 2011).

However, the exact size of buffer times is no more relevant in the simulation of random initial disturbances, as the scheduled buffer times, dwell time margins and running time supplements are automatically used and the lack of robustness of the timetable against disturbances would be measured by an increase of the consecutive and total delays in the network. The regular running time supplements of 5% for long distance trains and 4% for regional trains, as well as the so called construction supplements were incorporated into the simulated network timetable (Tab. 14), such that the total time margin of the scheduled and simulated running and dwell times became 20% for the long distance trains and 15 % for the regional trains. These timetable margins were distributed partly as pure running time reserve and partly as dwell time reserve. Even, the auditor SMA qualified the given running time reserves by Deutsche Bahn as very high, because construction sites are usually not considered in train simulations.

Table 14: Size and distribution of the regular running time and dwell time reserve used in the stress test simulations (source: SMA 2011)

Train category	Regular reserve	Total reserve	Reserve without	Excess running time	Excess dwell Time reserve

	[%]	[%]	regular reserve [%]	reserve [%]	[%]
Long distance	5	20	16	10.5	5.5
Regional	4	15	12	4.5	7.5
S-Bahn	3	13	10	4.0	6.0

The time for set-up of crossing routes at the entry and exit of the main station applied in the simulation was 150 sec and 55 sec respectively, while some reported headway times at the platform tracks #1, 3, and 4 varied around 180, 195, and 140 sec respectively. The least headway times (without buffer times) simulated between two trains on the route from the main station to the airport were 100 sec, and 140 sec in the opposite direction; on the routes from Bad Cannstadt and Zuffenhausen to the main station the minimum headway times realized were 180 sec and 140 sec respectively.

The minimum dwell times at the main station for starting and through trains applied in the stress test simulation runs was 150 sec for long distance trains and 90 sec for regional trains (Tab. 15). As the scheduled dwell times were 30 sec larger, the simulated trains arriving late due to previously inserted initial delays could generally reduce their arrival delay until departure by 30 sec apart from exploiting the scheduled running time reserve. For long distance trains that finish their line service at the main station the corresponding minimum dwell times were 60 sec longer, while their scheduled dwell time was even 120 sec longer. Similarly, the scheduled dwell times of regional trains at the main station were 30 sec longer than the minimum dwell times for starting & through trains, and even 90 sec longer for terminating trains.

Table 15: Scheduled and minimum dwell times at stations per train category used in the stress test simulations (source: SMA 2011)

Location	Train category	Type of station	Scheduled dwell time [sec]	Minimum dwell time [sec]
Stuttgart Main Station	Long distance	Start & through station	180	150
		Terminal	300	210
	Regional	Start & through	120	90
		Terminal	240	150
Other stations	Long distance	Through	120	90
	Regional	Through	60(45)	45(30)
S-Bahn	Local	Through	30	30(20)

The plausibility of the above reported minimum dwell times was checked by the auditor SMA based on the standard values of the code 405 of DB Netz, statistics of the boarding and alighting passengers at the main station of Stuttgart in the first half year 2010 and reported dwell time statistics for long distance and regional trains of Deutsche Bahn at comparable stations with similar track layout and operations (Düsseldorf, Duisburg, Mainz and Karlsruhe with up to 2 min and 1 min scheduled dwell times respectively (SMA, 2011).

The stress test simulation period lasted in total 9 hours from 4:00-13:00h, of which only the output of the period from 6:00-10:00h was considered in the analysis in order to cover a representative, full circulation time of almost all the regional train lines. The required periodic timetable of the different railway lines and synchronicity of the arrival and departure times of the long distance and regional trains at the major stations of the network including a partial mixed use of a few route and platform track sections by the local S-Bahn and some regional trains fulfilled most of the demanded operational program. The simulation tool parameters were not verified before the test, because empirical data of the planned new network in Stuttgart were not available.

The stress test simulations were drawn 100 times randomly (Monte-Carlo) from the standard negative-exponential distributions of initial delays at the borders and dwell time delays according to Tab. 13, while the simulation model automatically searched for alternative individual train dispatching measures (move, hold, cancel ) in case of  $\geq 120$  sec delay, change of destination route at  $\geq 300$  sec delay, and change of local routing at  $\geq 30$  sec delay. The available excess running time, but not the regular running time supplement was used completely for recovery in case of delays. Delayed through trains stopped during the simulation runs at the scheduled stations only as long as the minimum dwell time required, thus could save at every intermediate stop 30 sec if there were no headway and route conflicts to other trains.

The simulation output of a number of long distance and regional lines was compared by the auditor SMA with the train delay statistics by Deutsche Bahn (LeiDis) of the corresponding routes saved during a morning period from 6:00-10:00h over 3 months in winter/spring 2011. The auditor concluded that the level of the observed train delays of the regional lines, whose lines did not follow the same routes as planned in future, did not match well with the simulated delays, but its level was generally lower. The observed level of train delays on the long distance lines observed corresponded roughly with the simulated one (SMA, 2011).

The multiple stochastic simulation runs of the stress test showed the following main results:

- The average train delay of randomly generated arrival train delay at the entry points of the network decreased from 263 sec/train by 29 sec to 235 sec/train at the exit points.
- The average inserted train delay at the entry points increased by 8 sec/train until the arrival at the planned new main station Stuttgart, decreased there during the stop until departure by 77 sec/train and increased from there by 9 sec/train until arrival at the exit points to 215 sec/train.
- The clear reduction of the total average train delays/train between the entry and exit points of the network indicated the quality level "Premium", while the slight increase from the entry points until the arrival at the main station Stuttgart and from the departure there to the arrival at the exit points of the network corresponded to the "economically optimal" quality level (DB Netz, 2011Teil 2 p.67).
- The sensitivity analysis of the simulation runs with respect to only the peak-hour traffic, in which the delayed trains could not use more than 75% of the available running time and dwell time margins for recovery decreased the overall reduction of the average delay/train from the entry points to the exit point to 20 sec/train, increased the average delay/train from the entry points to the main station up to 17 sec/train and from the

main station to the exit points by 11 sec/train, but the results did not change the previously assigned quality levels of operation (DB Netz, 2011 Teil 2 p.,112).

## 5. Discussion

The following discussion refers briefly to the shortcomings with respect to the past railway transport prognosis and a number of critical issues concerning the methods applied for the railway infrastructure capacity analysis. A critical review of the governance, project management, costs and benefits, and environmental impact of the project Stuttgart 21 is out of scope of this paper. Thus, the corresponding questions (section 2) cannot be answered here.

The original forecast of at least additional 2.2 million passengers/year for the regional and local rapid transit railway transport volume was based mainly on the proposed 50% increase of the train frequencies. The railway transport volume growth would be generated by only a marginal overall trip time reduction (Heimerl, 1994, Table 5.3 p. 53). An additional 400,000 passengers/year was predicted due to an additional S-Bahn station to be built near to the main railway station in order to improve the transfer between the different rapid transit lines. This means that much of the predicted passenger volume growth is expected to be induced not by the planned new high-speed and regional rail line infrastructure, but by the assumed increase of train frequency and the improvement of transfer to/from rapid transit lines. The predicted large increase of the railway transport volume seems to be very optimistic and did not take sufficiently into account the impact of future welfare, car ownership and competition between the transport modes on transport time and travel costs, in particular with regard to the development of other than commuter trips and low-cost air transport.

In fact, the total long-distance passenger volume of Deutsche Bahn decreased since 1994 from 150 million passengers per year to 120 million 2004 and since increased again to 130 million (Deutsche Bahn, 2014). Unfortunately, we do not know the absolute long-distance railway passenger volume in the area of Stuttgart in order to estimate ex-post the growth rate forecast in 1994, but we can assert that in the past the predicted passenger volumes and costs of railway transport in Europe were in general overly optimistic (Flyvbjerg, 2007, Flyvbjerg et al., 2008). In most cases they underestimated considerably the time needed for planning, detailed design and construction, the increase of investment costs and, in general, did not take into account of the strong negative impact on the performance, operating and maintenance costs, and revenues of the remaining conventional long-distance rail transport supply and demand.

The proposed operations program for the integrated periodic timetable of the planned long distance and regional railway lines (section 3) is governed by synchronizing the arrival, departure and running times of the regional lines with those of the long distance lines. Their entry and exit times to/from the considered network and running times were given by Deutsche Bahn, whereas the routing and train frequencies of the regional lines during off-peak and peak hours were demanded by the public transport master plan of the State. The feasibility study of the operations program by Heimerl (1994, 1997) was focused on the manual assignment of the capacity demand with the existing and planned new track infrastructure. Unfortunately, a macroscopic network timetable optimization model was not available at that time to investigate the effectiveness of essential infrastructure improvements in the conventional railway network and to assess their impact on the future volume and distribution of the passenger transport flows in the regional and urban railway network more accurately.

The methods for and results of the capacity analysis and timetabling in case of the project Stuttgart 21 have been presented rather comprehensively in order to better understand the practice of German railway operations research, which was described in the international literature only rarely (Schwanhäußer, 1994; Wendler, 2007; Lindner, 2011).

The following timetable and operations modelling aspects will be discussed more in detail:

- Scheduled dwell times and running time margins;
- Simulated train delay distribution, recovery and minimum headway times;
- Waiting probability and queue length in timetabling and operations;
- Operations quality level and indicators.

The scheduled dwell time of 2 min for long distance trains (DB Netz code 405.0102) at the main through station Stuttgart used in the studies by Heimerl (1997b) and Schwanhäußer (1997) in conjunction with the regular running time supplement of 5% was not evident, lack verification by empirical performance data of representative trains at similar stations and routes and may have biased the result of their capacity analysis and estimation of the expected operations quality respectively. The increase of the minimum dwell times (Tab. 15) and of the running time margins up to 20% that exceed the standard norm of DB Netz used for delay recovery in the stress test simulations by DB Netz (Tab. 14) generate arbitrarily an excessive amount of time margins during operations to recover from initial delays that is larger than the size of delays inserted randomly at individual points of the network (Tab. 13).

The reported slight decrease of the mean train delay between the entry and exit points of the network in the stress test simulations is due to the implemented strong dispatching algorithm in the tool RailSys (p. 16) and the very generous running time and dwell time margins of the timetable. Even at 75% use of the running time margin the mean train delay increased only slightly between the entry points at the network border and the arrival at the main station, decreased strongly during the stop and increased again slightly between the departure from the main station until the exit points of the network. In practice, however, the already delayed trains do rarely recover from an initial delay, but the delays accumulate, because the boarding and alighting times at the next stations increase on ground of more passengers waiting and the safety-first, defensive behavior of the train drivers, who cannot well assess the right starting point and braking distance without a reliable and accurate driver assistance system or automatic train operation (ATO) system. The very short mean minimum headway times on the planned high-speed section Stuttgart - Ulm of less than 2 min (Tab. 7) are still today not feasible in practice on dedicated railway lines with moving block signaling for (a mix of) long distance and regional trains even when equipped with automatic train control (ATC). Thus, the reported performance of the stress test simulations is much too optimistic in comparison to real operations experience!

The reference of the auditor SMA to corresponding train delay statistics compiled by the LeiDis train monitoring system and mean dwell time statistics of Deutsche Bahn at 4 similar stations is not valid, because the LeiDis data measure only the track occupation and clearance times at some open track block sections. The (standard) off-set of the train's running time to/from the stop position at the platform can only be estimated roughly without knowledge of the actual speed and deceleration rate of the individual trains.



The waiting probabilities on platform tracks were estimated by Schwanhäuser by means of queuing models for original and consecutive delays respectively. The waiting probability depends strongly on the density and variation of the train intervals at the block signal that protects the (platform) track section in question and of the order and variation of the minimum headway time due to switch of signal aspects, set-up/release of the routes and blocking time of the involved trains. The larger the coefficient of variation of the train interval and of the minimum headway times, and the higher the train number and density per time period, the higher the probability and amount of delays. The latter increase exponentially until the track capacity is saturated.

The reported coefficients of variation of the arrival headway times and of the minimum headway times at the platform tracks of the main station (Tab. 10-12) were calculated on the basis of output of microscopic timetable simulation runs, in which the network was separated artificially into two parts at both sides of the planned main station. The scheduled trains were generated for each side and direction independently and the platform track assignment adapted manually in order to increase the regularity of the timetable and achieve a more balanced use of the platform tracks. This procedure led in conjunction with the assumed elimination of original dwell time extensions to considerably lower coefficients of variation of the arrival headway times, in general, that corresponds to enforced higher regularity of the periodic timetable. The calculated coefficient of variation for the common sets of platform tracks #1-4, 5-8, and 1-8 in this approach produced even lower values than would be estimated according to probability theory. This inconsistency affects presumably the reliability and size of the corresponding estimates of the waiting probabilities and queue lengths. The queue length was kept only at an acceptable level, while it exceeded the maximum tolerated queue length on both pairs of the central platform tracks, because 45 to 50% of the simulated trains generated double occupation of track platform sections (Tab. 12).

The model for the estimation of the queue length (eq. 3) and their size in conjunction with the different levels of operations quality proposed by Schwanhäuser (Tab. 3) are somewhat arbitrary, as they were based on the results of an earlier (unpublished) study by his institute on only a single railway route (Cologne-Aachen) in 1984 and applied to the network in Stuttgart without verifying its validity for other networks. In his first feasibility study (1994) Schwanhäuser concluded that the planned underground main station with 8 platform tracks matches just with the given operations program, but recommended not to exclude in future the possibility to extend the number of platform track to 10, because a deficient operations quality would be expected in case of a larger variation of the train intervals at arrival. Based on the results of his second more extended study (1997) he concluded that the planned main station Stuttgart with 8 platform tracks would cope with an increased frequency of 38 trains/h and is "optimally designed" (1997, p. 55/56). This assertion is in conflict not only with the results of his previous feasibility study (1994), but also with the reported delay probabilities at most of the platform tracks (up to 17%), which are much higher than the tolerated maximum of 5% for satisfactory operations quality according to the standard of DB Netz (Tab. 5). Schwanhäuser (1997) played down the discrepancy between the estimated "optimal" quality of operations for timetabling (Tab. 10) and the obviously deficient quality for train operations on the platform tracks (Tab. 11) by asserting that the theoretical capacity shortage of the tracks #5-6 could be solved in future by flexible use of the other platform tracks and double occupation of platform track sections through short trains that enable smaller minimum headway times.

The recent introduction of four levels and new indicators for the evaluation of the operations quality by DB Netz (2011) is based on the estimated decrease and increase, respectively, of the mean inserted train delay between the entry and the arrival at the planned new main station and at the exit of the network. As the probability and size of the inserted primary delay (Tab.13) was not validated for the network in question and rather small in comparison to the used running and dwell time margins it is doubtful, whether the simulation model output represents well the expected mean delays/train in practice. Instead of the current indicator of mean delay/train, the estimated mean and standard deviation of the delay per delayed train, disaggregated into initial, original and consecutive delays, together with the percentage of the delayed trains with a delay > 60 sec and the mean speed of all trains would represent much better the robustness of operations against disturbances and effectiveness of the timetable and operations.

## **6. Conclusions**

The sophisticated analytical and stochastic microsimulation methods for capacity estimation of railway networks and in particular of stations with multiple platform tracks developed in Germany and applied for the project Stuttgart 21 comprise feasibility and robustness analyses of future timetables and of the planned new infrastructure and stations. However, the standards of the incumbent train operator and infrastructure manager Deutsche Bahn for the design of the (minimum) dwell time at stations, as well as for the estimation and simulation of train delay distributions are insufficiently validated based on empirical data. The synchronous microsimulation model applied for the network in Stuttgart or else, would need to be calibrated in order to verify its reliability and accuracy with respect to the specific operations program, infrastructure, signaling and safety systems, rolling stock dynamics, and dispatching algorithms. An impartial standard definition for operations quality does still not exist and should reflect not only the expected train delays, but also the operating speed, train occupancy, track occupation, and the volume, travel time and distance of the passengers in the network.

Accurate statistical analyses of the distribution of the revealed train dwell times and recovery times from primary delays as function of the route and station design, train characteristics, timetable, train load and track occupancy are necessary to demonstrate the evidence of the distributions and parameters used for timetable design, simulation of train operations and estimation of consecutive and total delays in complex heavily occupied networks.

Further research is recommended on the governance and evolution of transport flow forecasts, planning and construction periods, operations performance, and the analysis of cost and benefits of major railway investment projects.

## **References**

Deutsche Bahn (2014), Geschäftsbericht, <http://ib2014.deutschebahn.com/ib2014-de/interaktiver-kennzahlenvergleich/10-jahres-uebersicht.html>

DB Netz (1999), Richtlinie Fahrwegkapazität Zeitverbrauch bei Nutzung der Fahrwegkapazität (in German), 405.0102, Appendix 3

- DB Netz (2011), Stresstest Stuttgart 21 Fahrplanrobustheitsprüfung, 30.06.2011
- Eisenbahn-Bundesamt (2005), Planfeststellungsbeschluss für den Umbau des Bahnknotens Stuttgart „Projekt Stuttgart 21“ Erläuterungsbericht (in German), Anlage 1, Teil 1, 28.01.2005
- Fischer, K., Hertel, G. (1990), Bedienungsprozesse im Transportwesen (in German), Berlin: Transpress
- Flyvbjerg, B., Bruzelius, N., van Wee, B. (2008), Comparison of Capital Costs per Route-Kilometre in Urban Rail. *European Journal of Transport and Infrastructure Research*, 1, 17-30
- Flyvbjerg, B. 2007 'Policy and planning for large infrastructural projects: problems, causes and cures', *Environment and Planning B: Planning and Design*, 34, 578-597
- Heimerl, G. (1994), Projekt Stuttgart 21 Machbarkeitsstudie. Verkehrliche und betriebliche Untersuchung, betriebs- und gesamtwirtschaftliche Bewertung. Ergebnis der Fachgruppe 2 (in German), Verkehrswissenschaftliches Institut an der Universität Stuttgart
- Heimerl, G. (1997a), Stuttgart 21 Ergänzende betriebliche Untersuchungen. Teil 1: Integraler Taktfahrplan (ITF) und gewähltes Betriebsprogramm für Stuttgart 21 (in German), Verkehrswissenschaftliches Institut an der Universität Stuttgart
- Heimerl, G. (1997b), Stuttgart 21 Ergänzende betriebliche Untersuchungen. Teil 2: Kapazitätsreserven beim geplanten Stuttgarter Hauptbahnhof sowie beim Betriebskonzept Stuttgart 21 (in German), Verkehrswissenschaftliches Institut an der Universität Stuttgart
- Hertel, G. (1986), Analytische Modellierung und formelmäßige Behandlung von Standard-Bedienungssystemen mit störanfälligen Kanälen, PhD thesis, Hochschule für Verkehrswesen, Dresden
- Landeszentrale für politische Bildung (2011), Stuttgart 21, Stresstest [http://www.lpb-bw.de/stresstest\\_stuttgart21.html](http://www.lpb-bw.de/stresstest_stuttgart21.html)
- Lindner, T. (2011), Application of the analytical UIC 406 compression method for evaluating line and station capacity, *Journal of Rail Transport Planning & Management*, 1(1), 49-57
- Rail Management Consultants, <http://www.rmcon.de/railsys-en/railsys-suite/>
- Schwanhäußer, W. (1974), Die Bemessung der Pufferzeiten im Fahrplangefüge der Eisenbahn, PhD thesis, RWTH Aachen
- Schwanhäußer, W. (1994), The Status of German Railway Operations Management in Research and Practice, *Transportation Research Part A*, 28(6), 495-500
- Schwanhäußer, W. (1994), Kapazität des geplanten Bahnhofes Stuttgart Hbf Tief im Vergleich mit dem bestehenden Kopfbahnhof. Project Stuttgart 21 (in German), Rheinisch-Westfälische Technische Hochschule Aachen, Verkehrswissenschaftliches Institut
- Schwanhäußer, W. (1997), Stuttgart 21 Ergänzende betriebliche Untersuchungen . Teil III: Leistungsverhalten und Bemessung des geplanten Stuttgarter Hauptbahnhofes und seiner Zulaufstrecken (in German), Verkehrswissenschaftliches Institut der RWTH Aachen

SMA und Partner AG (2011), Audit zur Betriebsqualitätsüberprüfung Stuttgart 21, Schlussbericht  
21.07.2011

Spiegel Online International, 'Stuttgart 21': A Four Billion Euro Makeover, August 13, 2010,  
<http://www.spiegel.de/international/germany/stuttgart-21-a-four-billion-euro-makeover-a-710388.html>

Spiegel Online International, The World from Berlin: In Stuttgart, 'No Compromise Is Possible',  
October 7, 2010, <http://www.spiegel.de/international/germany/the-world-from-berlin-in-stuttgart-no-compromise-is-possible-a-721802.html>

Spiegel Online International, Cost Overruns in Stuttgart: German Rail Admits Station Was a Mistake,  
February 28, 2013, <http://www.spiegel.de/international/germany/german-railway-admits-massive-stuttgart-station-was-a-mistake-a-886099.html>,

Spiegel Online International, Gutachten zum Bahnhofsumbau: Stuttgart 21 besteht Stresstest,, July  
21, 2011 <http://www.spiegel.de/politik/deutschland/gutachten-zum-bahnhofsumbau-stuttgart-21-besteht-stresstest-a-775736.html>

Spiegel Online International, Stuttgart 21 May Yet Fail: Berlin Alarmed at Surging Cost of Rail Project,  
January 28, 2013

Wakob, H. (1995), Ableitung eines generellen Wartemodells zur Ermittlung der planmäßigen  
Wartezeiten im Eisenbahnbetrieb unter besonderer Berücksichtigung der Aspekte Leistungsfähigkeit  
und Anlagenbelastung, PhD thesis, Veröffentlichungen des verkehrswissenschaftlichen Instituts  
RWTH Aachen,36, <http://www.via.rwth-aachen.de/software/alfa.html>

Wendler, E. (2007), The scheduled waiting time on railway lines, Transportation Research Part B,  
41(2), 148-158