

Future Relics

2.

“Design for Destruction”

Master Thesis: BT Report

Luca Parlangeli

North Sea: Landscapes of Coexistence
Transitional Territories Studio 2019-2020

Future Relics

*“About Doel’s ‘de-polderisation’ and
destruction in the Post-Anthropocene era”*

Building Technology Report

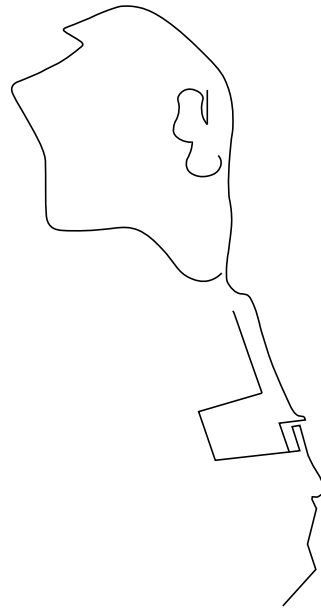

Luca Parlangeli

North Sea: Landscapes of Coexistence
Transitional Territories Studio 2019-2020

Index

I. Abstract

II. Building Technology

a. Programme

b. Structure

c. Climate

d. Facade

e. Energy and Water

III. Appendix

a. Floor plans

b. Elevations and Sections

IV. Sources & Bibliography

Research Report

I.

Abstract

I. Abstract

The research brought out different temporal frames for delineating the project: from the intersections between the socio-environmental emergencies and the status quo, three possible scenarios of interventions were thus depicted, always keeping the Anthropocene as a general framework for defining the conceptual and spatio-temporal coordinates of the project.

The project starts with a regional strategic and energetic plan which foresees the “depolderization” of the area, its transformation into a controlled tidal zone for soil and water recovery, and the simultaneous expansion of the Saeftinghe natural reserve. The area is in fact both a “gateway” to Antwerp and a buffer between the port infrastructure and the rural environment. The ‘post-nuclear scenario’, would be starting after 2025, when the power plant is (supposed to be) closed, the reactors dismantled, and the area remediated. In such picture, the cooling towers can remain as landmark and monument of the industrial past of the place or be re-converted into a seed vault/frozen zoo, while the rest can be demolished. Unfortunately, no rebirth future can be imagined for the town of Doel as it is a small country town which has lost both its agricultural vocation and its nuclear function over time. The hamlet can instead be turned into a memorial or “relic” city through the act of surrounding it with a protective wall. The walkable wall will then be a reminder of the stubbornness of Doel’s inhabitants, who resisted to flooding in the remote past, while recently survived the pressure of an infrastructural economic force such as the Port of Antwerp.

The second timeframe could be define as the ‘depolderization project’, which would entail the transformation of the polder into a controlled tidal area while merging it with the natural reserve, whereas the dock, the dike, the town and the nuclear power plant would remain untouched by water as they would be either structurally protected or located in an advantageous elevated position.

Lastly, the third modification in time takes into account the possibility of apocalypse and failure of this society in fighting climate change. The final conclusions and assumptions of the project are therefore rather speculative: the design tries to depict the future scenarios in case of failure of humankind in the creation of a more sustainable and eco-based built environment. Even in this scenario the system of buildings would still stand as a “sanctuary”, symbol of the catastrophic past but also reservoir for the possible rebirth of society.

The architecture imagined for the Doel site is therefore physically linked to the water-level-rise process. When/if the level of the Scheldt rises above 2 meters, the whole area will be flooded and any human survival unlikely. In these circumstances, the water will trigger the self-destruction of the facility, spreading the seeds contained in the vault all over the area and thus favouring the rebirth of nature in unpredictable climatic conditions. In the end, the Seed Vault/Frozen Zoo constitutes, like Doel, the nemesis of the Port but, also like Doel, will eventually evolve into a ruin in case of loss in the fight against anthropization, pollution and climate change.



Noah's Ark
Author: Simon de Myle
Year: 1570

BT Report

II.

Building Technology

a. Programme

The architecture planned consists primarily of a “*knowledge ark*” with laboratories and academic-related spaces, a space where knowledge is collected (under any form) in order to be preserved and passed to future generations. Thanks to its advantageous position near Doel and Antwerp, the facility can exploit not only the world-level port infrastructure for an optimized logistic (coldchain), but also the proximity of the natural reserve and the former agricultural vocation of the area.

To synthesise, the volumes which compose the whole apparatus are: the seed vault, situated inside the remained cooling tower, the long strip building for laboratories and public facilities, the panoramic tower and the underground museum placed inside the footprint of the dismantled cooling tower.

The repository building, which would be installed inside the existing cooling tower, is both a *seed vault* and a *frozen zoo* for the conservation of species through cryopreservation technique (liquid nitrogen), but most importantly is an architectural object designed to resist or accommodate temporal and territorial transformations for guaranteeing a possible rebirth of both nature and culture.

The public part of the lab-scape building includes a canteen, a library, offices, classrooms and leisure spaces. The “*museum of extinction*” sits underground, in the former footprint of one of the cooling towers and it is covered by an eclipsed circular roof which hosts underwater solar panels. Finally, the obelisk is connected to both the lab building and the vault and it offers the possibility to access its top floor for a panoramic view of all Flanders.

Many factors contributes to the high level of complexity of the building, for example the diversity of users and of the timeframes of use, the level of accessibility and privacy, the different requirements for the laboratories, and finally the amount of robotization and automation required for each space. Therefore, the three main criteria for a simple and efficient distribution of the programme were the material flow and users circulation directions, the gradient of privacy and accessibility of each function, and the need of natural lighting and artificial ventilation.

The lab-scape layout was chosen as the basis for the spatialization of the programme related to research, in this way the common work stations can be installed in an open space for a more pleasant work environment, where both light and nature can “enter” the room. The dark rooms and the specific/safety labs are still compartmentalised and mostly planned underground where the minimum light and maximum privacy level are required.





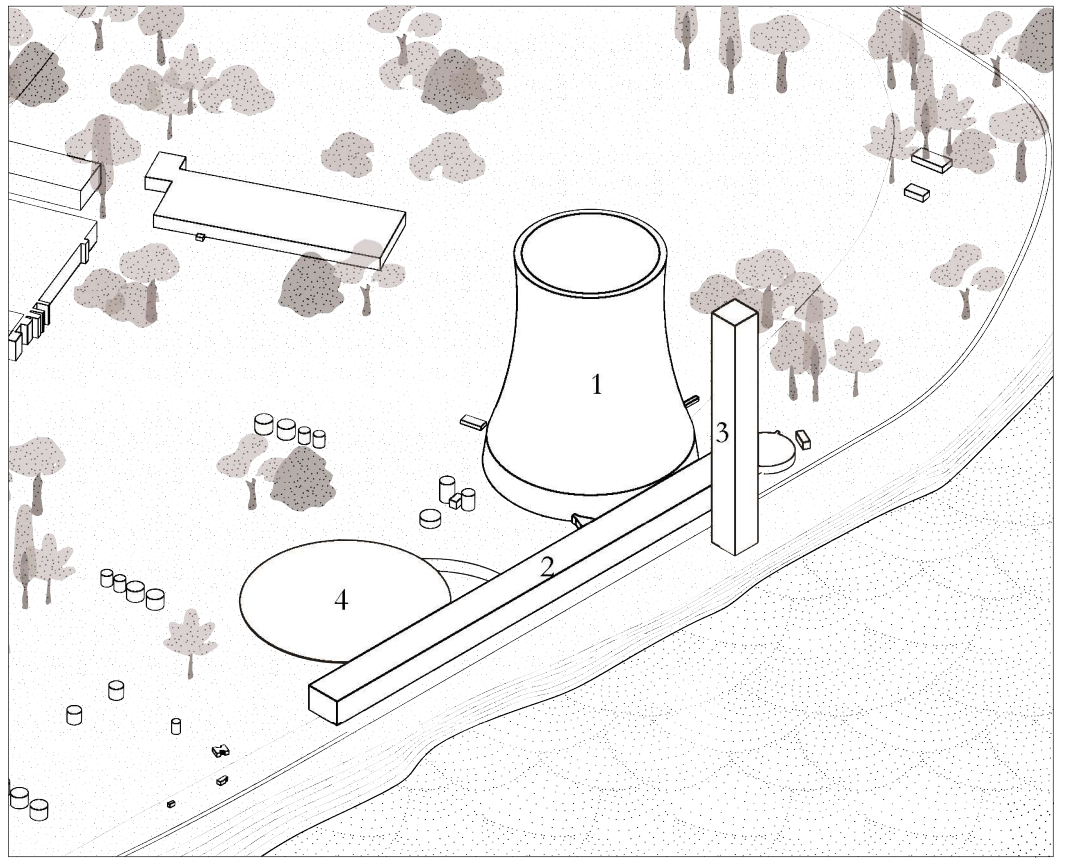

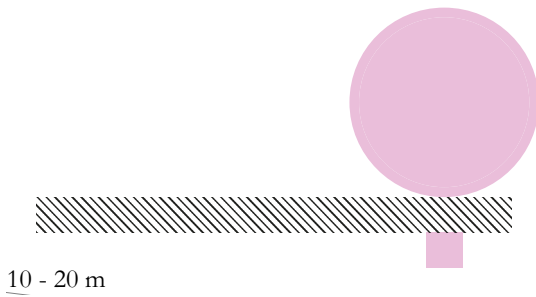
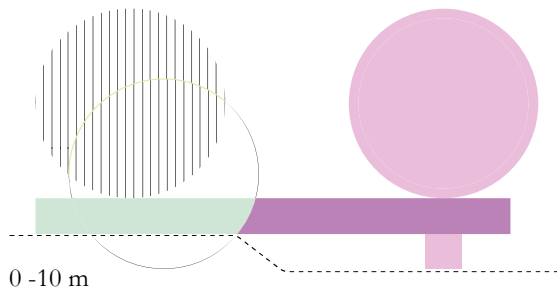
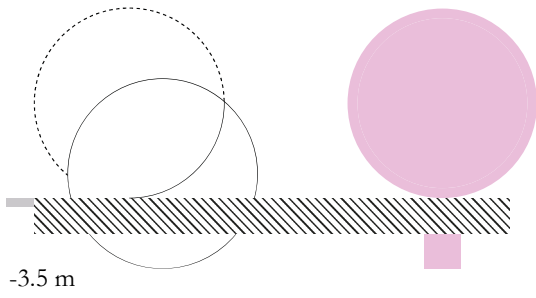
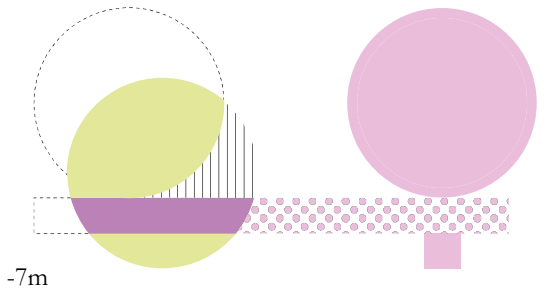
The Project

1. Seed Vault/Frozen Zoo
2. Lab-scape Facility
3. Obelisk
4. Eclipsed Solar Pool





Programme

-  Dark Rooms and Archive
-  Laboratories
-  Seed Vault/Frozen Zoo
-  Offices, Classrooms, Canteen, Library
-  Underground Plaza and Museum
-  Underground Parking and Technical Storey

Complexity of the Building

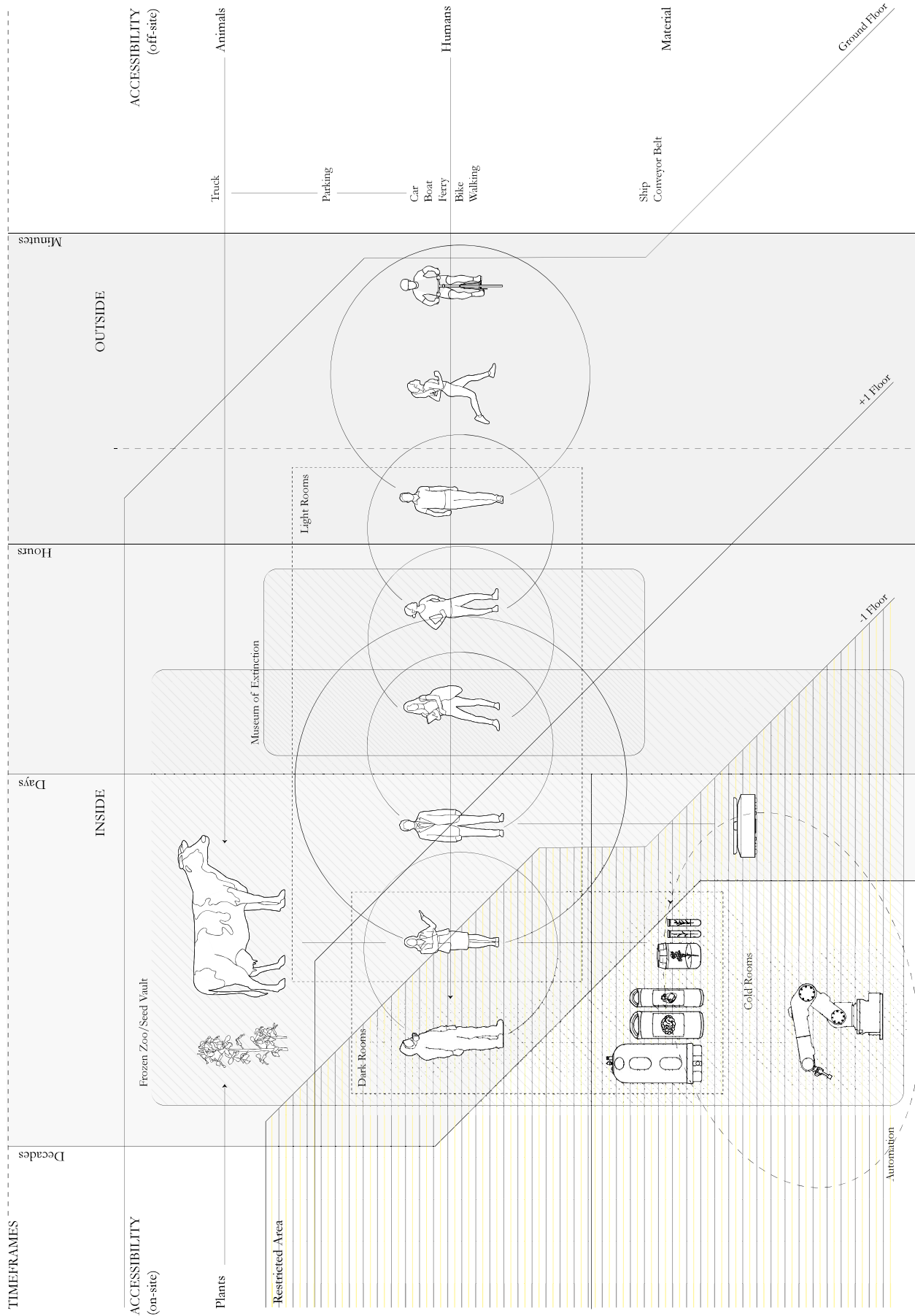

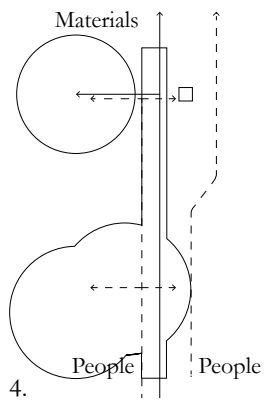
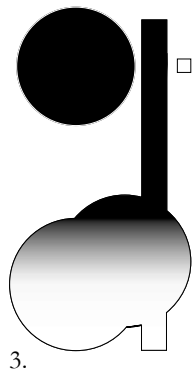
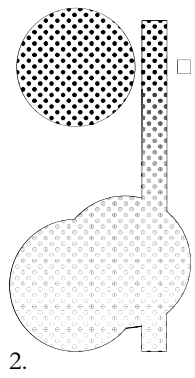
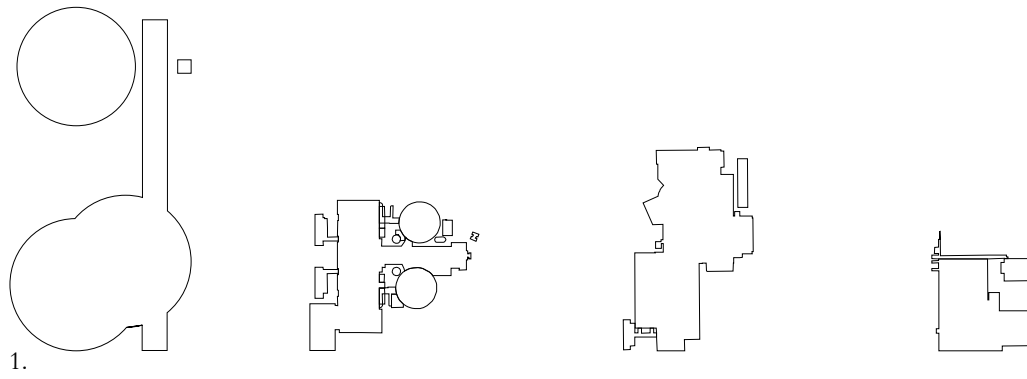

Concept

1. Scale Comparison with Doel Nuclear Reactors
2. Gradient of Privacy
3. Need of Natural Lighting
4. Efficient Material Flow and Circulation

Seed Vault

7%	Installations
46%	Labs
12%	Offices
7%	Seed Vault
5%	Glasshouse
23%	Public Areas

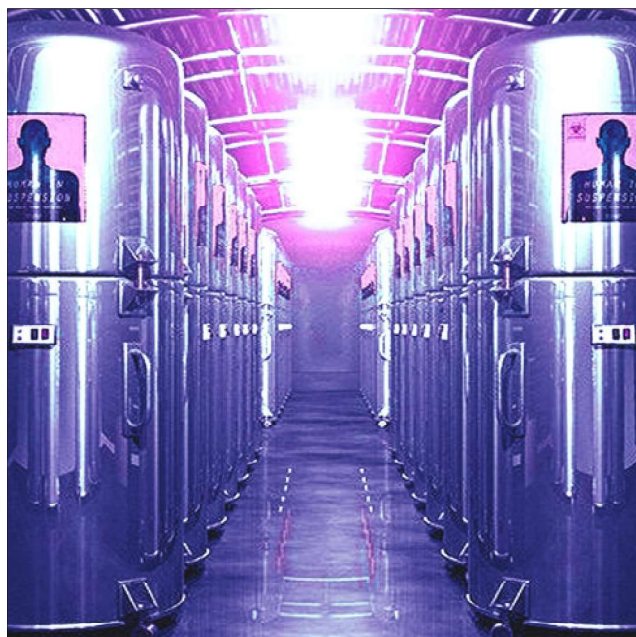

1.

Frozen Zoo

65%	Frozen Zoo (-1 Floor)
35%	Public Areas



2.

Seed Vault/Frozen Zoo Programme Layout

1. Occupation of space for San Diego Frozen Zoo
2. Occupation of space for Millennium Seed Bank UK

Global Crop Diversity Trust*International non-profit organization*

+

Nordic Genetic Resource Center*Plant, farm animal and forest conservation, gene resource guardian, and sustainable use organization*

+

Nordic Council of Ministers*Intergovernmental forum*

+

Bill & Melinda Gates Foundation*Private charitable foundation*

+

FAO, CGIAR, ITPGRFA*International Councils*

The Seed Vault is a facility for the conservation of plants' genetic material by in vitro storage, dormant cuttings, or cryopreservation, it works all in all like a bank and its purpose is to preserve a varieties of seeds in case they are destroyed by either man or natural events and assistance in case of need for future harvests and other agricultural interests. The conservation of seeds will then contribute to the improvement of current crops by crossbreeding them. The Frozen zoo is instead a biorepository which preserves semen, embryos, oocytes, somatic cells, DNA and other types of biomaterial such as blood or organs through the technique of cryo-conservation. The aim of such facility is to guarantee survival against changes in production conditions, while conducting genomic research and experiments against diseases.

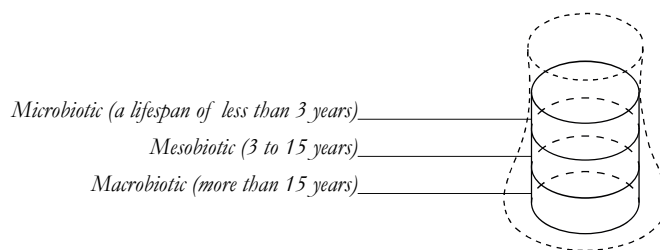

1.

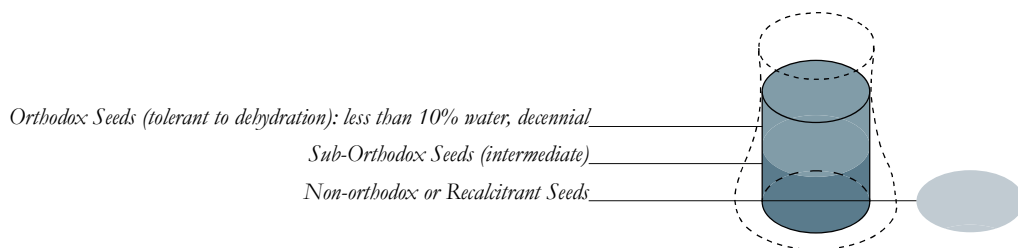

2.

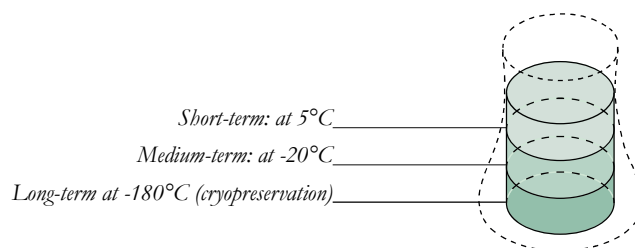

3.

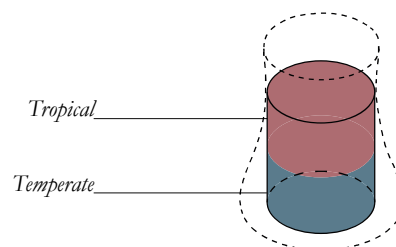

4.



5.

Criteria for Biobanking Layout

- 1. Lifespan
- 2. Dehydration
- 3. Ciclicity
- 4. Temperature
- 5. Geographical Location

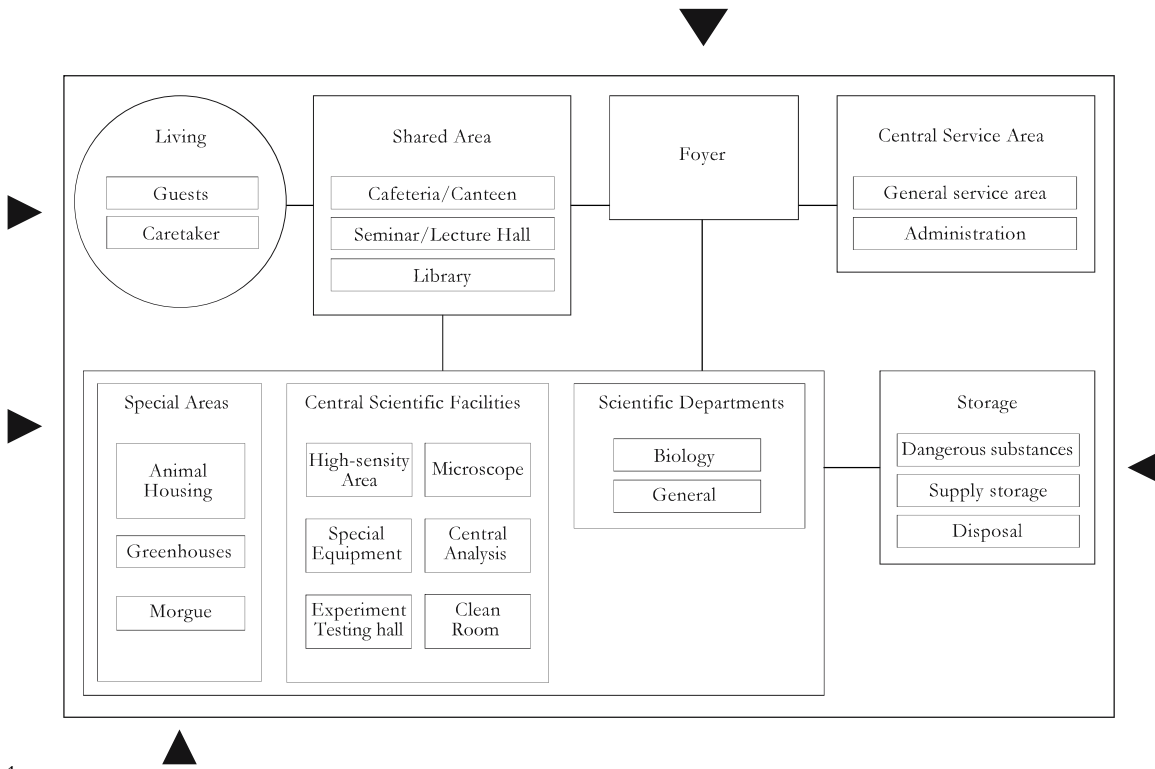

1.

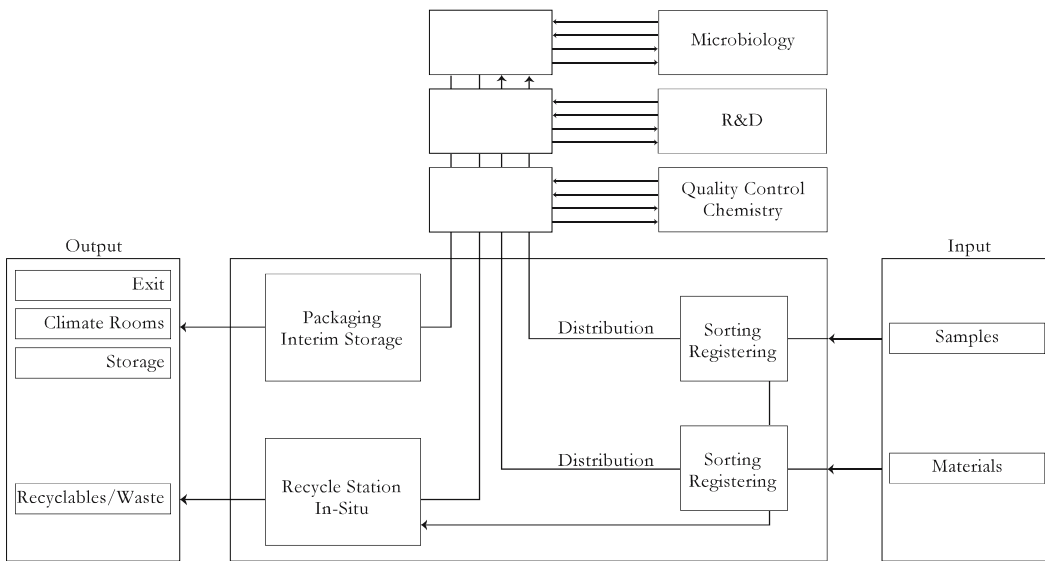

2.

“Designing research buildings is combining spaces with different requirements.”

Laboratories regardless of their specific use, have many similar health and safety requirements that were taken into consideration during the design process. Laboratory buildings are frequently rigidly divided in sections or compartments. In such rigid layout, great importance is given to the optimization of servant spaces, as they have to allow the most efficient circulation and flow of materials.

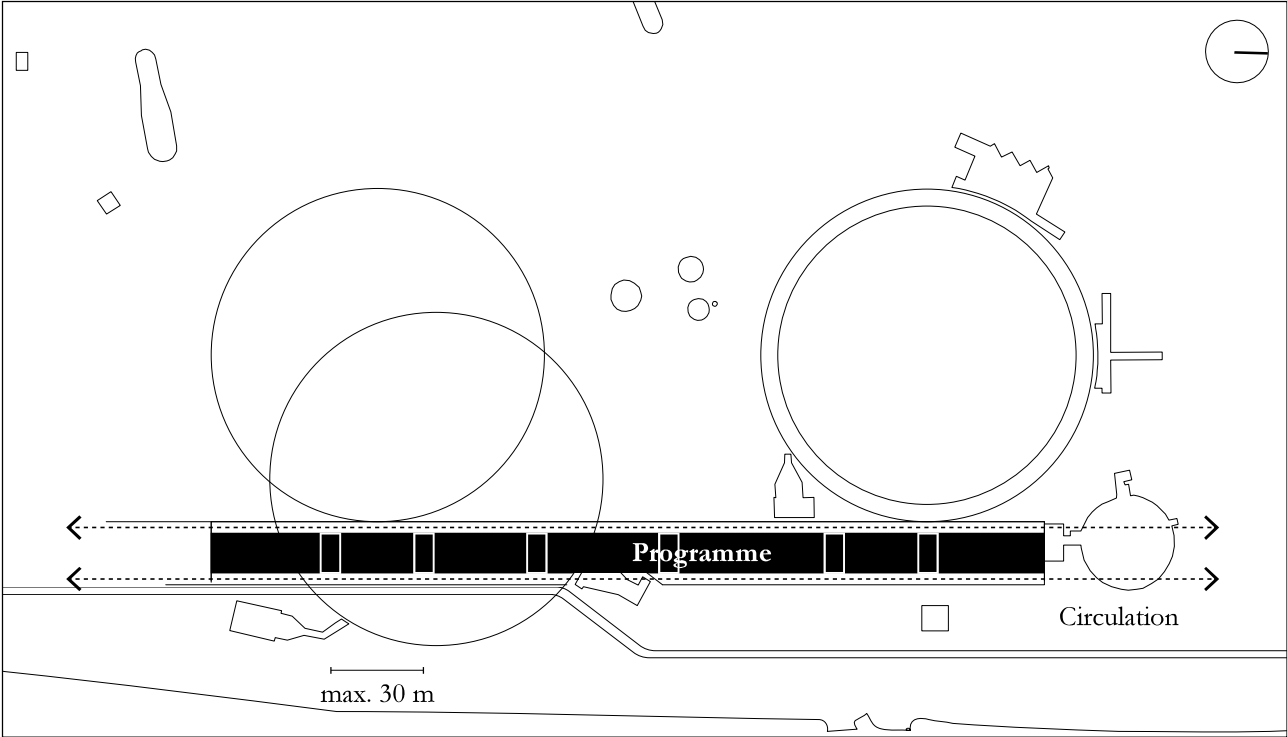

3.

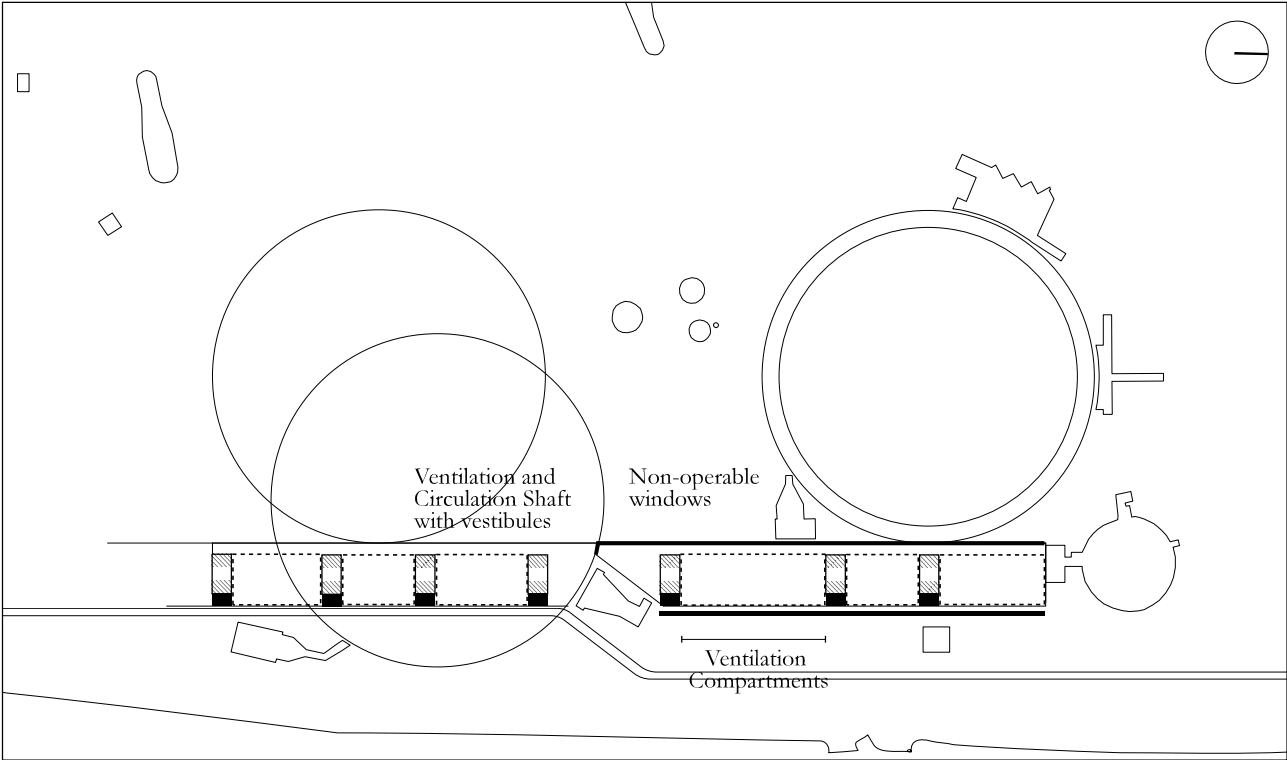

4.

Distribution of Spaces

- 1. Sectorisation
- 2. Efficient Material Flow
- 3. Circulation
- 4. Ventilation Compartments

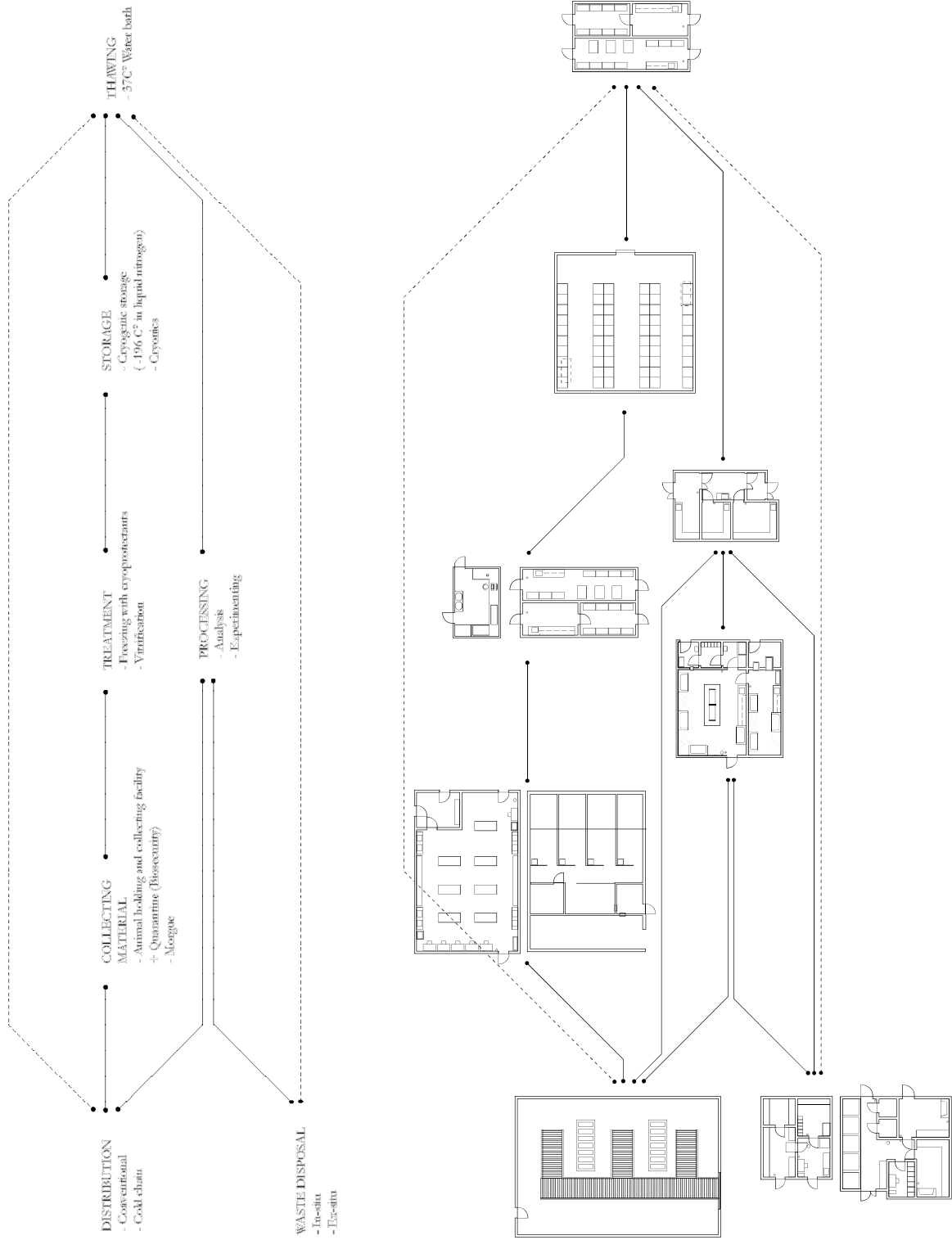

1.

Processes

1. Frozen Zoo Process
2. Seed Vault Process

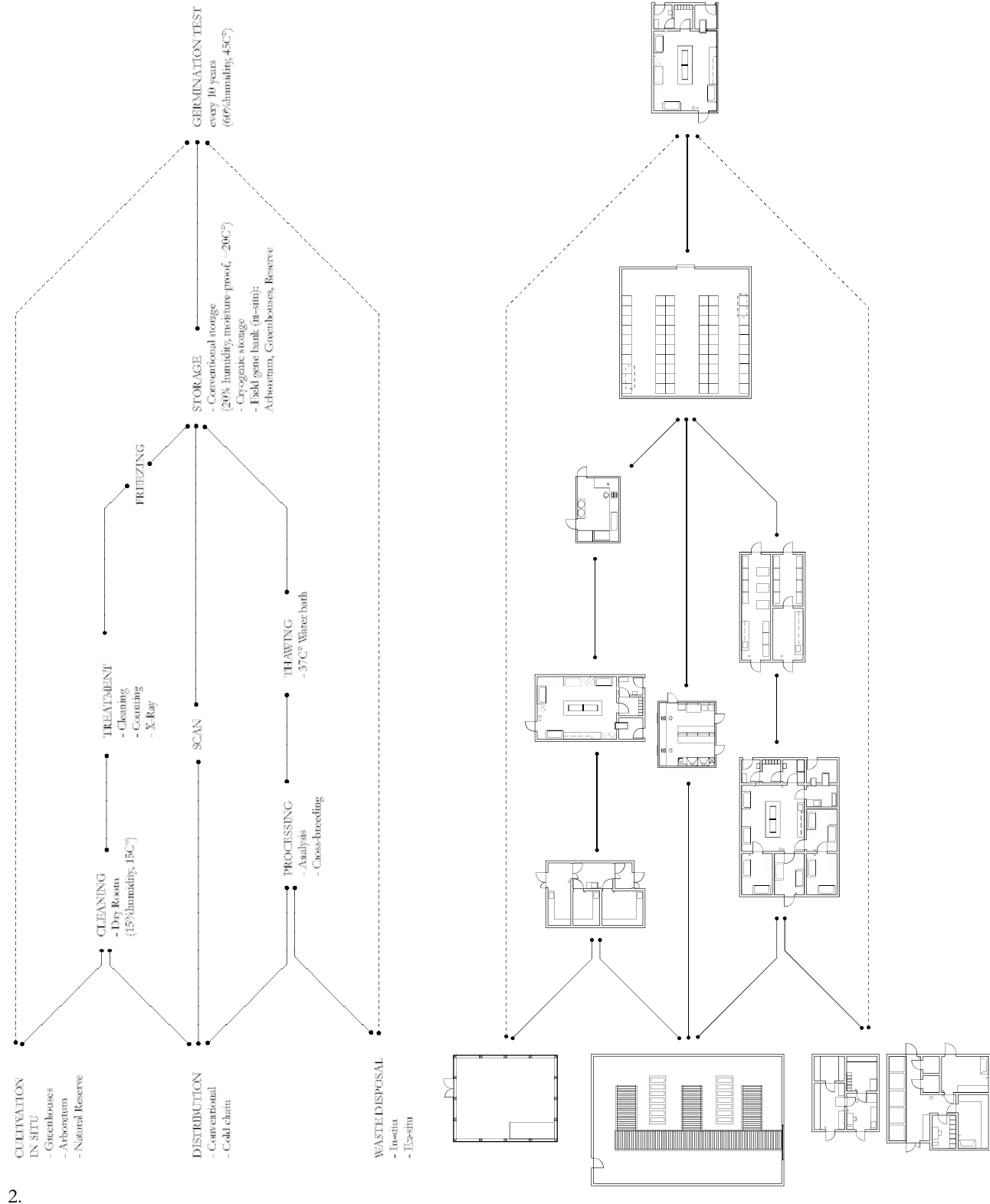

Interior Materials for Laboratories

Material	Composite ¹	Epoxy	Phenolic ²	Plastic Laminate	Polypropylene ³	Stainless Steel	Solid Wood Laminate
Chemical Resistance	Good	Good	Good	Fair	Good	Good	Fair
Cleanability	Good	Good	Good	Fair	Good	Good	Fair
Combustibility	Good	Good	Good	Good	Good	Good	Good
Conductivity Resistance	Good	Good	Good	Good	Fair	Good	Good
Durability	Fair	Good	Good	Poor	Fair	Good	Fair
Flexibility	Good	Good	Good	Best	Fair	Good	Good
Level, Flat, Smooth Surface	Good	Fair	Best	Fair	Fair	Good	Fair
Strength	Varies	Varies	Good	Varies	Poor	Good	Varies
Temperature Resistance	Good	Poor	Good	Poor	Poor	Good	Good
Vibration Control	Fair	Good	Good	Fair	Good	Good	Good
From renewable resources		No	No	No	No	No	Yes
With recycled material content		No	No	Some	No	No	Yes
With Low Embodied Energy		No	No	Yes	No	No	Yes
Low VOC emissions		No	No	No	No	Yes	Yes
Durability		Good	Good	Poor	Good	Best	Good
Refinish and Repairability		Poor	Good	Poor	Poor	Good	Good
Recyclability		Yes	Yes	No	No	Yes	Yes

1 Plastic Panels with rigid foam filler

2 Solid resin between craft paper layers

3 PVC

1. Laboratories Layout

2. Input Spaces

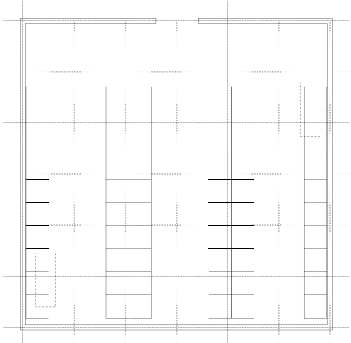
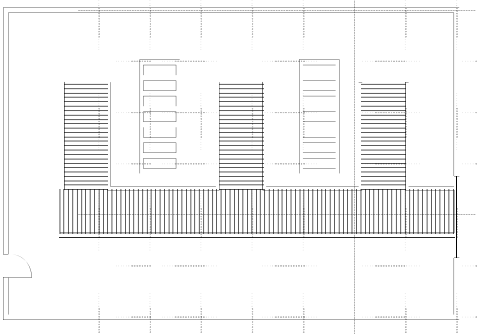
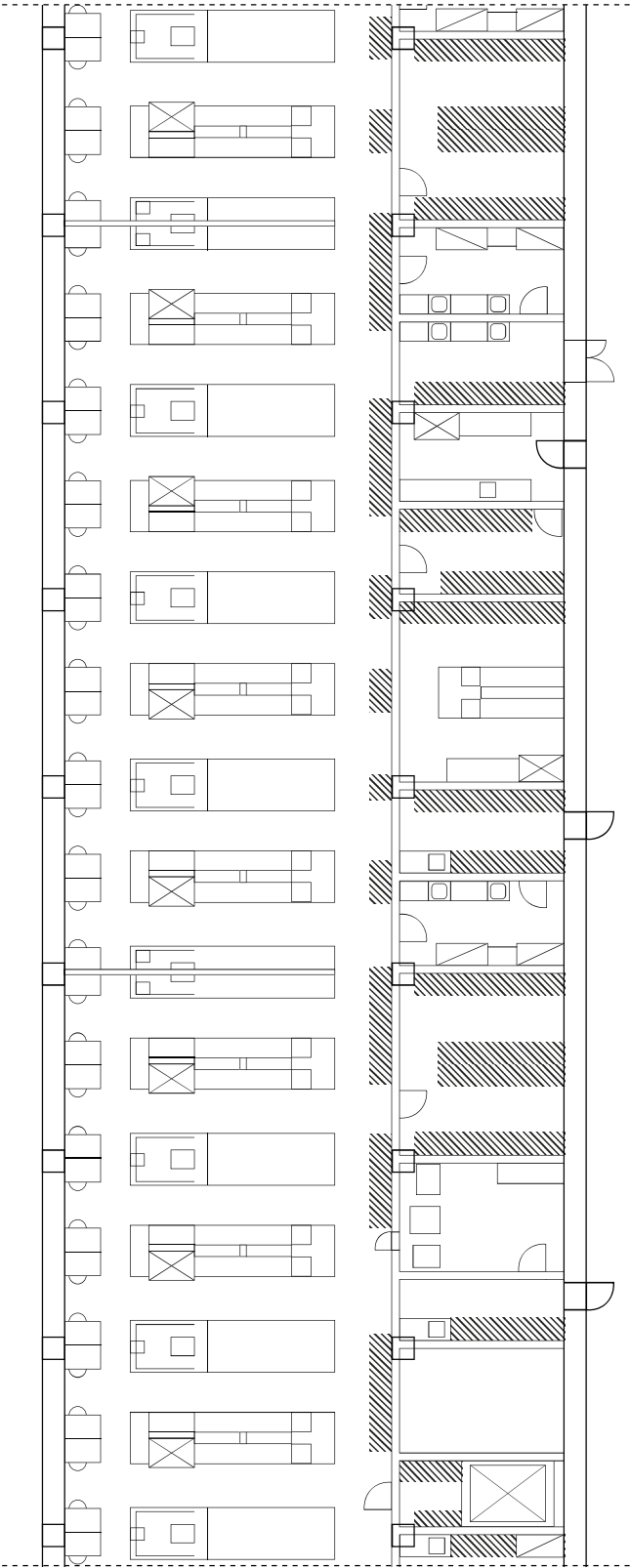

3. Collection Spaces

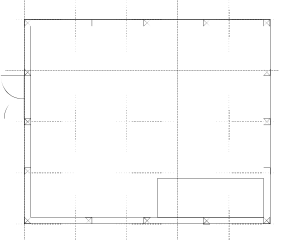
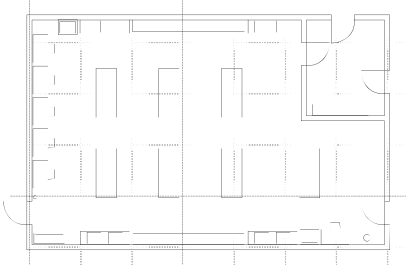
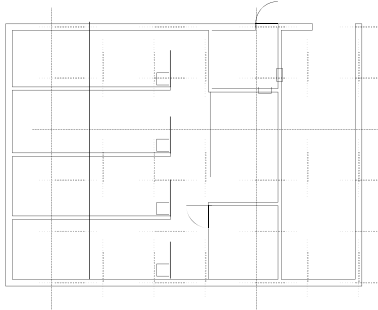

Distribution of Spaces

- 1. Labscape Typology
- 2. Automated Warehouse, Interim Storage
- 3. Animal Holding and Collection Facility, Anatomy Lab, Greenhouse

1. Common Labs

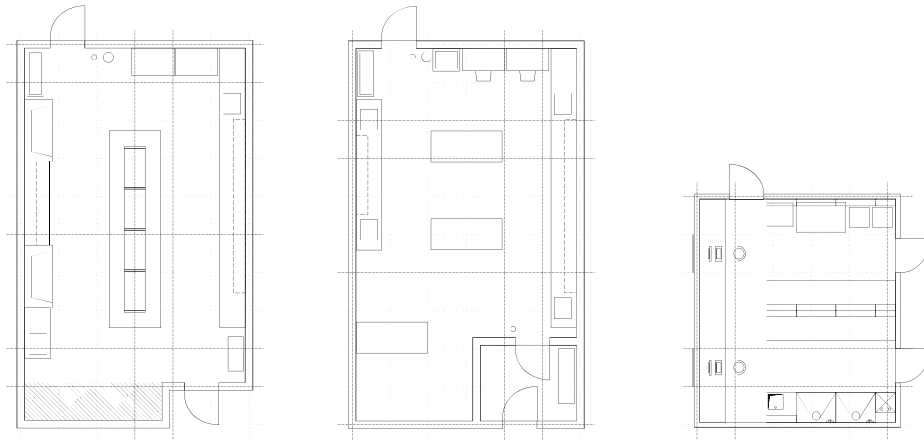

2. Specific Labs

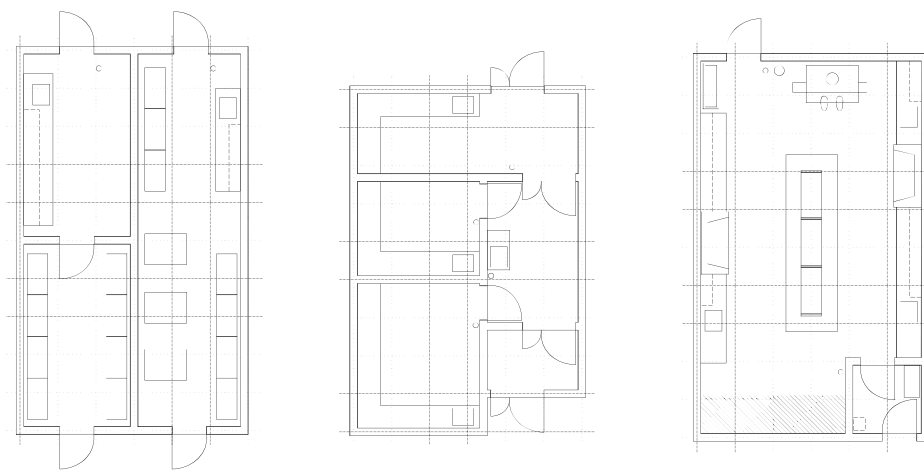

3. Safety Labs

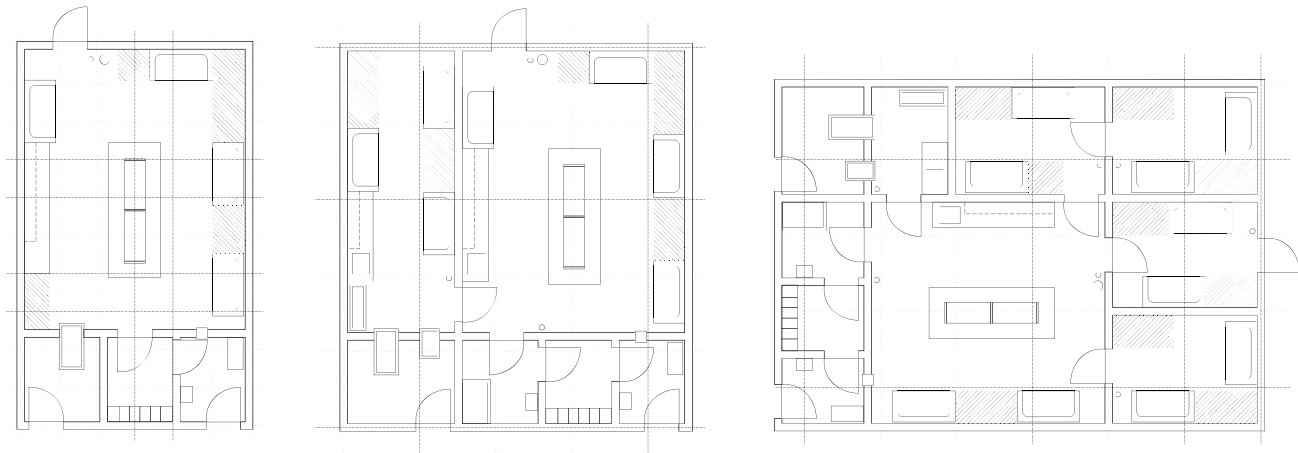

Laboratories

1. Biology, Anatomy, Chemistry
2. Temperature Controlled Lab, Cleanroom Lab Suite, High Toxicity Lab
3. Biosafety Lab, Biosafety L3 with shower, Biosafety L3 with multiple culture rooms

1. Teaching Classes

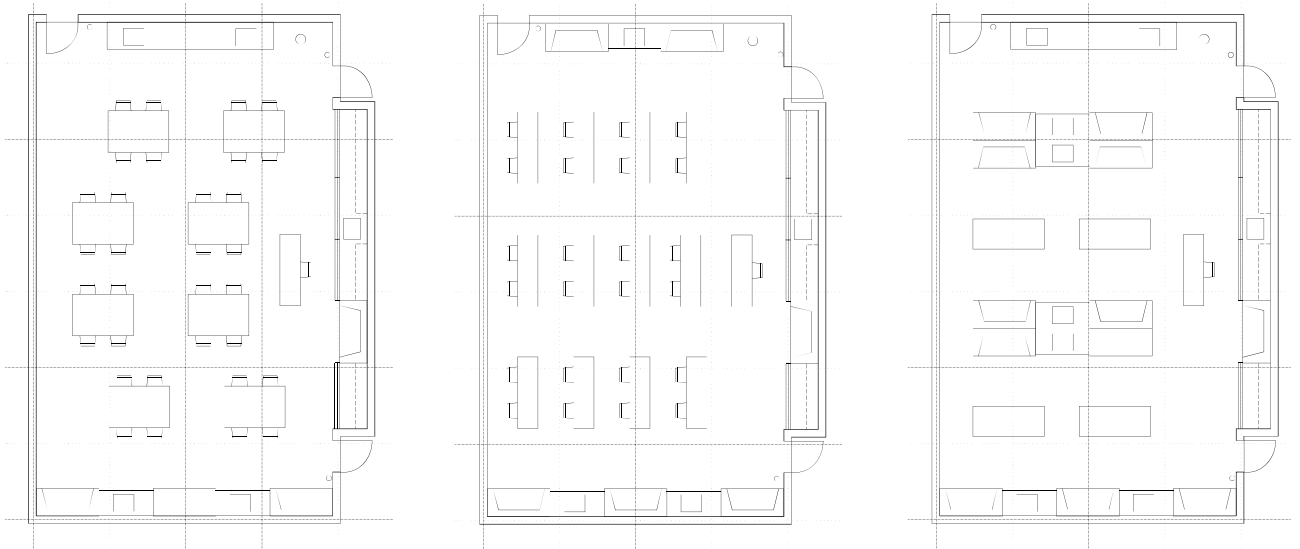

2. Output Spaces

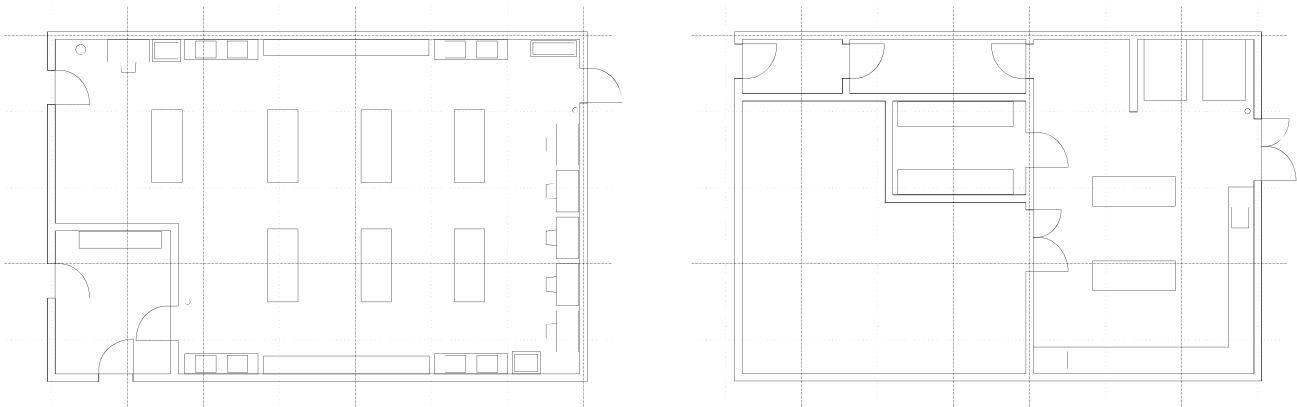

3. Output Spaces

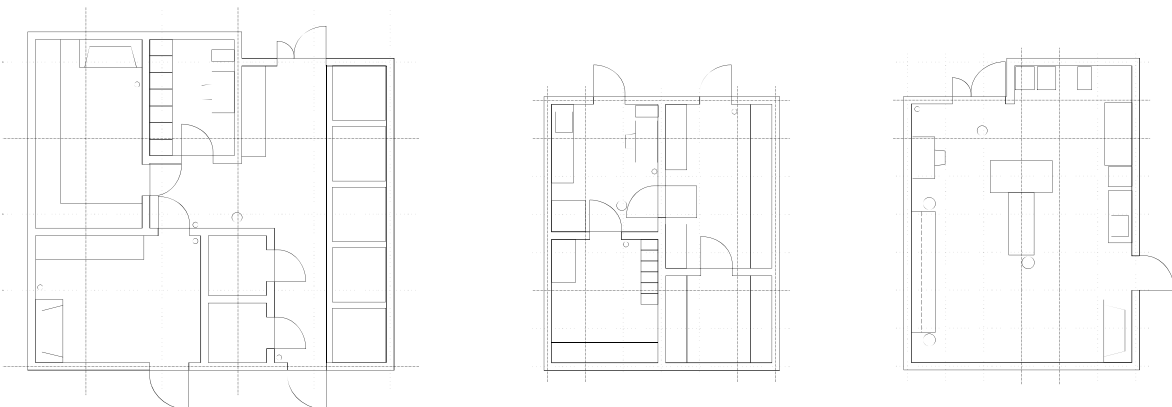

Laboratories

1. Biology Class, Chemistry Class, Organic Chemistry Class
2. Anatomy Lab, Morgue
3. Waste Treatment

b. Structure

Research Facility Structure

The structure of the project is based on the the standard grids for laboratory construction, in order to achieve the most efficient spacing of workbenches and corridors, preventing excessive spare areas and abiding to building regulations. The basic unit is 1,20 m resulting in a load-bearing grid of 7,20 m.

Concerning the heights, floor-to-floor heights range from 3.80 m to 4.10 m: offices floor height should exceed 3,00 m, while the media ceiling clearance from the floor must be more than 2,8 m.

The laboratory building structure is based on a typical grid composed of three span units: the external ones are 7,95 m x 7,8 m, the central one 9,4 m x 7,8 m. This basic grid is repeated with few exceptions along the whole length (350 m) of the building. The overall dimensions of this structure are 26 m width, 21 m height and 350 m length. The structure is relying on recycled concrete columns (1,20 m x 0,8 m), 2 curved shear walls and 8 shafts, which work both for ventilation, vertical transportation and load bearing function. The ground floor is raised by 1 m compared to the level of the dike where the building sits: with this architectural stratagem the ventilation inlets and pipes can be hidden under the building, and the gap helps isolating the structure by detaching it from the external humidity conditions.

The foundations are a mixed type: a concrete bed with piles was hipothized in order to reduce the number of vertical foundation elements necessary. Retaining walls on the size are supporting the building in the underground. The eclipsed 'water roof' of the museum is then structurally supported by 4 thick shear walls (1 m) which would make the imagined maximum span of 41 m possible. The green houses on the roof are light structures spanned by HEA beams 50 x 50 cm.

The considerable amount of concrete required can be recycled from the dismantlement of the nuclear power plant buildings (not the reactors) and mixed with debris and waste materials, mostly plastic, available at the nearby docks. As plastic can be considered the fossil material of the Anthropocene, the concrete mixture will present grains of plastic forming what Patricia Corcoran, Charles J. Moore and Kelly Jazvac call *Plastiglomerate*. This way, the material will be unique, originating on site and symbolizing somehow the past and the present of Doel.

Knowledge Ark Structure

The Biobank circular structure also lays on a mixed type foundation (piles + concrete bed) and is raised from the ground by 19,5 m thanks to the support of 8 braced tridimensional steel trusses (on the inner circumference) and 8 concrete shear walls (on the outer circumference). A circular balcony for visitors circulation hangs from the steel trusses, which are also hosting the vertical transportations systems and the pipelines.

Exploded Structural Axonometry

Greenhouses

HEA beams

Foamed Concrete Panels Facade

Technical Storey

Mezzanine and Double Heights

Curtain Wall

Ventilation Shafts

Vertical load-bearing elements

Underground Storeys

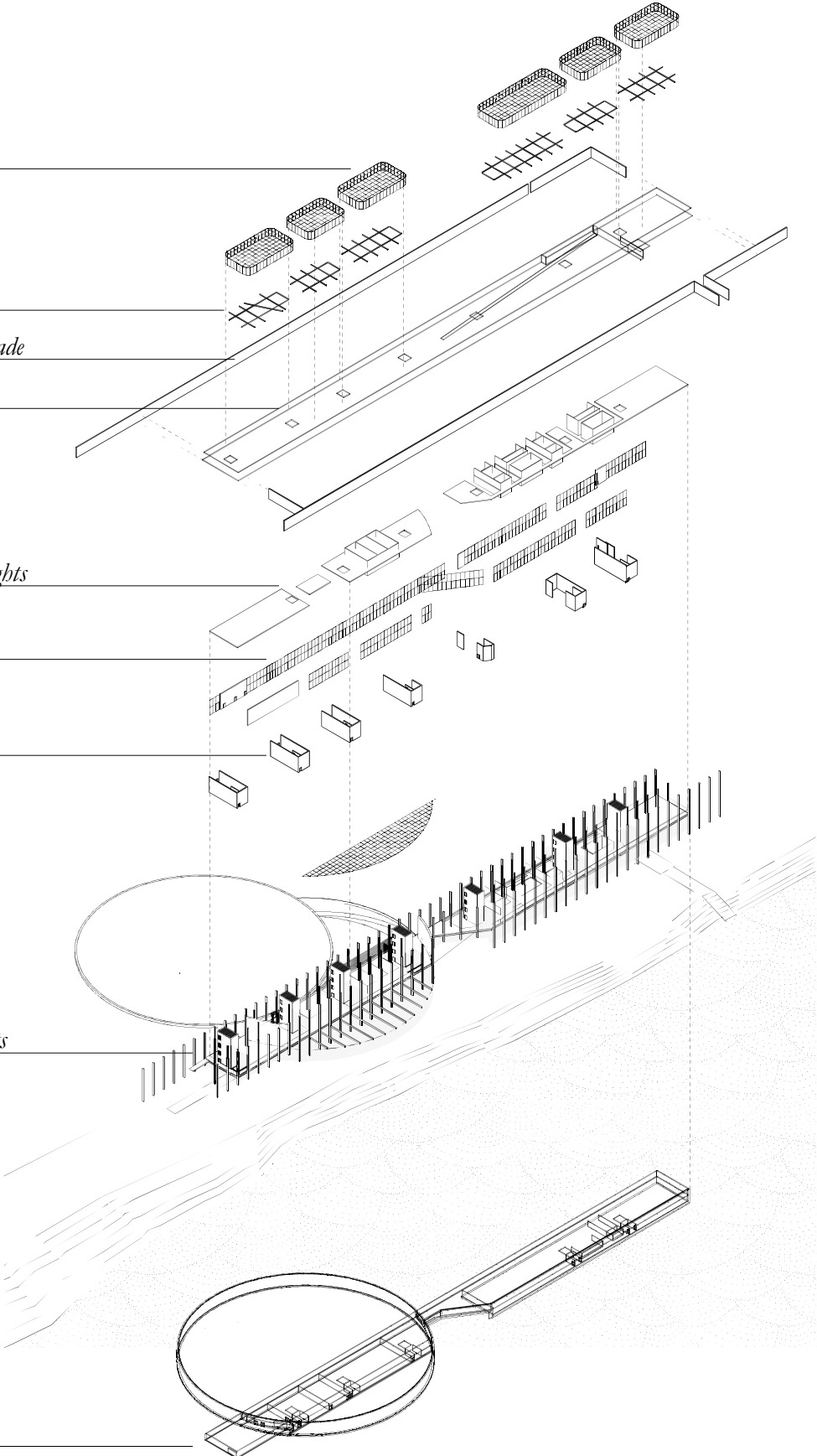

Dimensions, Grid, Modularity

(from *Guidelines for the design of a Research Building*)

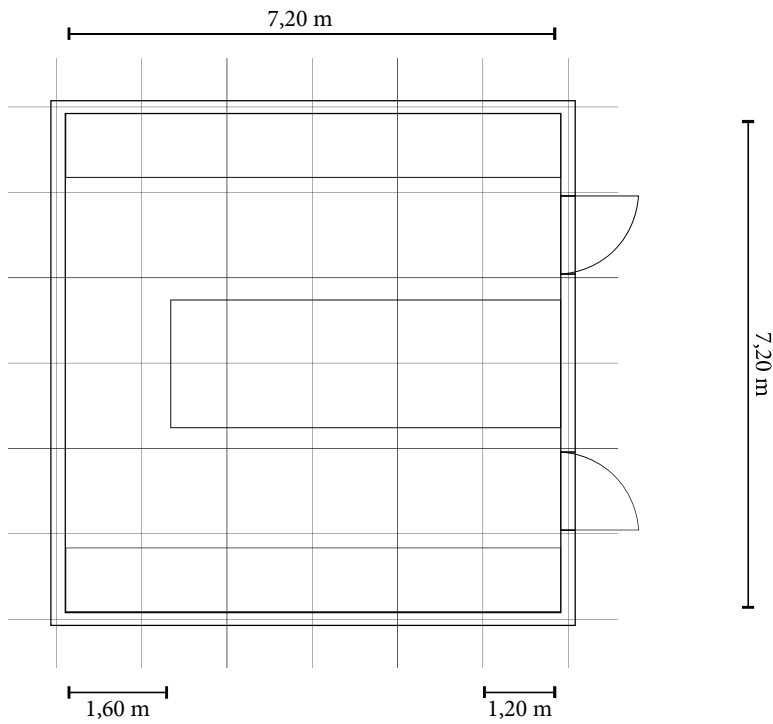

The standard grids in laboratory construction for achieving the most efficient spacing of workbenches and corridors, preventing excessive spare areas and adhering to building regulations are:

Basic Grid: 1.20m

Load-bearing grid: 7.20m

Floor-to-floor heights range from 3.80 m to 4.10 m

Media ceiling clearance from the floor: > 2.8 m

Offices floor height: > 3.00m

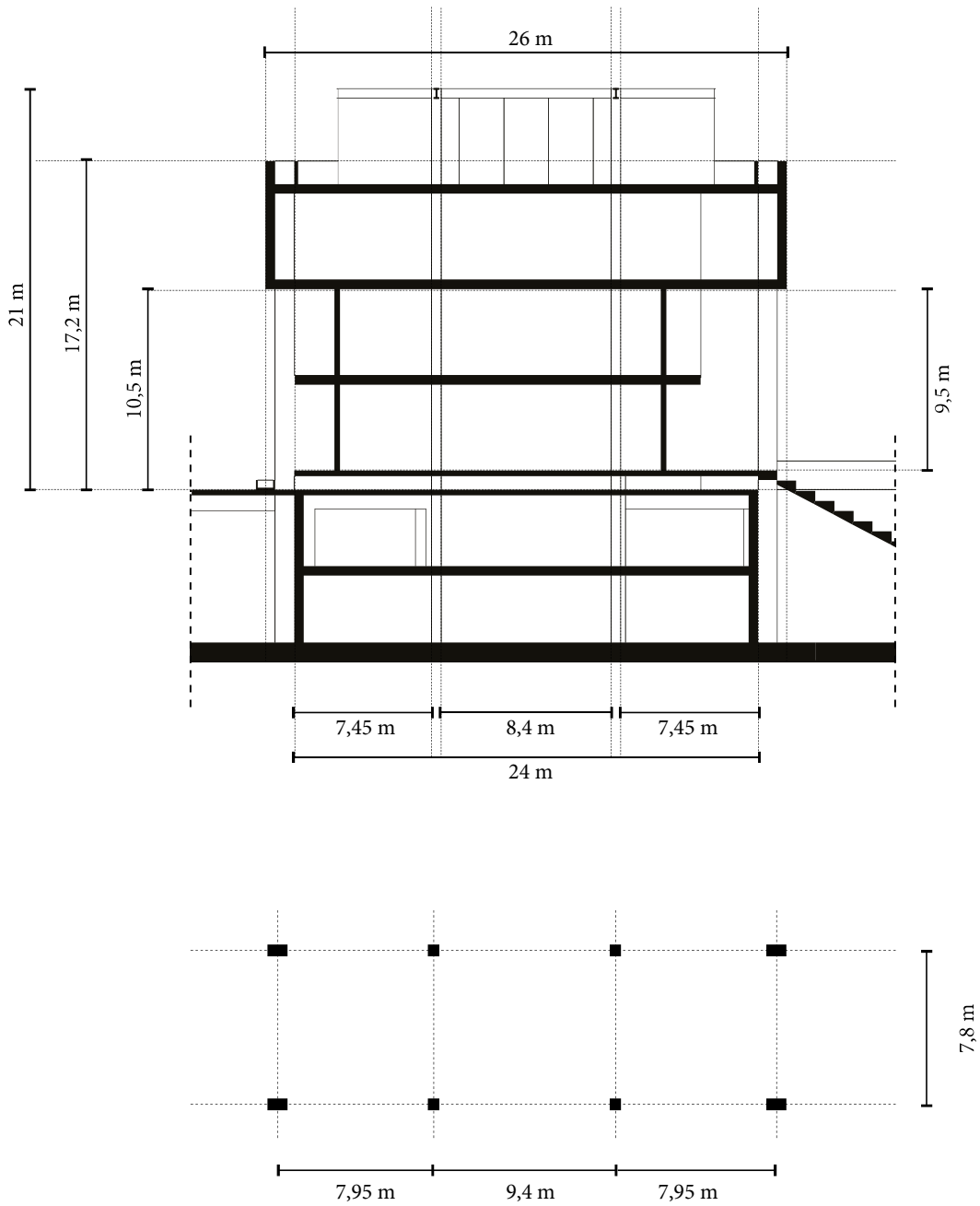

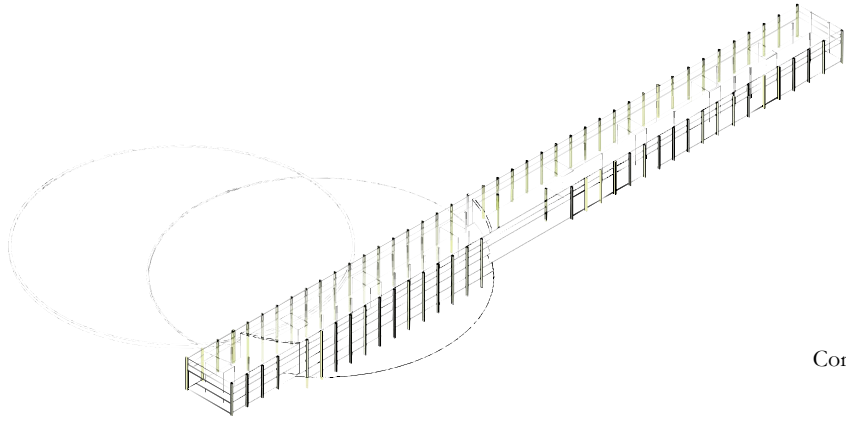

Concrete Columns

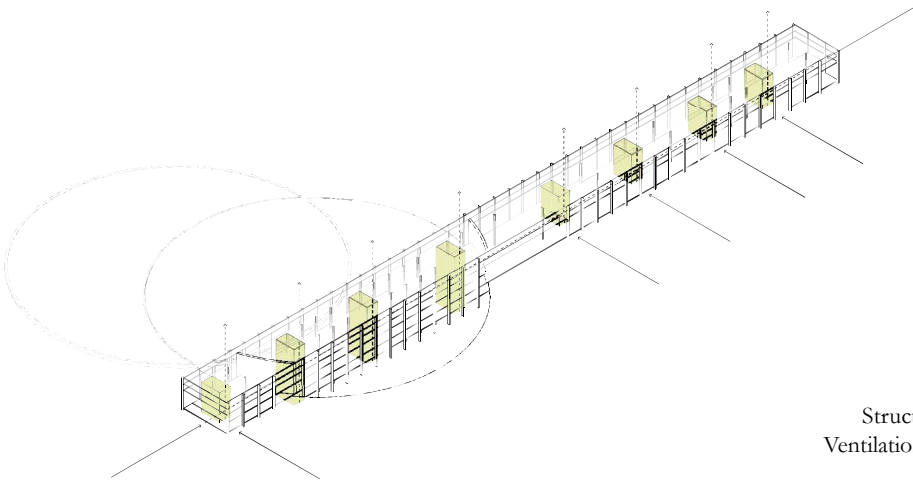

Structure and
Ventilation Shafts

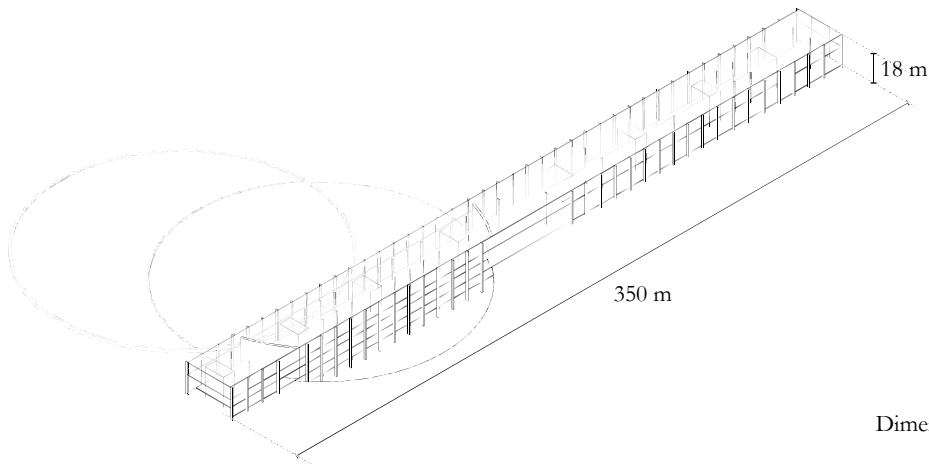

Dimensions

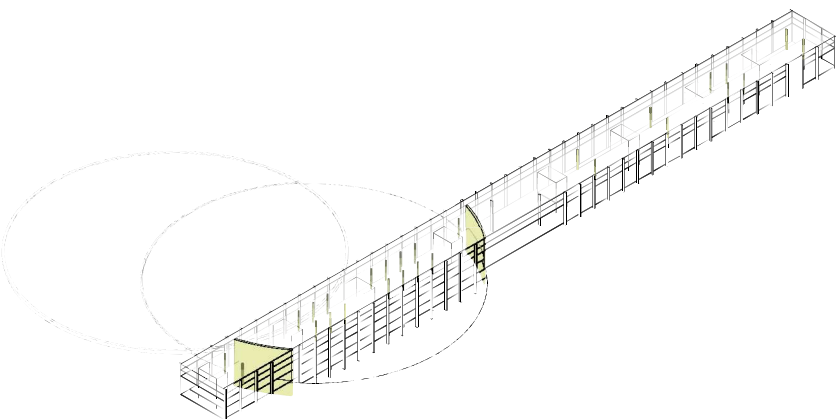

Shear walls

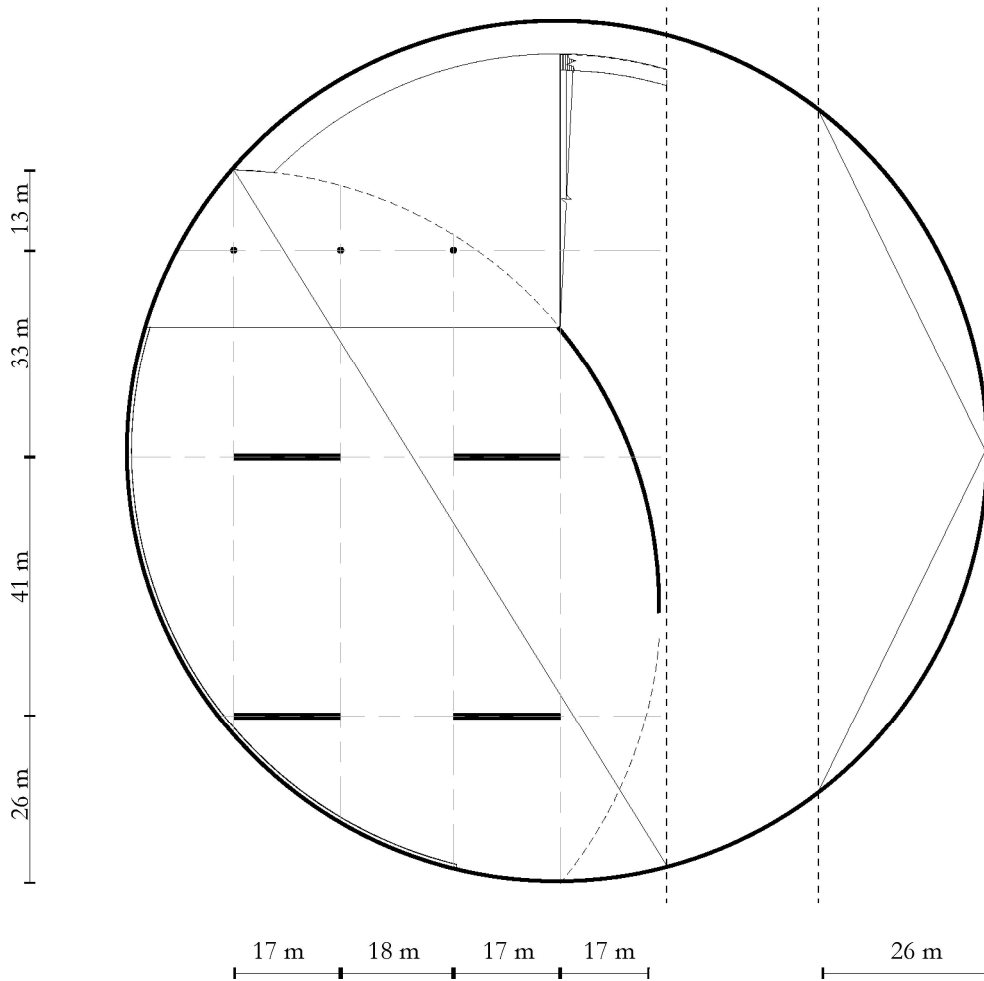
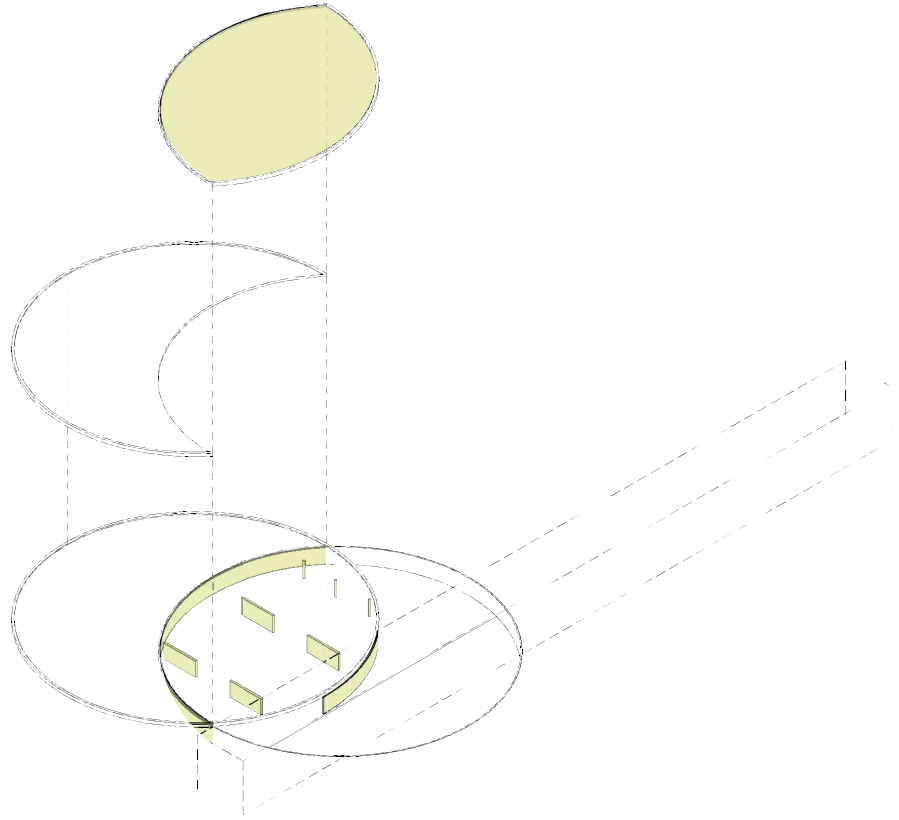



Plastiglomerate

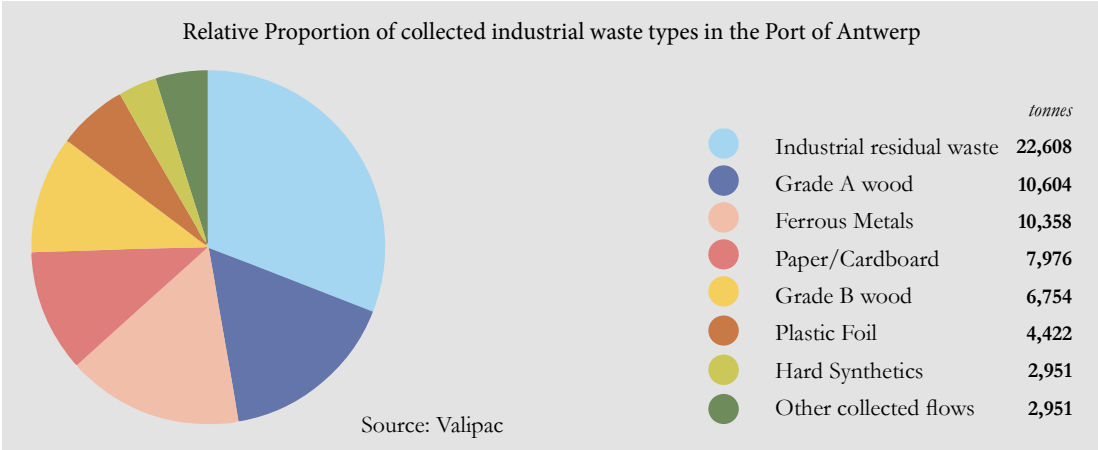
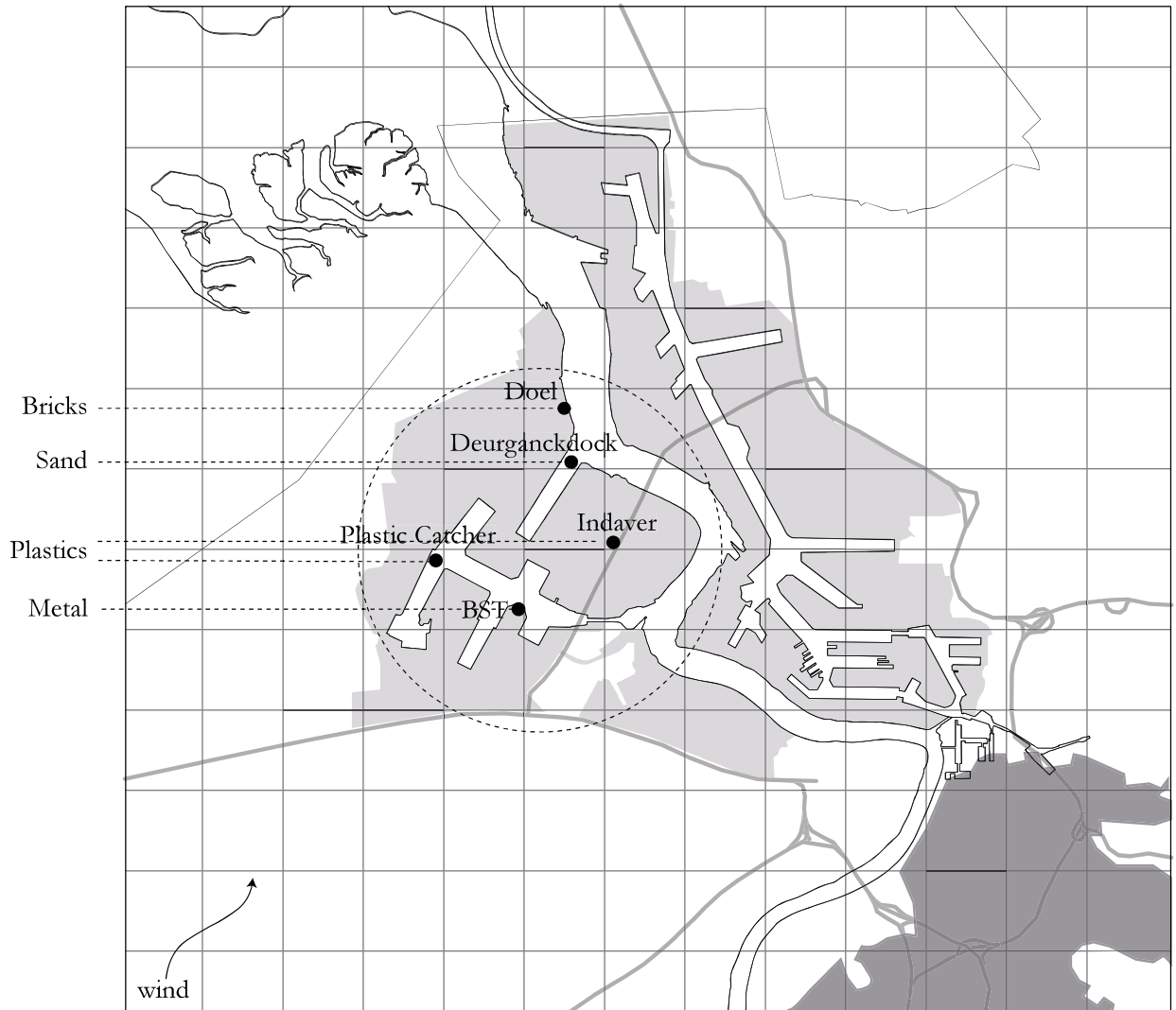

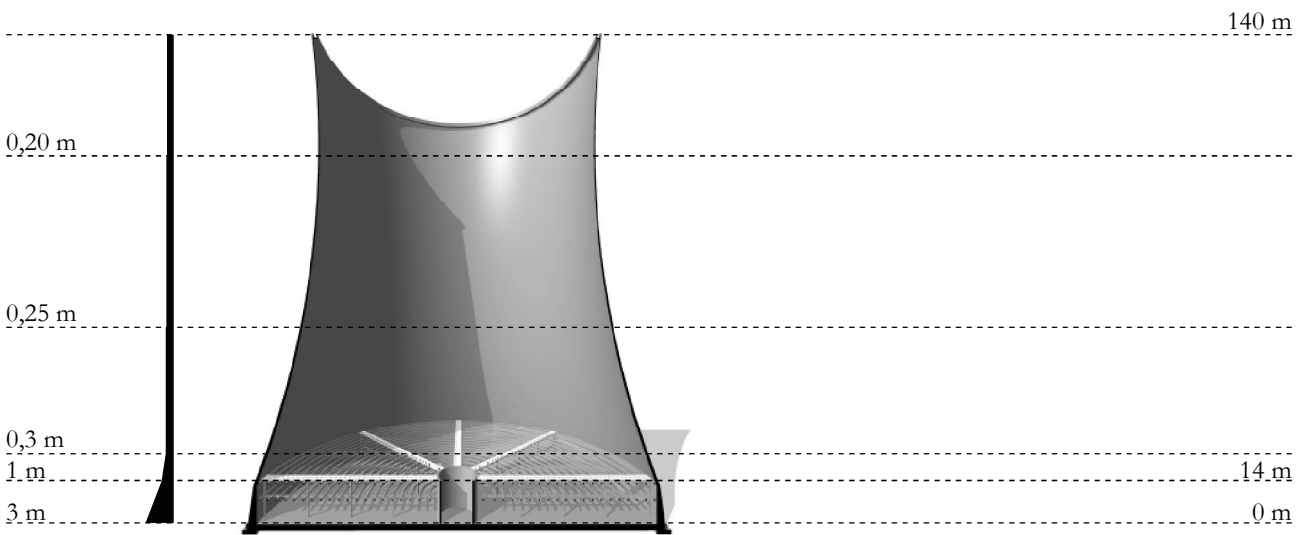
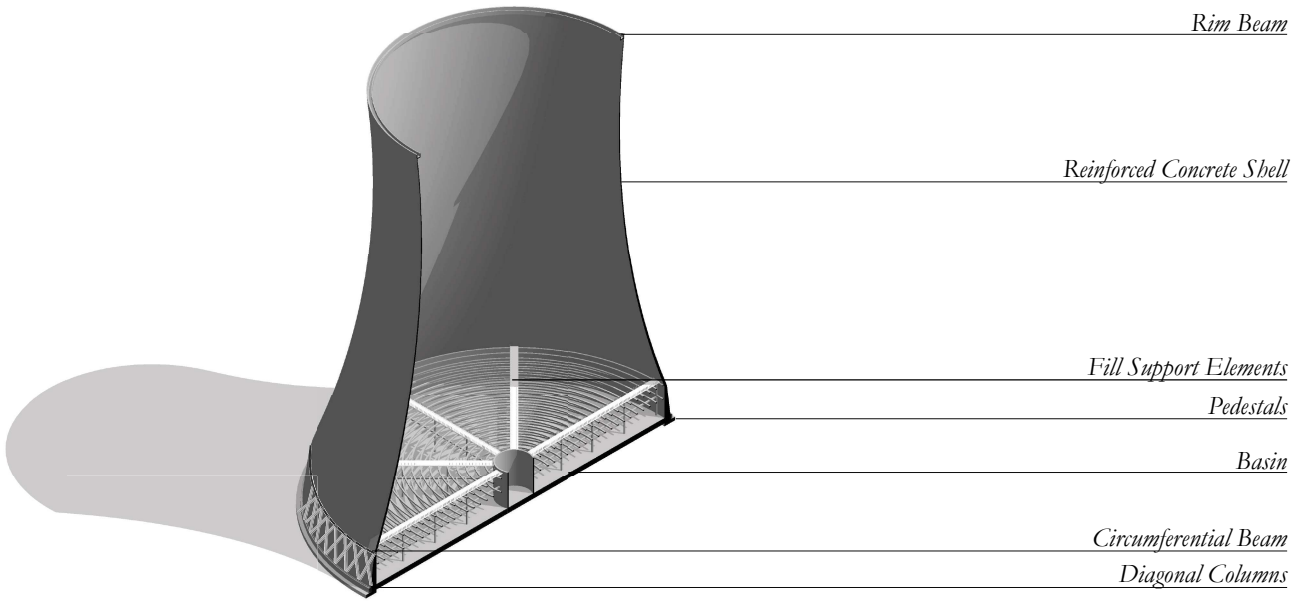

Sciaphile Plants

Conservation chambers

Circulation and work spaces

Circular balcony for visitors

Concrete shear walls

Reinforced tridimensional steel trusses

Steel mesh "fabric" facade

Mixed foundation: concrete bed on piles

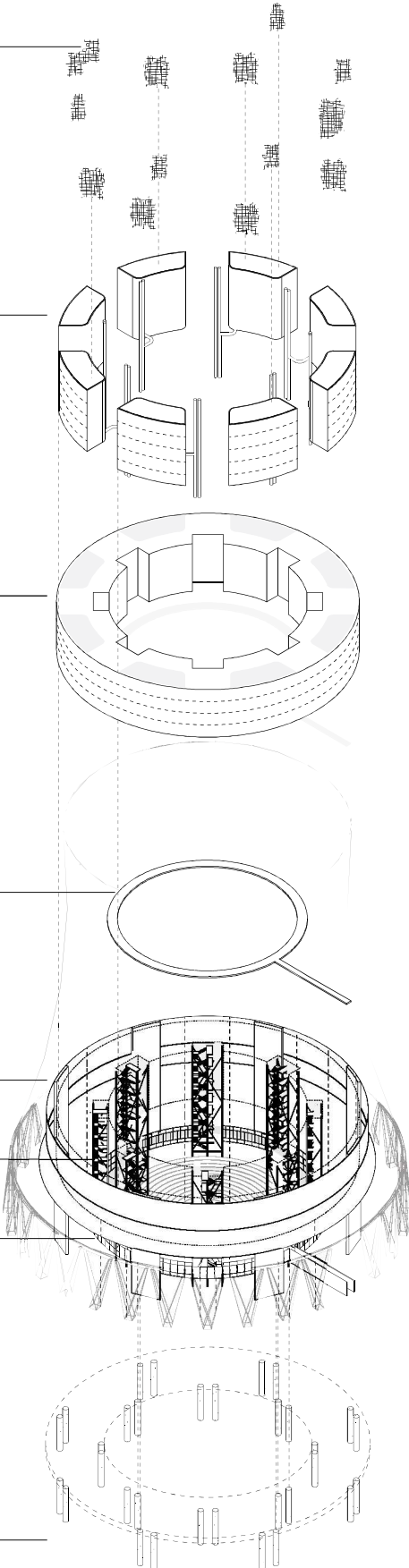

The Panoramic Tower is physically linked to the water-level-rise process. When/if the level of the Scheldt rises above 2 meters, the whole area will be flooded in case of storm surge and any human survival unlikely. In these circumstances, the water will trigger the fall of the tower and a self-destruction of the facility, thus spreading the seeds contained in the vault all over the area and favouring the rebirth of nature in unpredictable climatic conditions.

To allow the construction of the 170 m high tower, a concrete box foundation with piles would be necessary, this base would be 12 x 12 m and 3 m deep into the ground. The tower is then double-hinged (in perpendicular directions) to the foundation. The vertical load bearing elements work together as a tridimensional braced vertical truss structure reinforced at the core.

The mechanism of destruction of the tower is placed underground and attached to the foundation: a winch connection lays at the bottom of a tank and it is then linked to the hinge connection at the base of the tower. The tank is then closed apart from an opening topped with a metal grid.

When/if the water level will raise to the “*point of rupture*”, the water will start flowing in and adding weight by filling the tank; the increased weight will then make the tank drop causing the winch mechanism to pull the hinge until its breaking point. At that point, the wind will be able to easily blow the tower down, by pushing it to rotate around the other hinge foundation and eventually falling over the other structures. A concrete tank filled with sediments and debris placed on top of the structure will ensure the fall of the tower and will add necessary weight to the destructive action.

Concrete box filled with debris and coated with marble plates



Steel staircase



Steel mesh facade

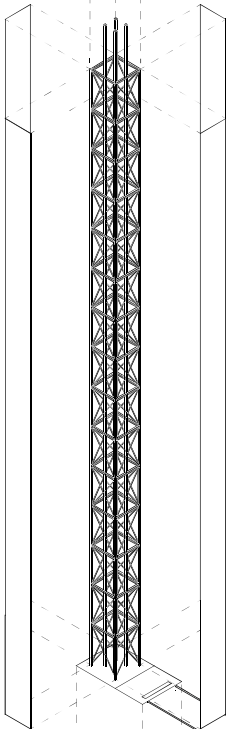

Concrete box foundation with embedded tank

Wall for sea-level rise warning

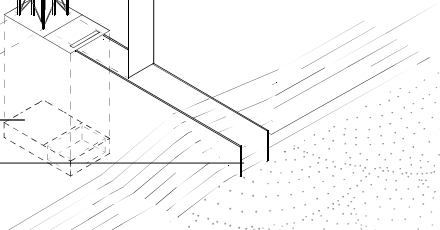

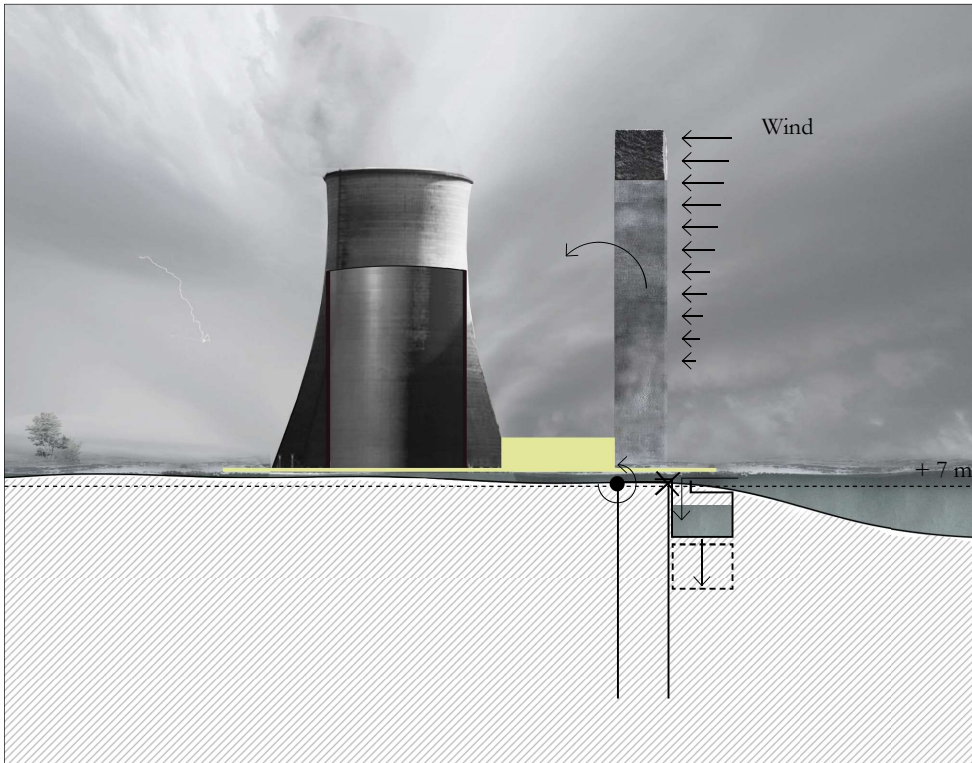

1.

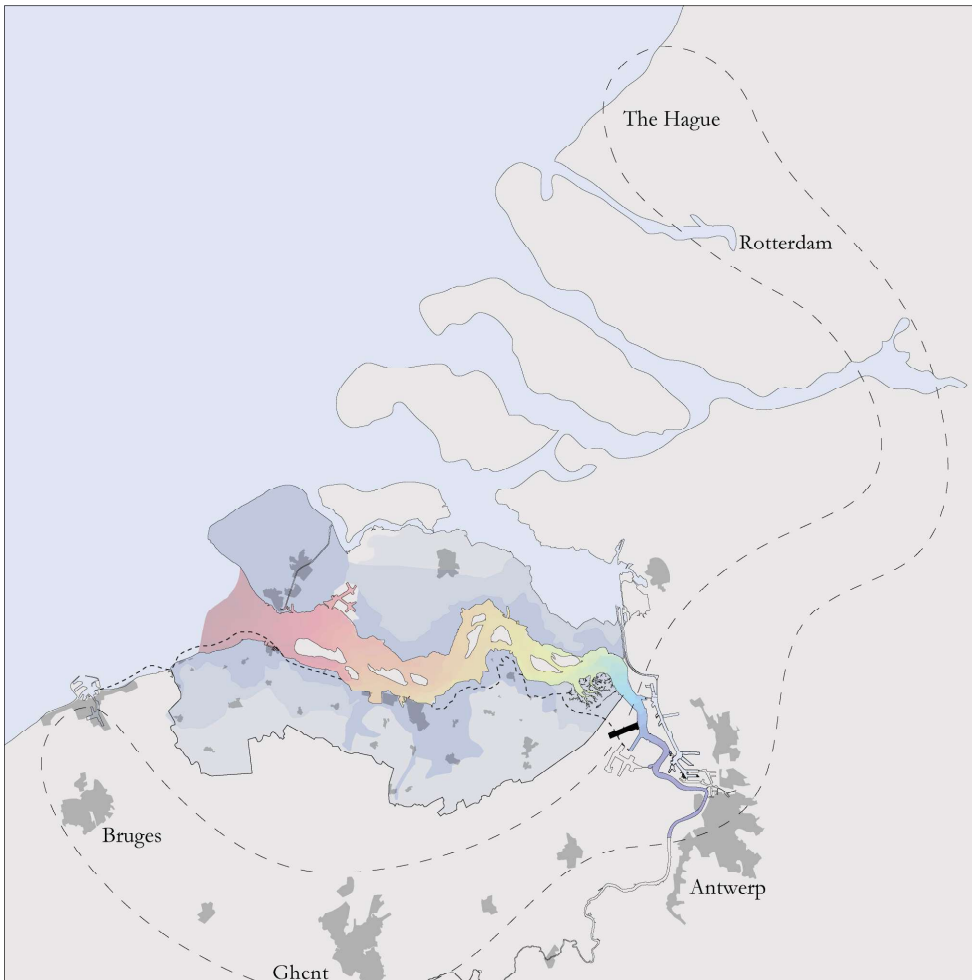

2.



3.



4.



5.



6.

Timeframes

1. Destruction Structural Scheme
2. Scheldt Hazard Map
3. 2025 Scenario
4. 2050 Scenario
5. 2100 Scenario
6. 2150 Scenario

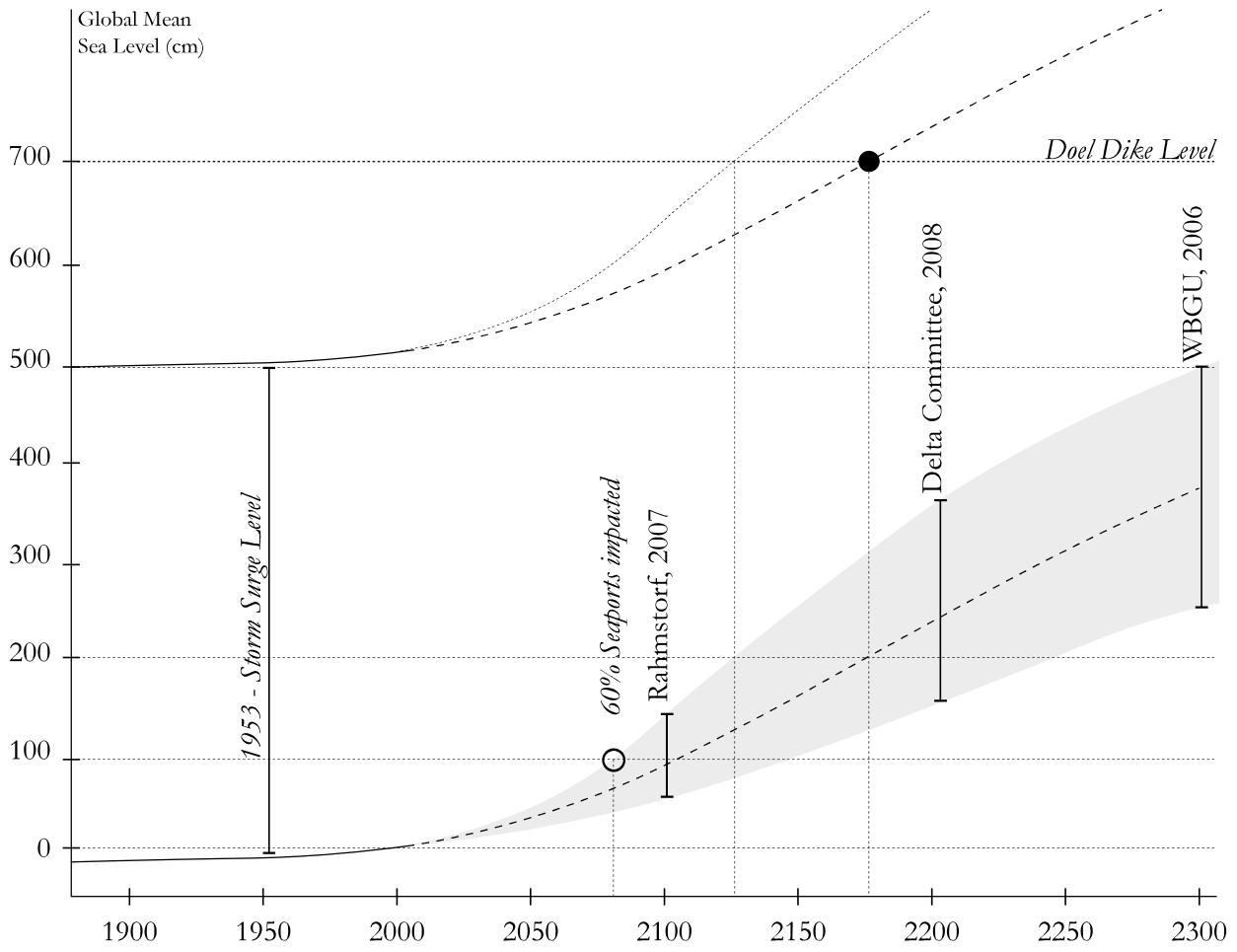

Sea Level Rise Prediction Diagram

Hinge
Winch
Tank

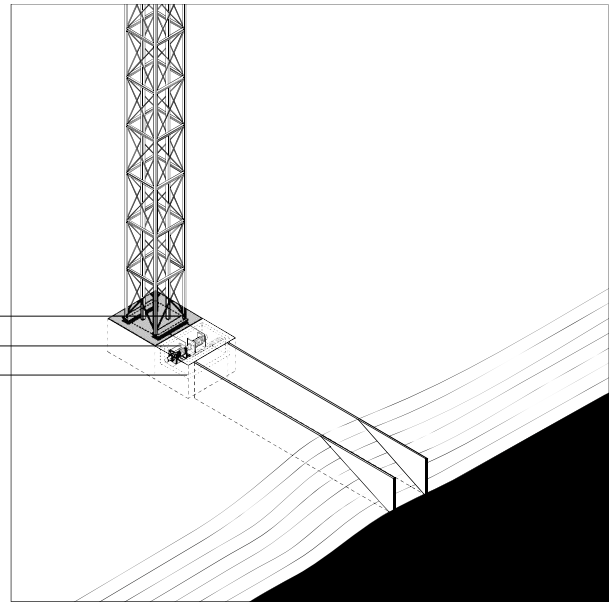

1.

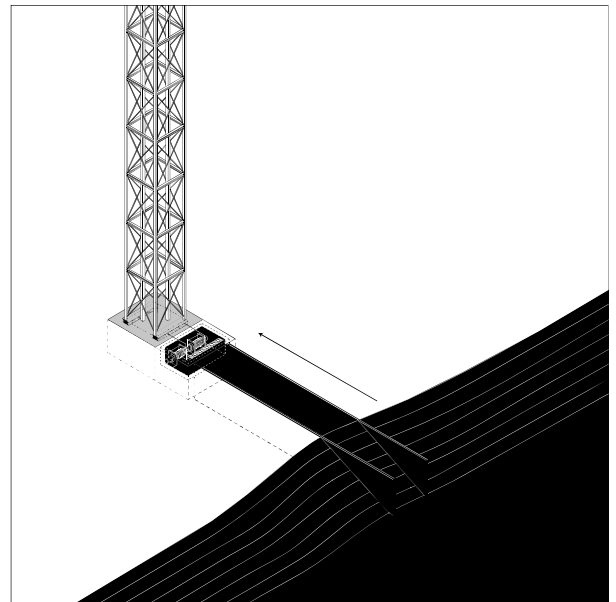

2.

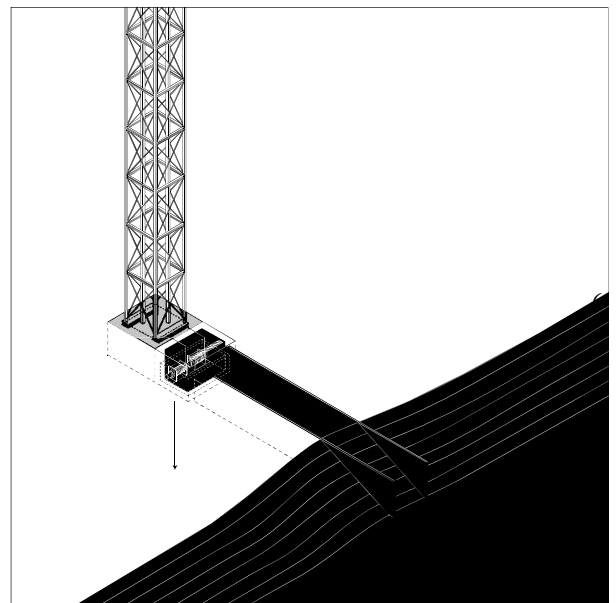

3.

Timeframes

- 1. Static State
- 2. Filling Process
- 3. Point of Rupture

c. Climate

The climate in Antwerp is influenced by the Atlantic Ocean, therefore rather humid and rainy. Winters are cold but not freezing and summers are quite cool. The wind blows frequently, mainly from south-west, and it can be intense especially from November to March. Precipitation is abundant (about 850 millimeters per year) but distributed throughout the year. The rainiest seasons are summer and autumn.

Winter

From December to February temperatures are around freezing point (0 °C) at night and a few degrees above during the day; wind and humidity often strengthen the feeling of cold. When the westerlies blow, temperatures can be quite mild, and can even reach 10/12 °C. As the temperature very rarely drops below -10 °C, the Scheldt does not freeze anymore like it used to during the “Little Ice Age” (1450-1850). Snowfalls in Antwerp are quite frequent but never abundant.

Summer

From June to August the climate is mild as the sub-oceanic influence does not cease: the wind blows constantly from the sea, and rainfall is quite frequent. At night, it can be a bit cold (around 10 °C) even in July and August. The hot temperature has touched its peak in the recent years, with a highest record of 35 °C reached in 2012 and 2015.

Climate Concept

The architectural ensemble is perfectly parallel to the North-South axis, reducing to the minimum the square meters of vertical surfaces which are worst oriented. In this way the building also fully embraces the daily changes in sunlight intake as the research facility is not operating overnight.

During Summer the thermal excursion between the average outside temperature and the temperature requirements of the interior is around 4°C. In the morning the sun rays are filtered by the vegetation line on the east side of the building, preventing the curtain walls and the glass-covered atrium to overheat. In the afternoon, the overhang upper volume and the loggia also work as shading stratagems for the west facade of the building, especially for the public spaces, as the laboratories are shaded by the cooling tower volume. Furthermore, the wind coming from south-west is “channeled” into the loggia to cool down the vertical surface on the west side. Operable openings will then allow cross ventilation only on the southern part of the complex of buildings (public part), while the water roof and the river will contribute to avoid the heat island effect.

During Winter the naked trees will let the sun rays inside the atrium, while the extensive curtain wall will guarantee the maximum amount of radiation intake. The air current passing through the loggia will warm up the curtain wall surface assisted (in the afternoon) by the light reflected from the water roof.

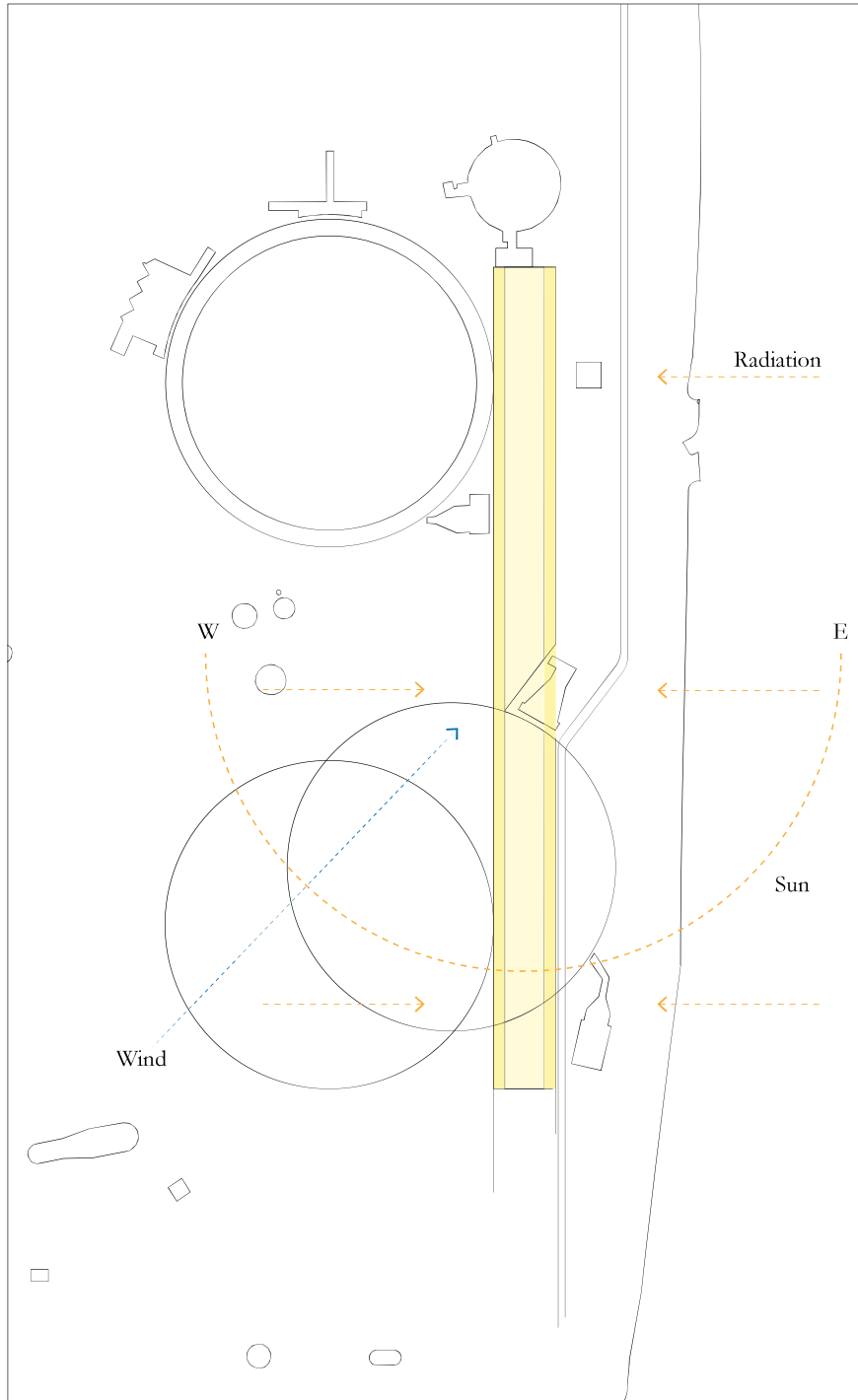

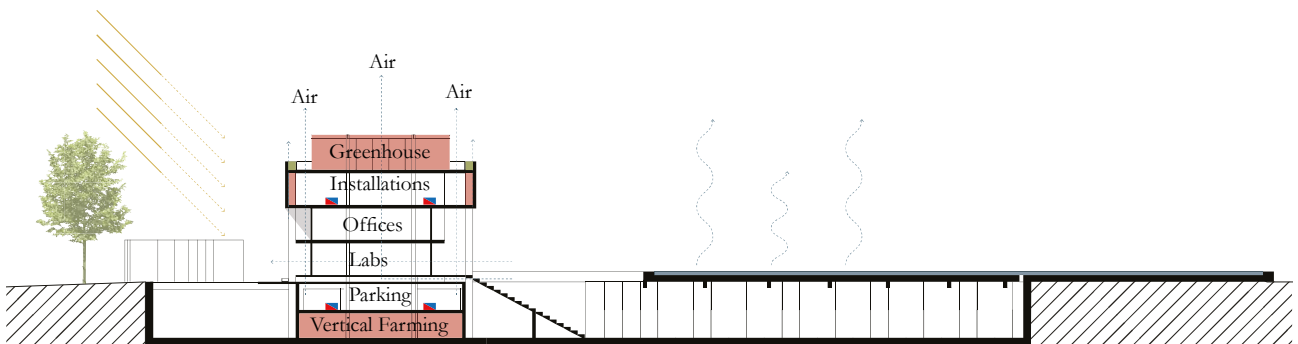
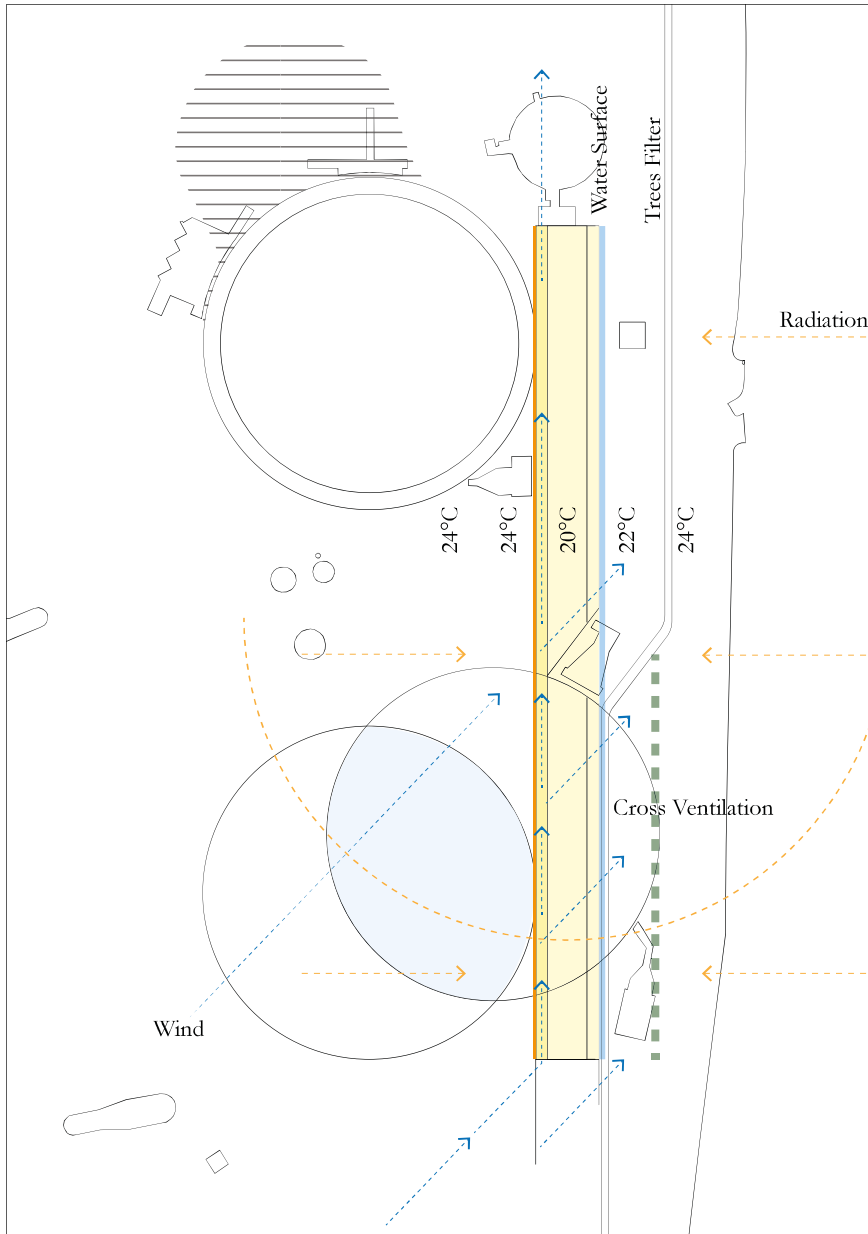

Summer Climate Concept

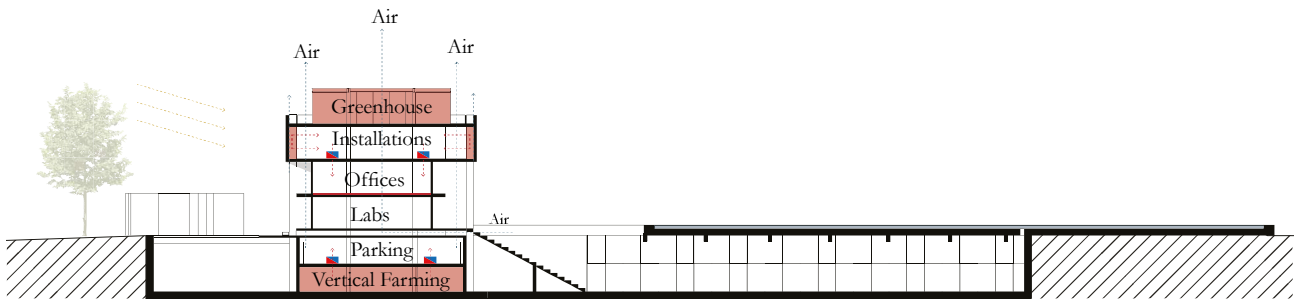
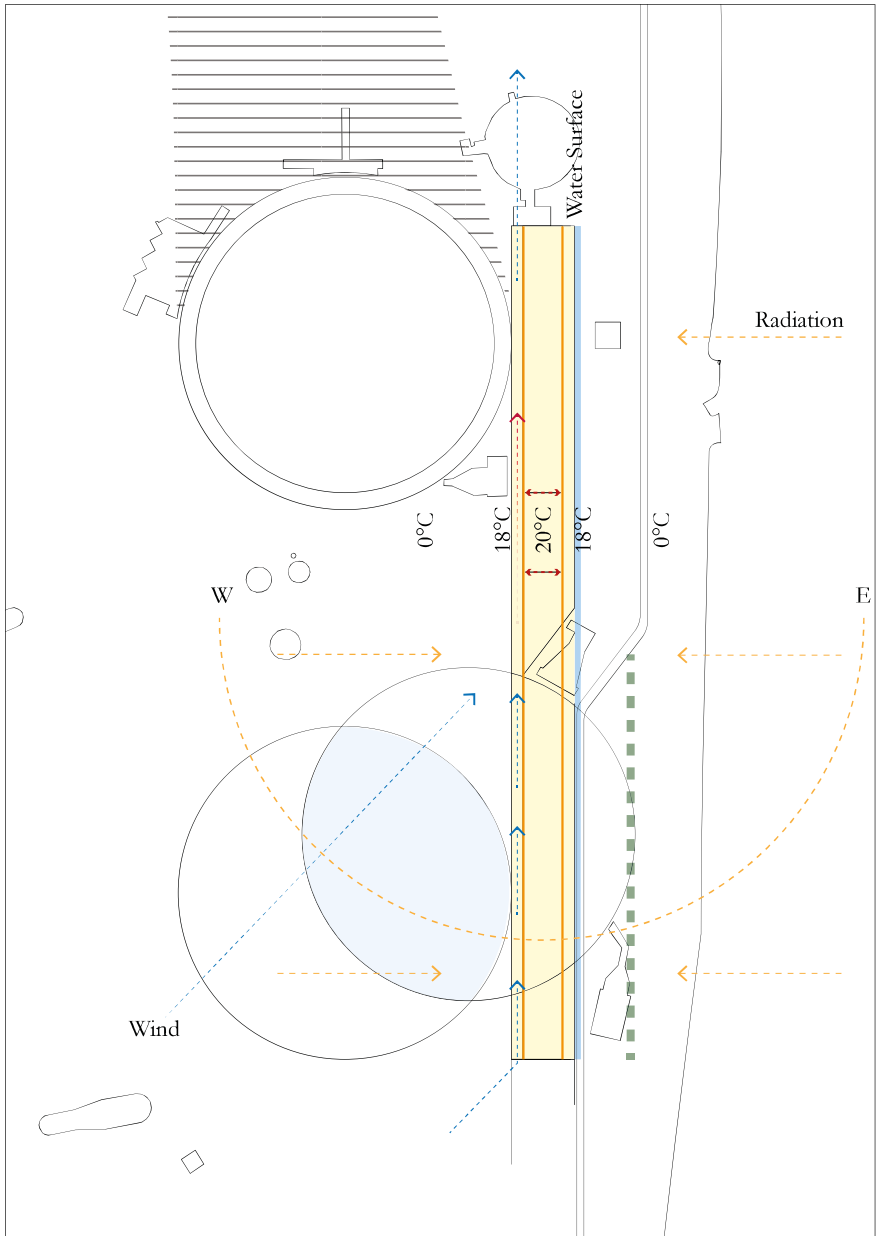

Winter Climate Concept

The climate conditions of the surroundings were taken into consideration for what concerns the water and heat cycles. Rainwater can be collected through the water roof of the building, through the reservoir inside the cooling tower or through the former (recovered) nuclear pools, and then redirected to the public aquifer using the existing water pumps on site. A phytoremediation filter can depurate the water from the tidal basin and also send it to the aquifer. Lastly, water for specific labs operation will be treated in the facility both before and after use: waste fluids can also be redirected to the phytoremediation filter and then re-enter the public network.

Residual heat from the Port industrial areas can supply not only the building, but also the farms scattered all over the whole Doelpolder area. Viceversa, the spare heat generated by the facility can be reused, stored, exchanged with the river and then redirected to the surrounding households.

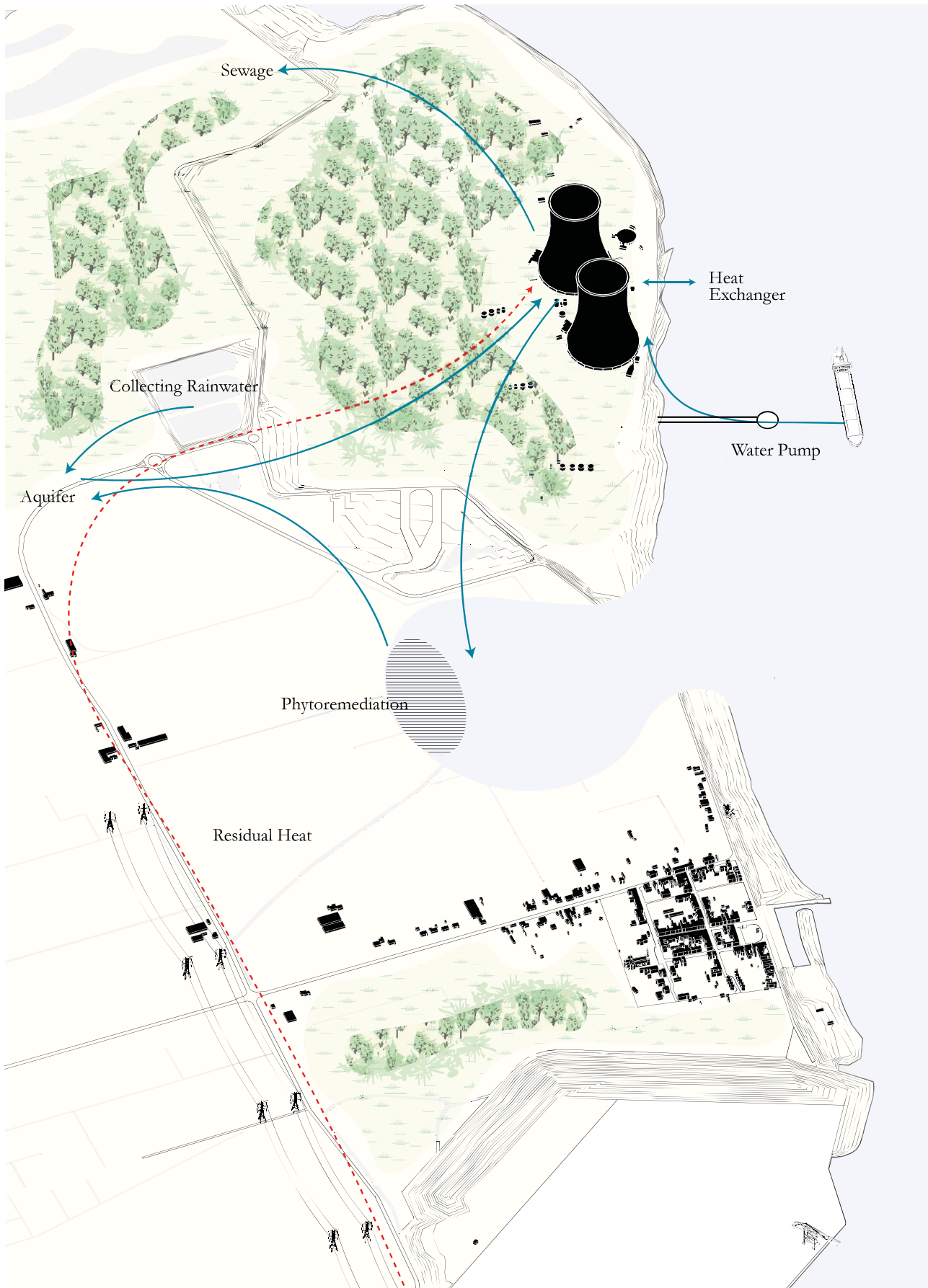

d. Facade

The facade concept is based on many different factors and principles: such as programme, availability of materials on site, climate issues, efficiency and time, this last aspect is very recurrent throughout the project.

The first two storeys are enclosed by a curtain wall of low-e glass with galvanized steel frame and thermal break, which runs from the first slab aboveground up until the bottom of the overhang volume. The third storey is only left as technical space for the accommodation of machine, pipes and tanks which are linked with every other floor through the vertical shafts. This volume is thus completely clad by precast opaque foamed-concrete panels. These panels can be produced in the nearby industrial area of the Port of Antwerp which is renowned for its production and recycling facilities of concrete, steel and aluminium.

The upper floor of the lab-scape is characterized by an alternating rhythm of greenhouses. The standard greenhouse here implemented is clad with a polycarbonate curtain wall with openable frames for ventilation and internal sunshading device. The roof is made of polycarbonate panels with transparent pv film spanned by HEA beams and shaded with an operable sail. On top of the beams sit the corrugated steel sheets for the maintenance walkways. The gutter lays on top of the edge beam which is thermally and fire-proof insulated (polyurethane) and then coated with an aluminium covering.

Finally, the upper part of the facade tries to address the theme of decay and nature rebirth over time by foreseeing a coated-wood plant pot integrated to the outer skin at the roof level. This terrain-filled container will allow the plant to grow over the facade in the future until covering the whole structure.





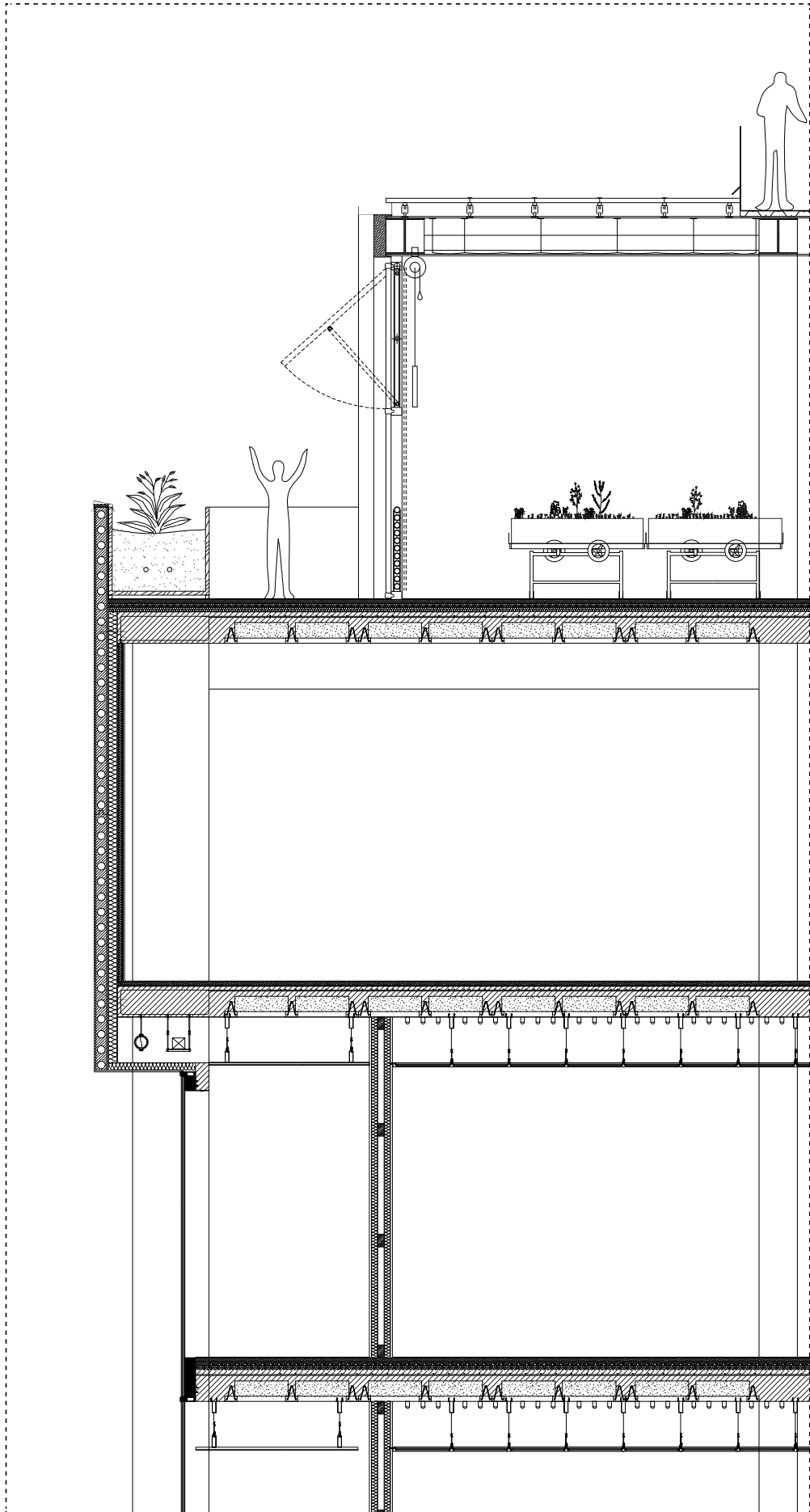

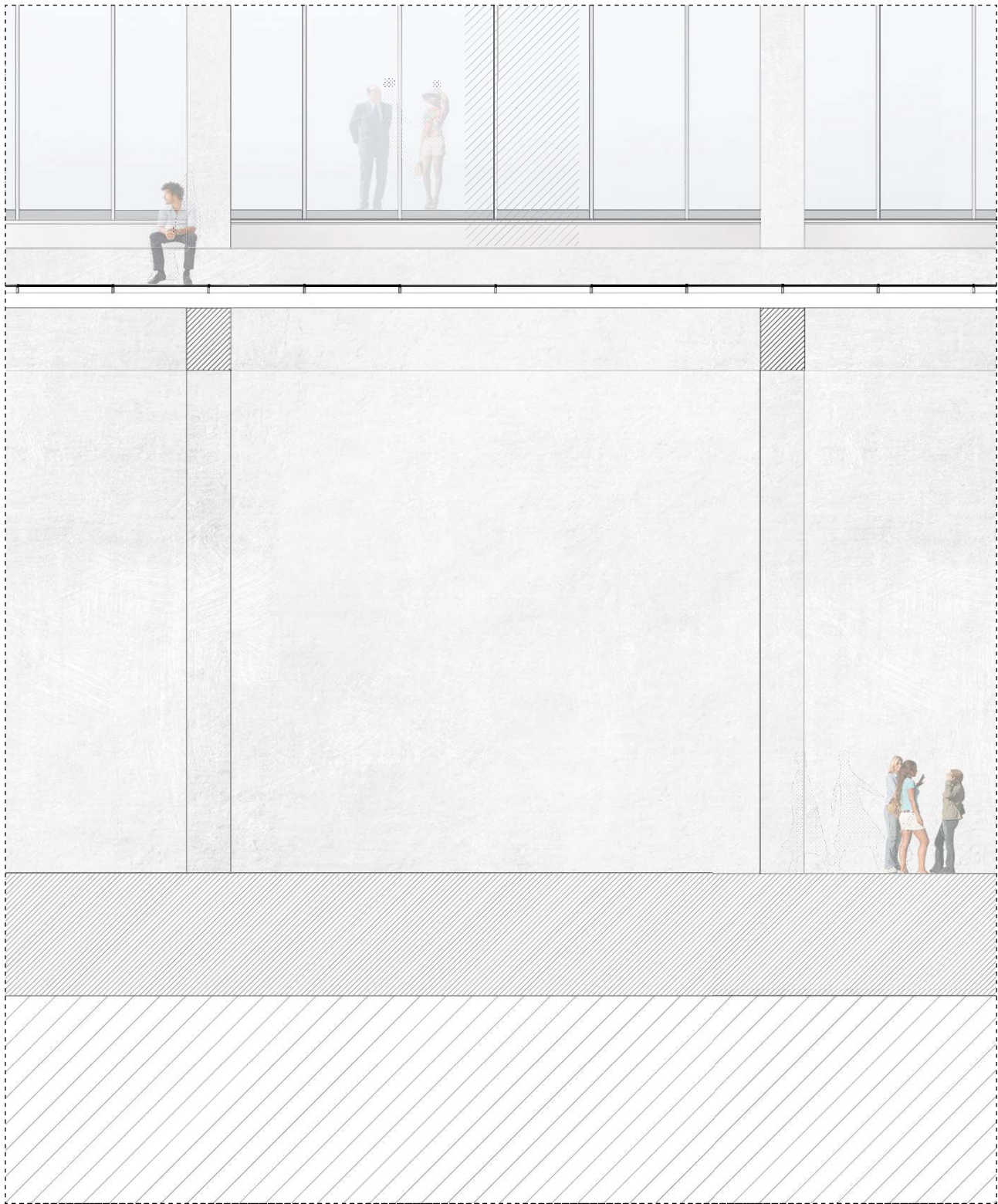

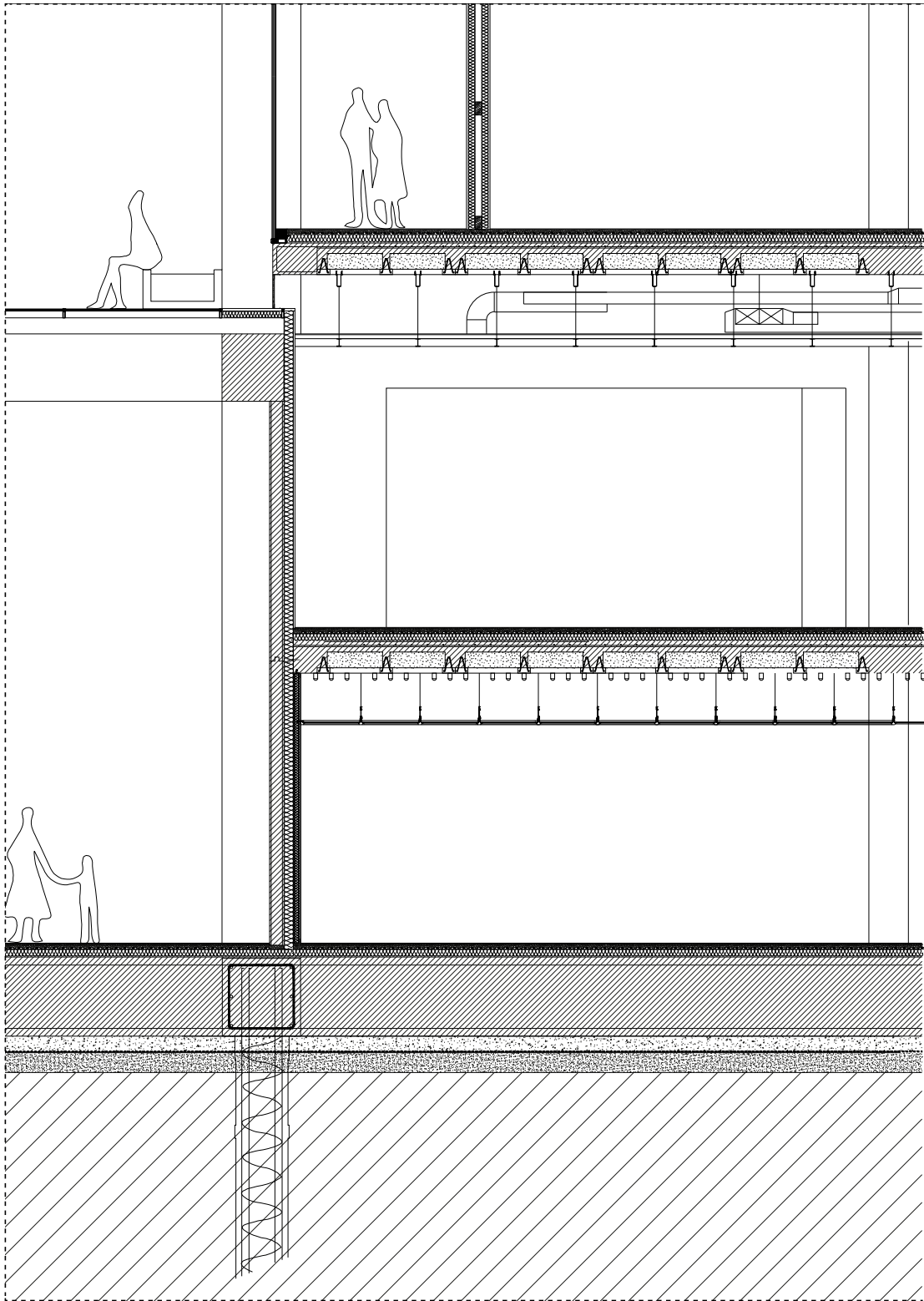

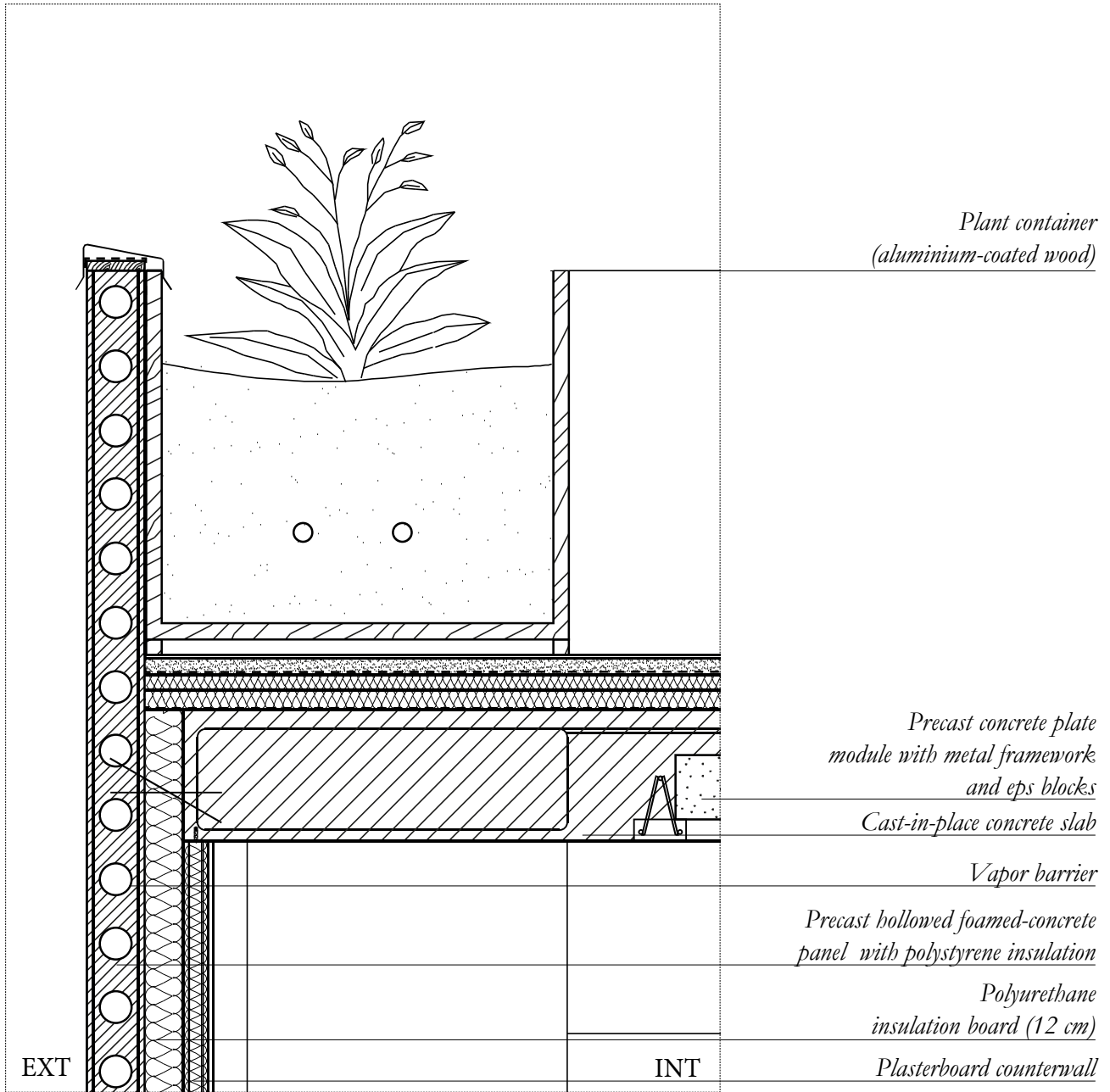

*Polycarbonate roof
with transparent pv film*

Steel Gutter

Shading Sail

*Thermal and fire proof insulation
(polyurethane) with aluminium covering*

Sunshading

*Polycarbonate curtain wall with
openable frames for ventilation*

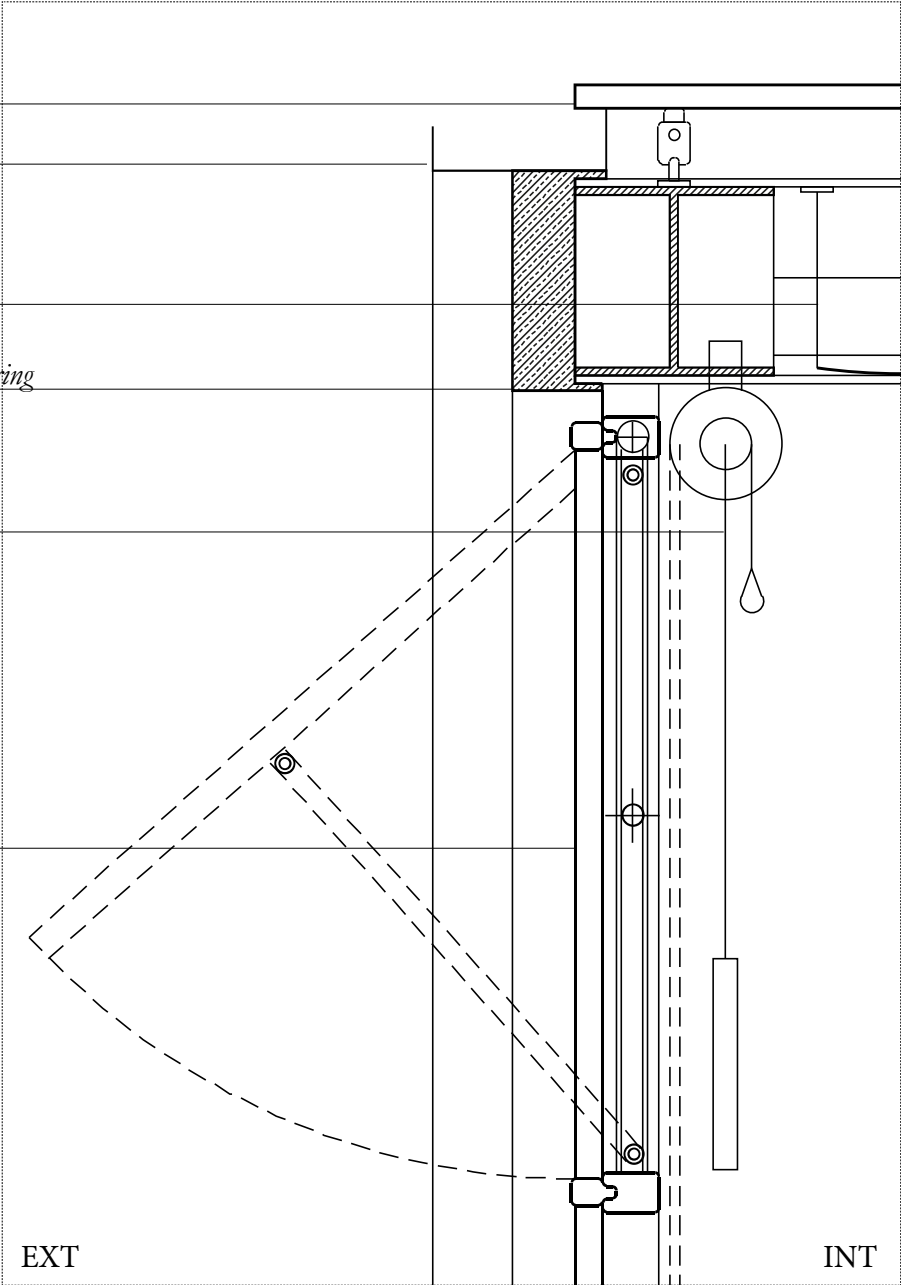

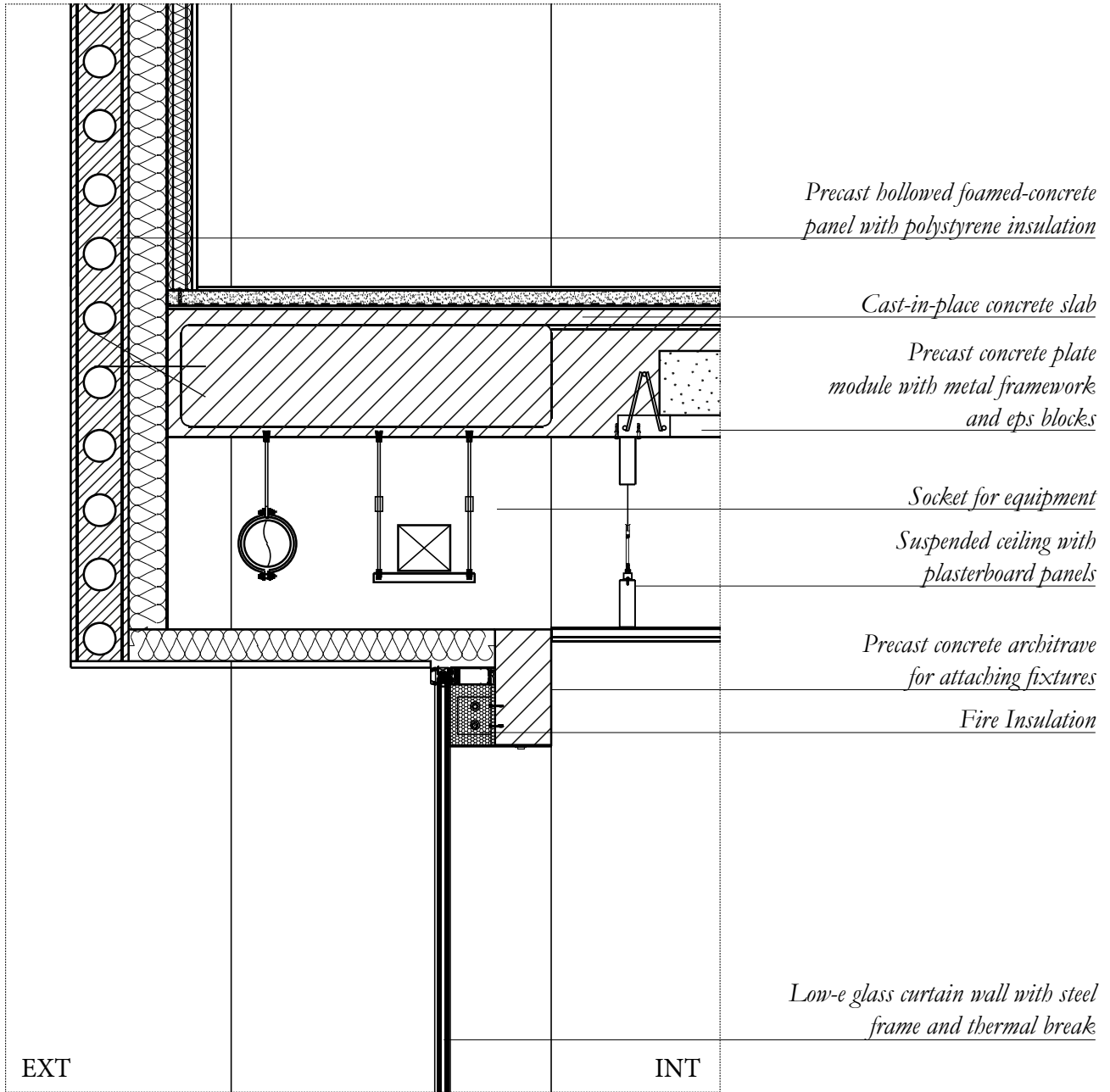

Low-e glass curtain wall with steel frame and thermal break

*Radiant Panels Heating System
Polyurethan Insulation Board (12cm)*

Closing Steel Grid

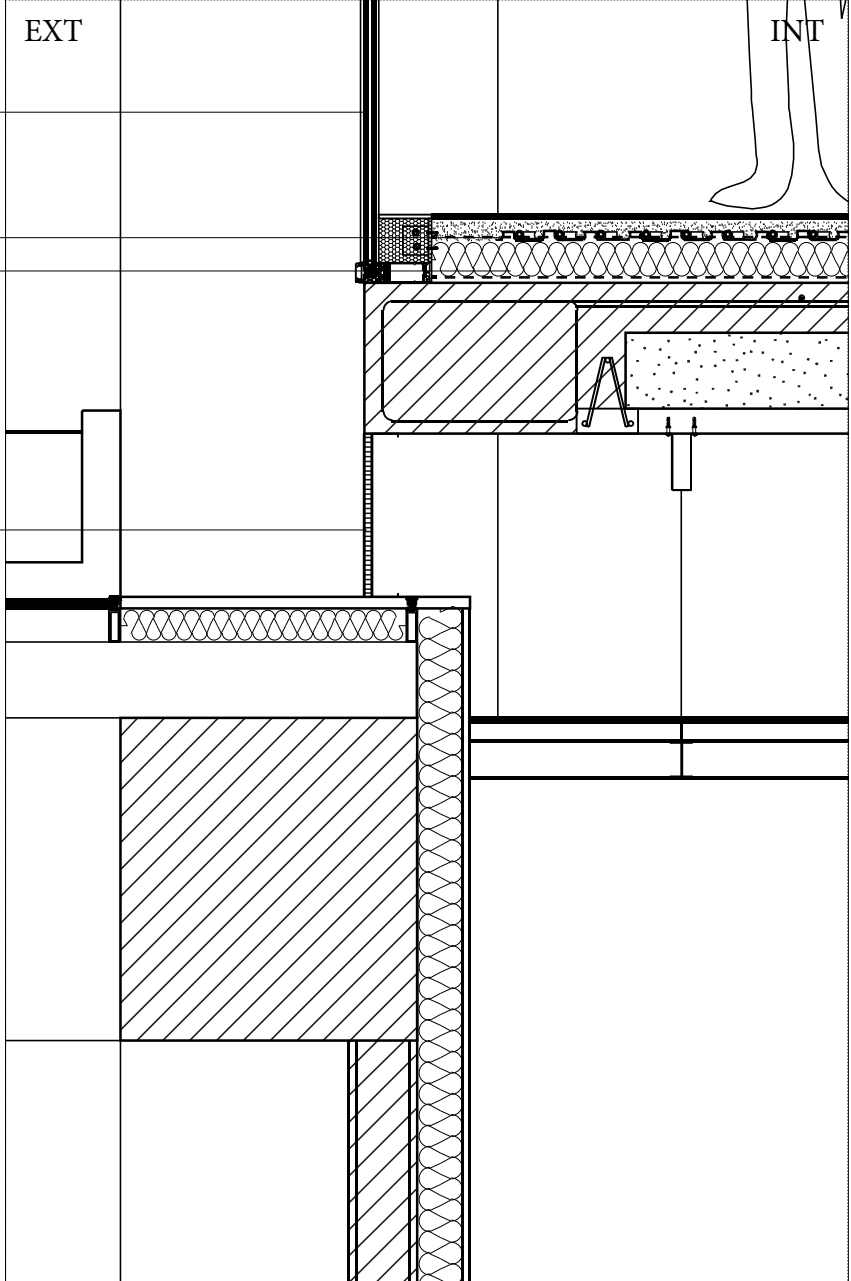

Energy Management

- Offshore: Wind farms in the North Sea (Total 58 turbines)
- Onshore (Total 70 turbines):

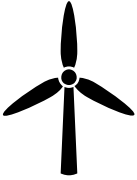

Wind energy park on the right bank of the Scheldt (19 turbines: 3 MW power)
 Wind energy park on the left bank of the Scheldt, Beveren, Liefkenshoek (15 turbines: 3 MW power)

Energy surplus: $75000 - 23800 = 51200$ MWh per year

Wind turbine average production: 6000MWh per year
 Offshore wind production capacity = 348000MWh per year
 Onshore wind production capacity = 420000MWh per year



Beveren Plant (Liefkenshoek) – produces 20000 MWh per year, running on 60'000 tonnes per year of waste (90% industrial, 10% agricultural)

- Installed in the Port of Antwerp: 200,000 solar panels across the Port area
- Concentrated Solar Thermal Plant (CST) in Beveren (Liefkenshoek)



- “Solar Pool”: Area = 14700 m^2
- Greenhouses Roofs: Area = 4300 m^2

Total Area Solar Panels: 2 hectares
 Efficiency Solar Panels = 500 KWh/m^2
 Production capacity = $500 \text{ KWh} \times 20000 \text{ m}^2 = 10000$ MWh per year



- Hydroturbine (Stream Power)
- Tidal Power Plant in Doelpolder: could produce 65000 Mwh per year

Building Consumption:

- Cooling Storage Facility:
 Total Area = $22,000 \text{ m}^2$ (Seed Vault) + 9300 m^2 (Warehouse) + 9300 m^2 (Vertical Farming) = 40600 m^2
 Average consumption: 270 KWh/m^2 per year
 Total consumption = $270 \text{ KWh} \times 40600 \text{ m}^2 = 10900$ MWh per year

- Greenhouses
 Total Area = 4300 m^2
 Average Consumption: $21,5 \text{ KWh/m}^2$ per year
 Total consumption = 90 MWh/m^2 per year

- Labs
 Total Area = 3280 m^2
 Average consumption: 3900 KWh/m^2 per year
 Total consumption = 12792 MWh per year

Total building consumption: $10900 + 90 + 12792 = 23800$ MWh per year
 Total energy production introduced with intervention: $65000 + 10000 = 75000$ MWh per year
 Energy surplus: $75000 - 23800 = 51200$ MWh per year





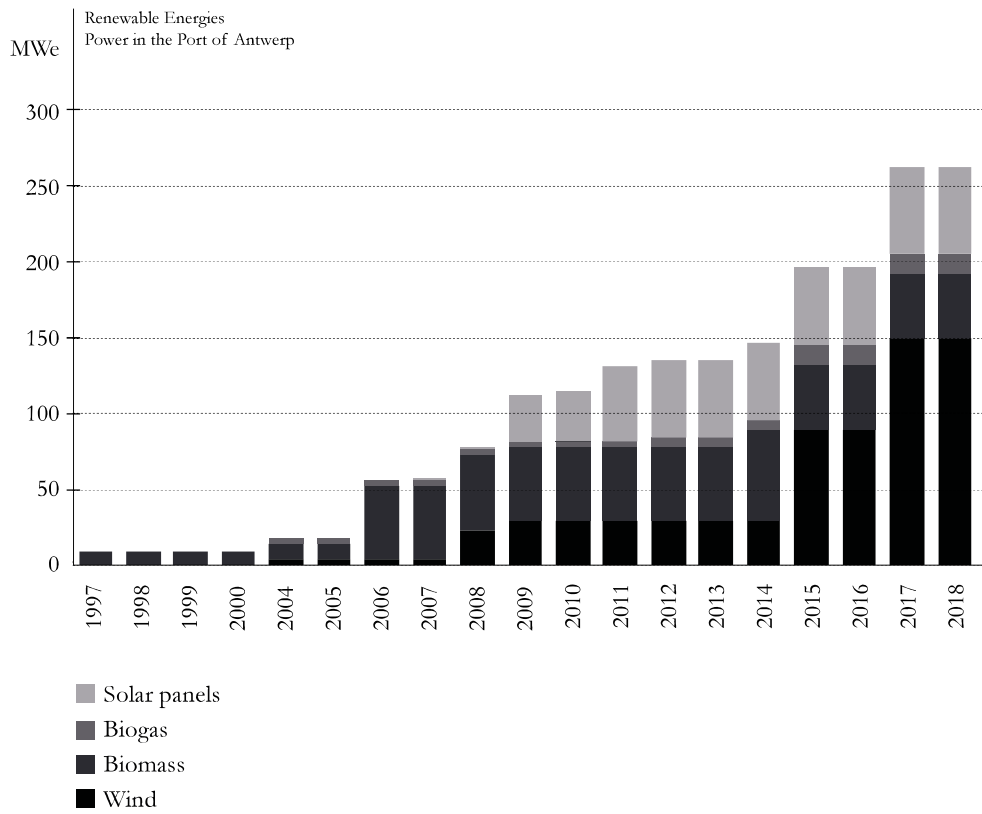
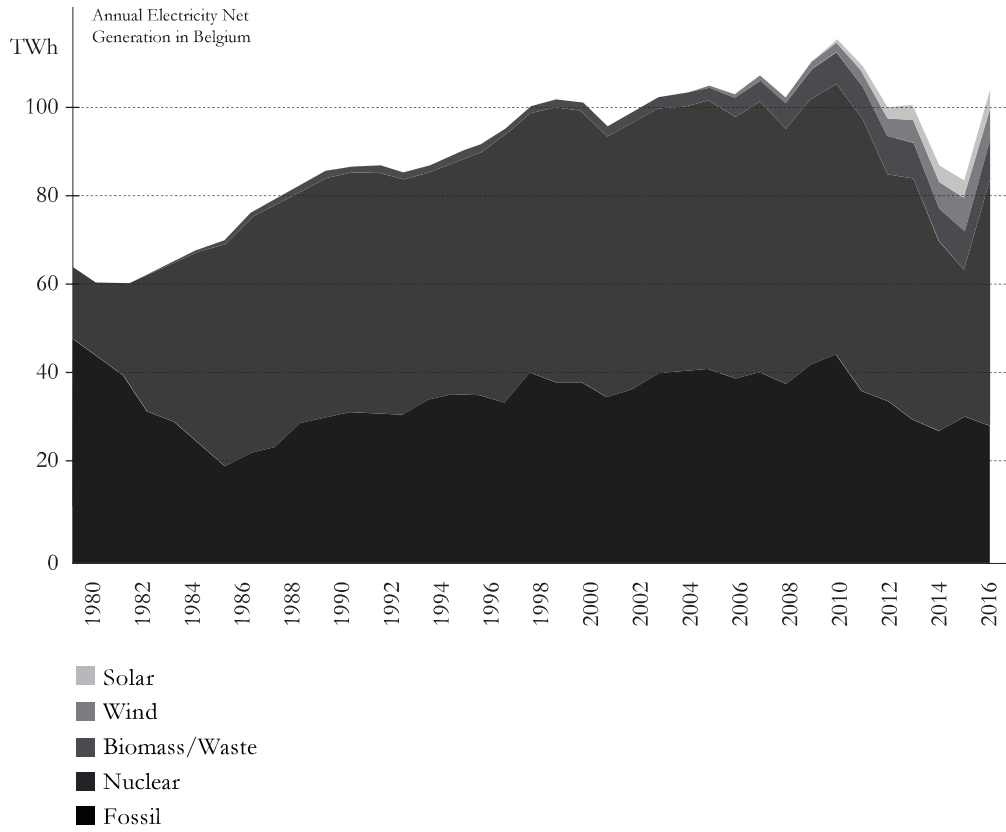

Past and Present Machinery

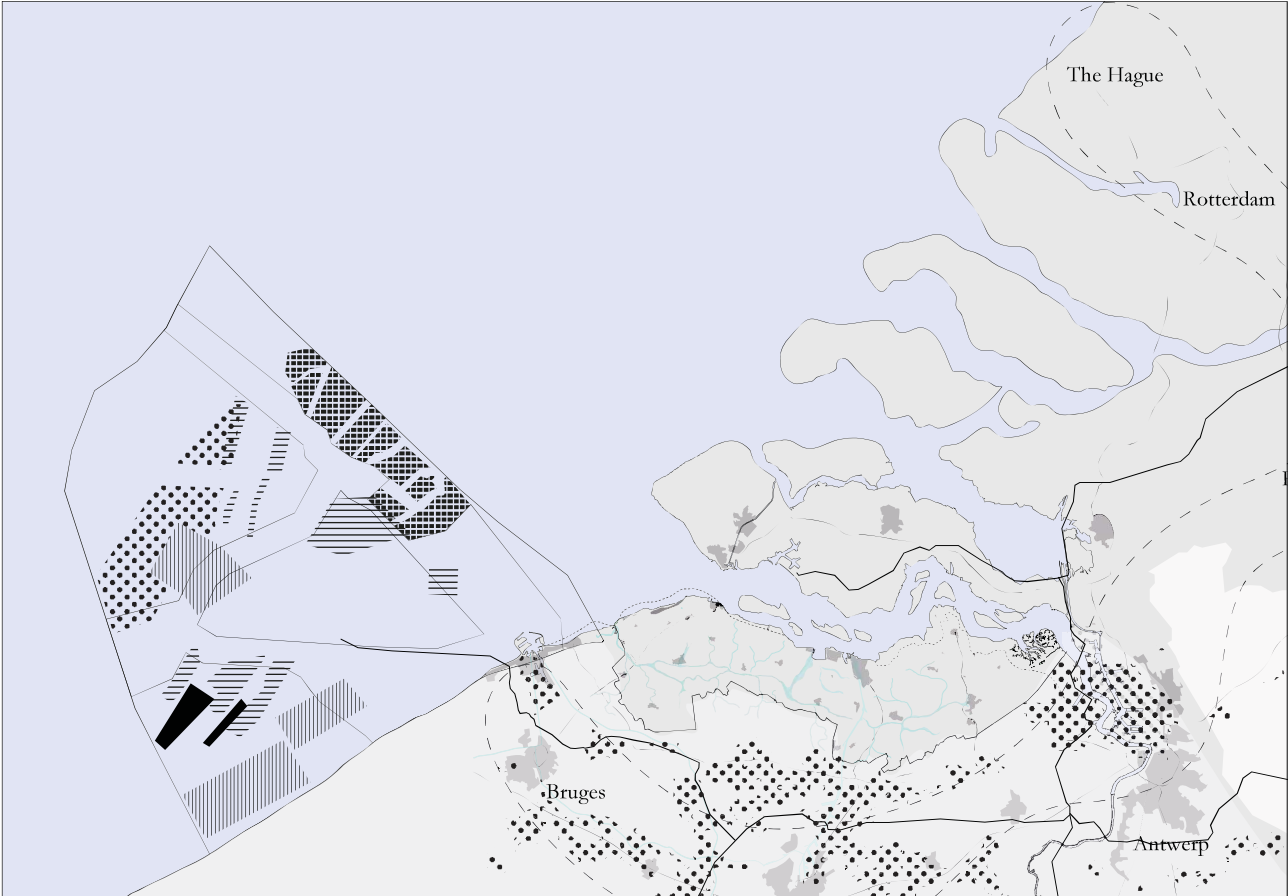

(source: VREG and Antwerp Port Authority)



Belgium Renewable Energies Plan

-  Windfarms
-  Exploitation Areas
-  Fishing Zones
-  Potential Renewable Energies
-  Wave and Tidal Energy

Building Technology Report

III.

Appendix

Building Technology Report

a.

Floor plans

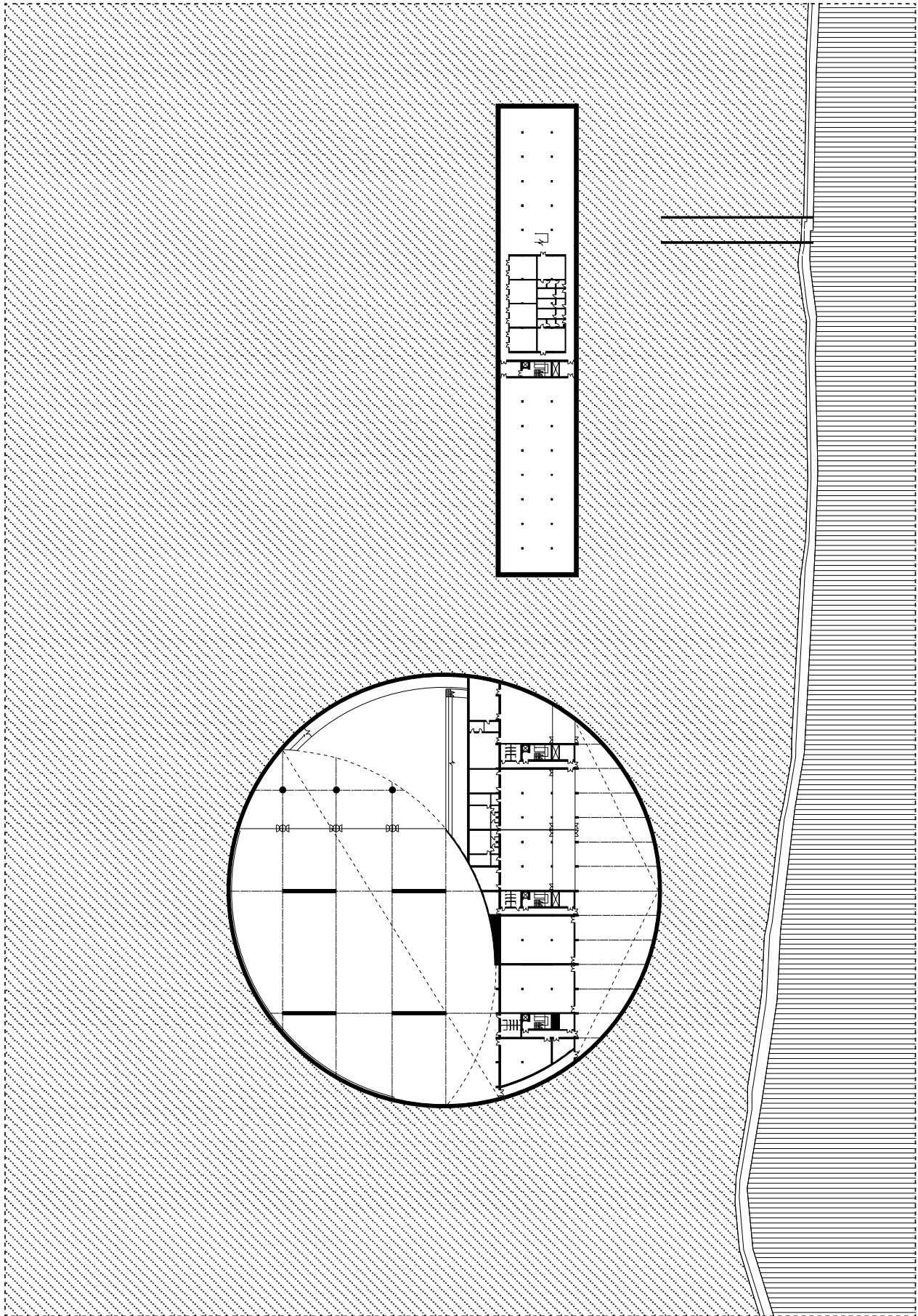

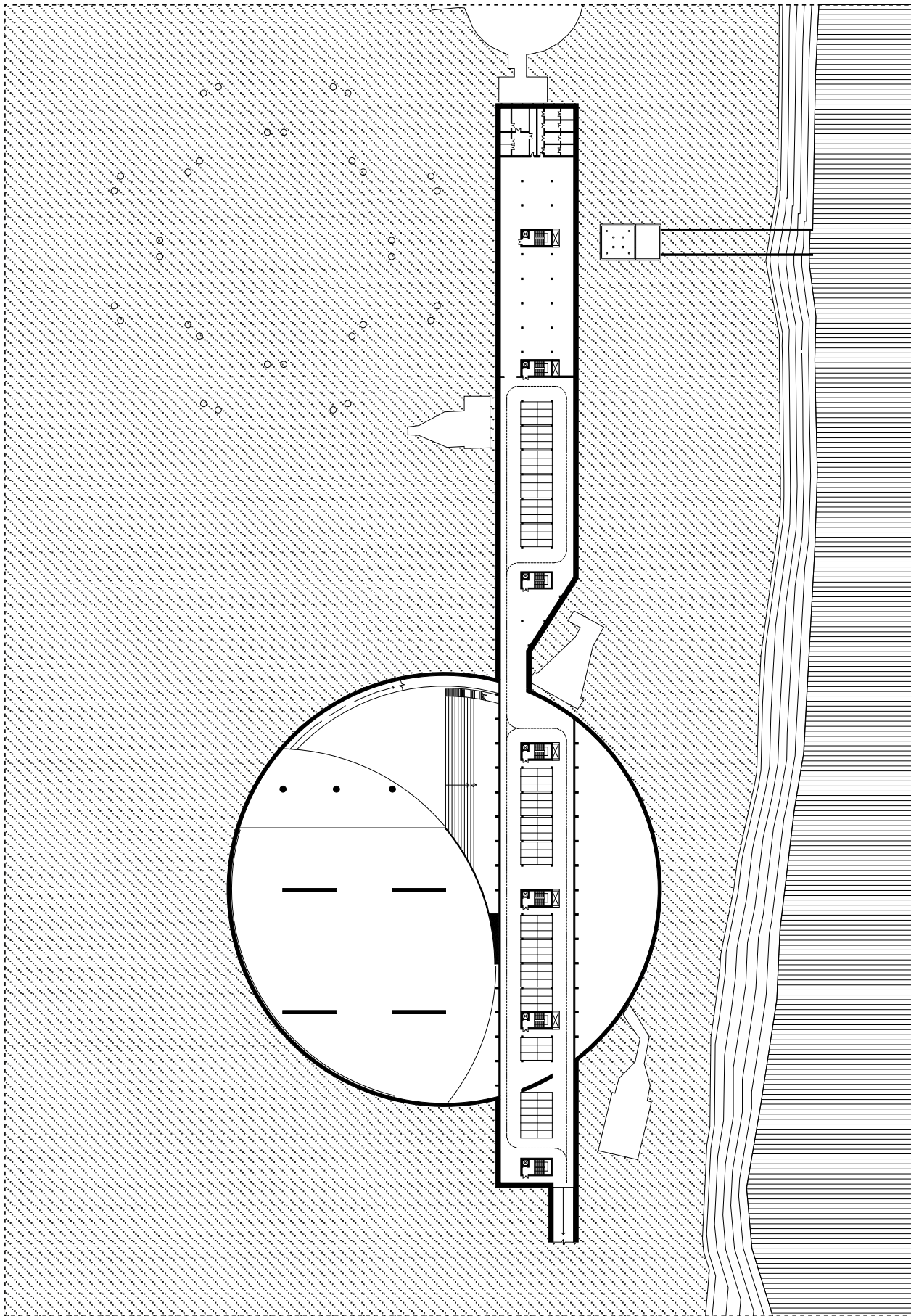

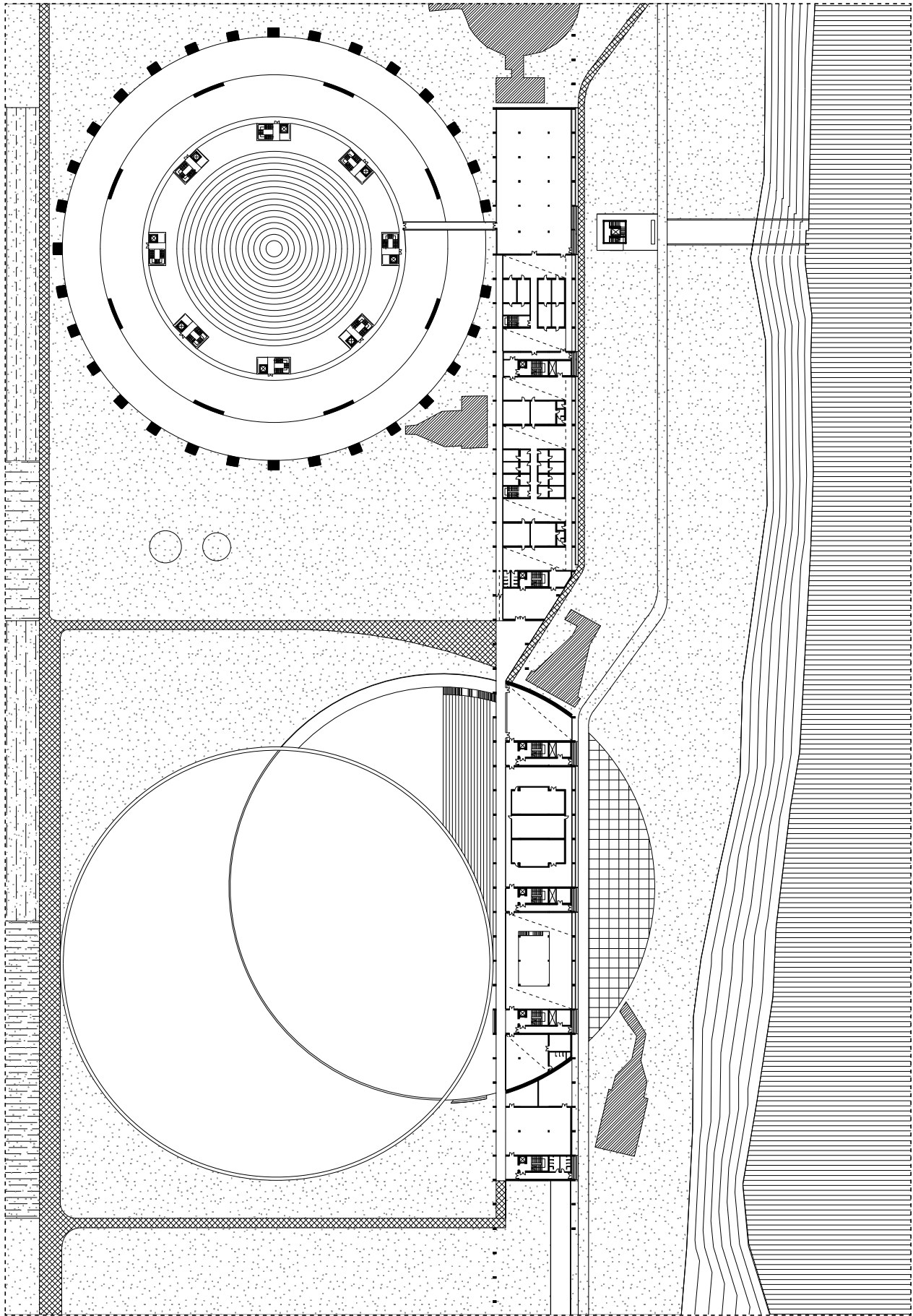

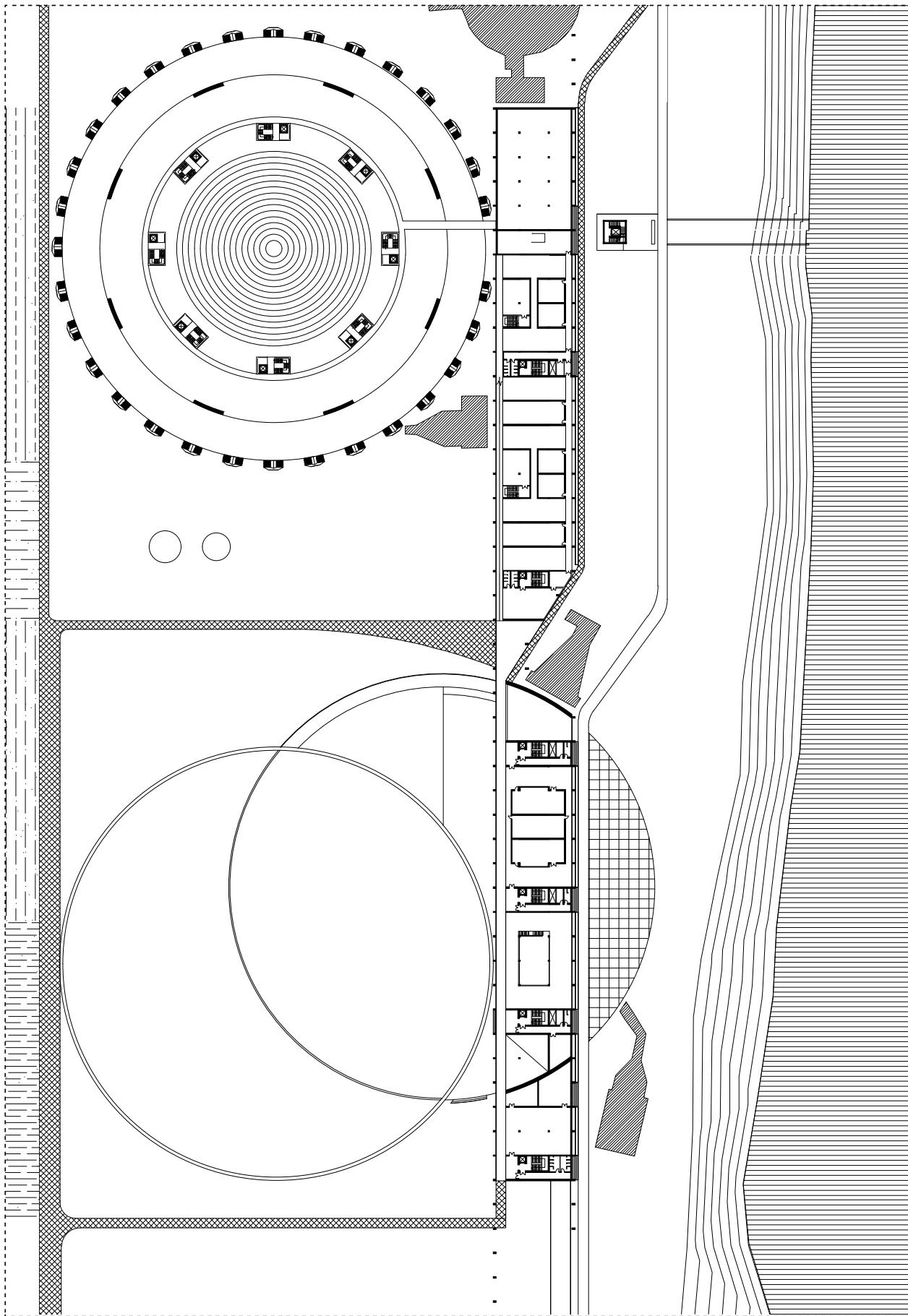

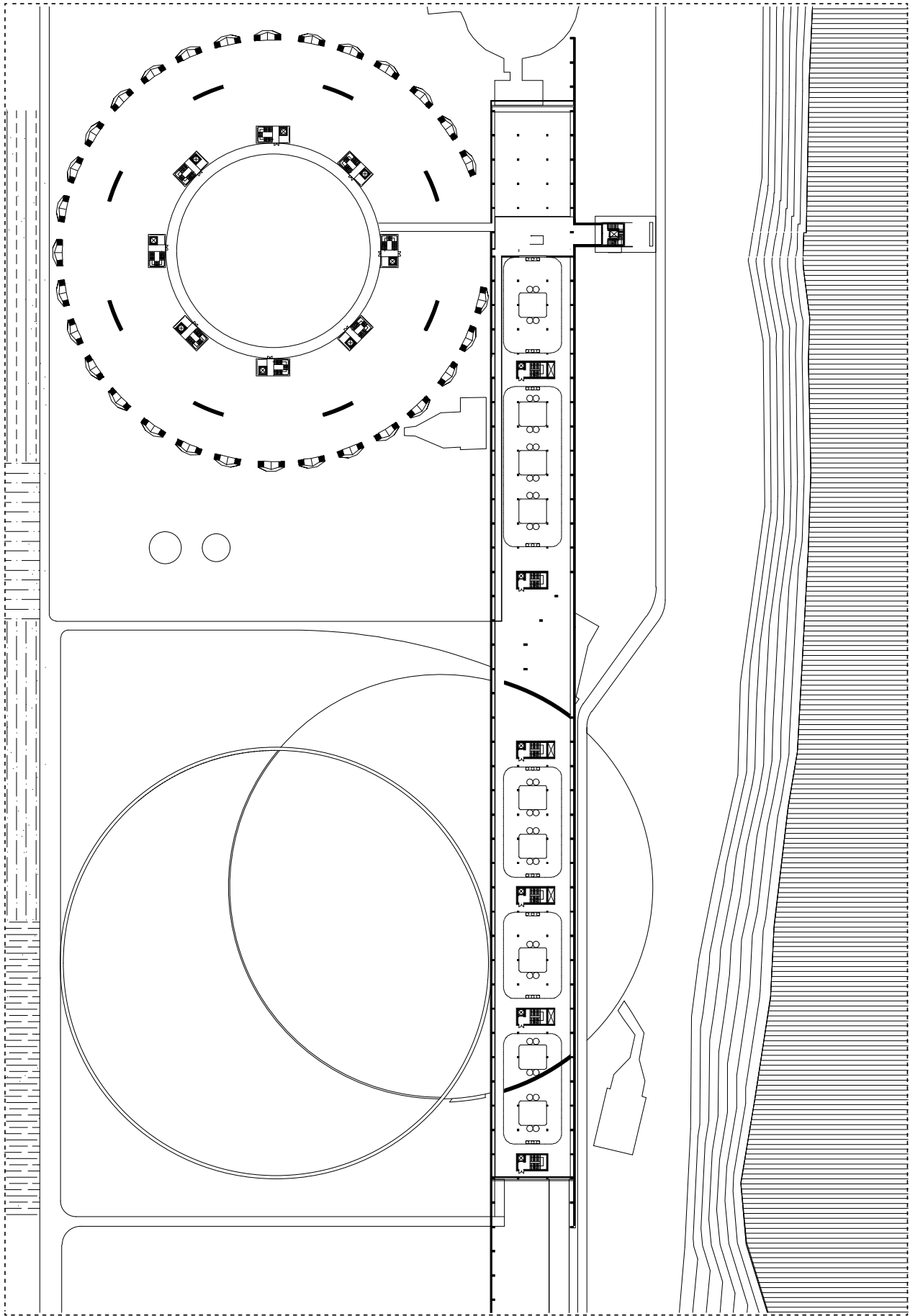

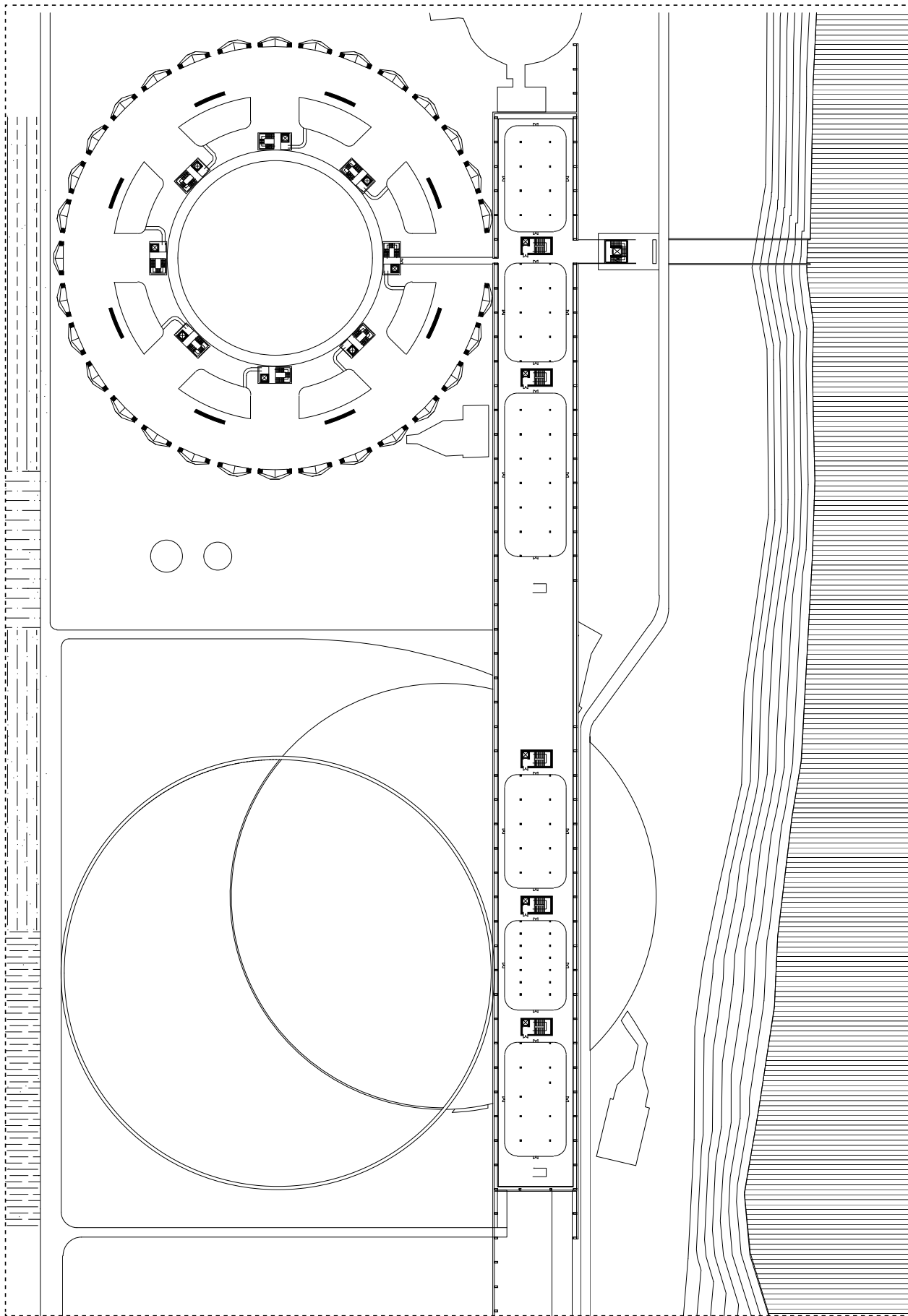

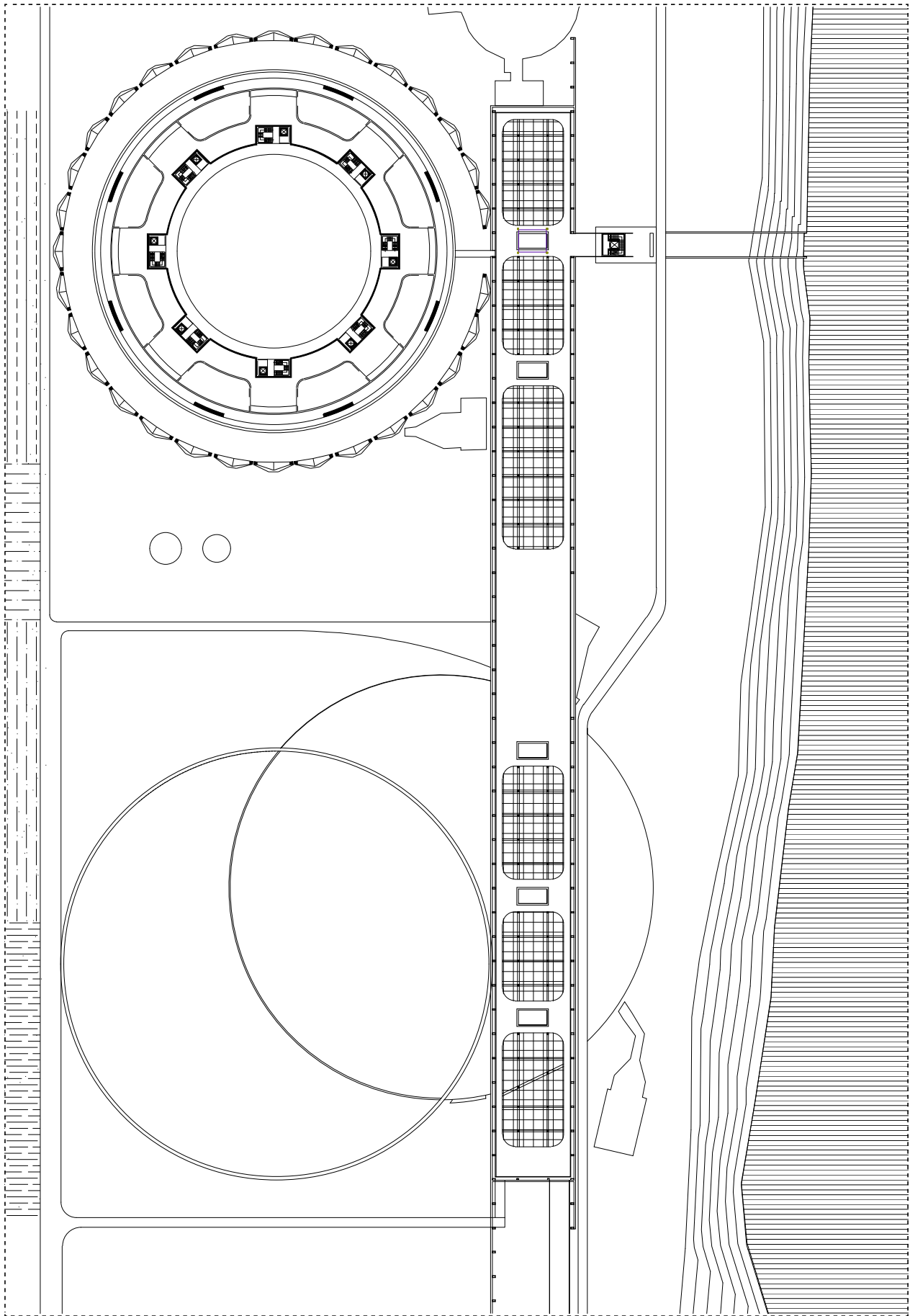

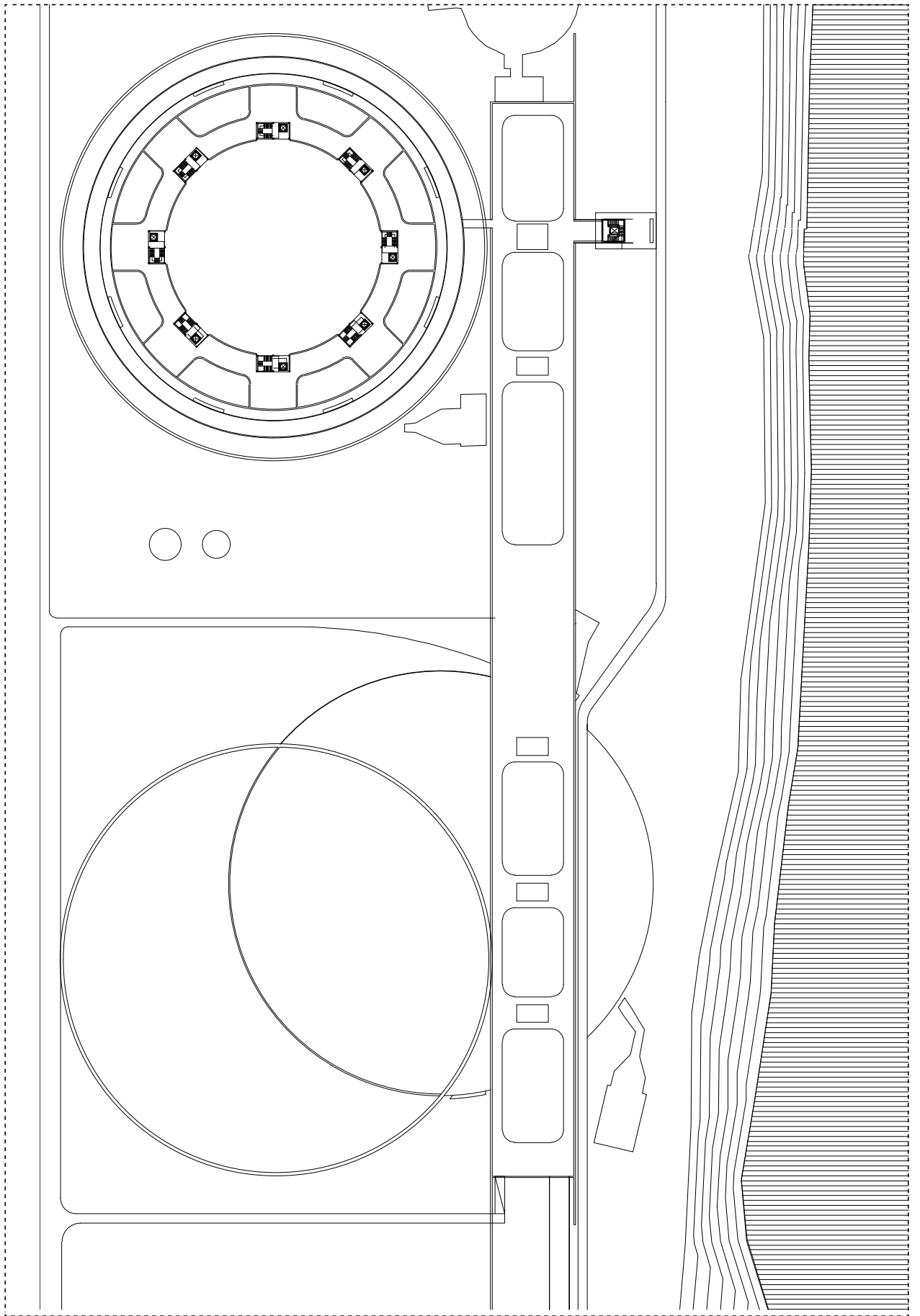

Building Technology Report

b.

Elevations & Sections

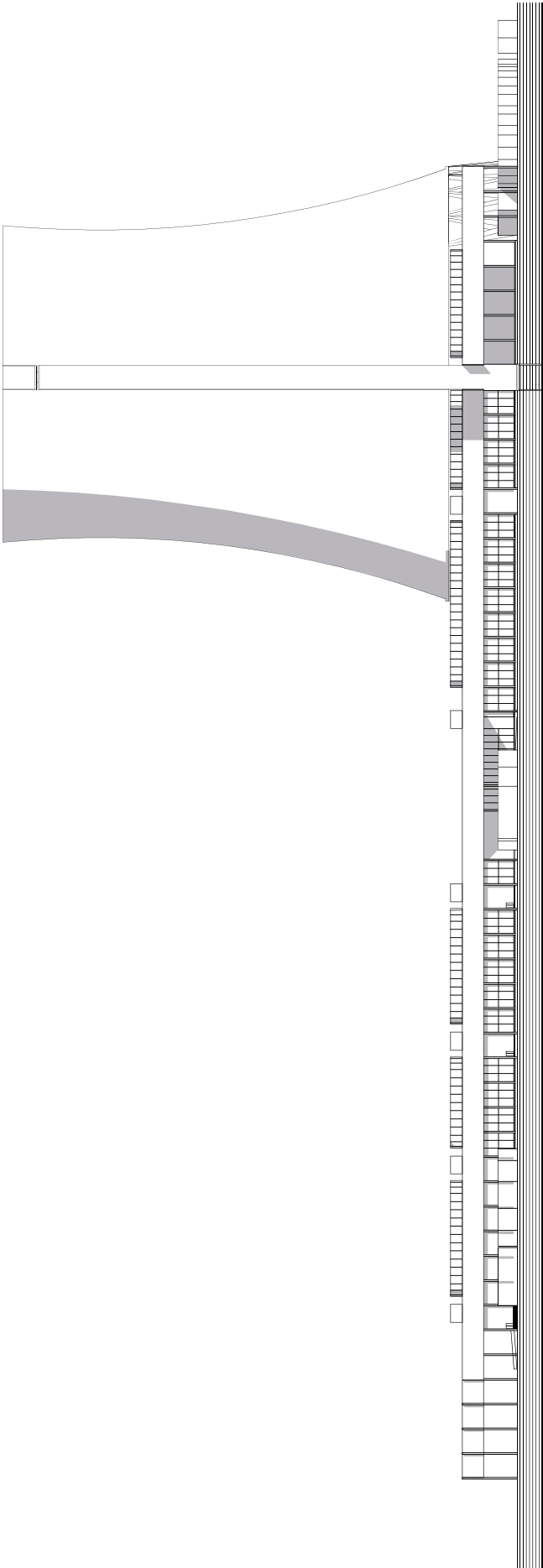

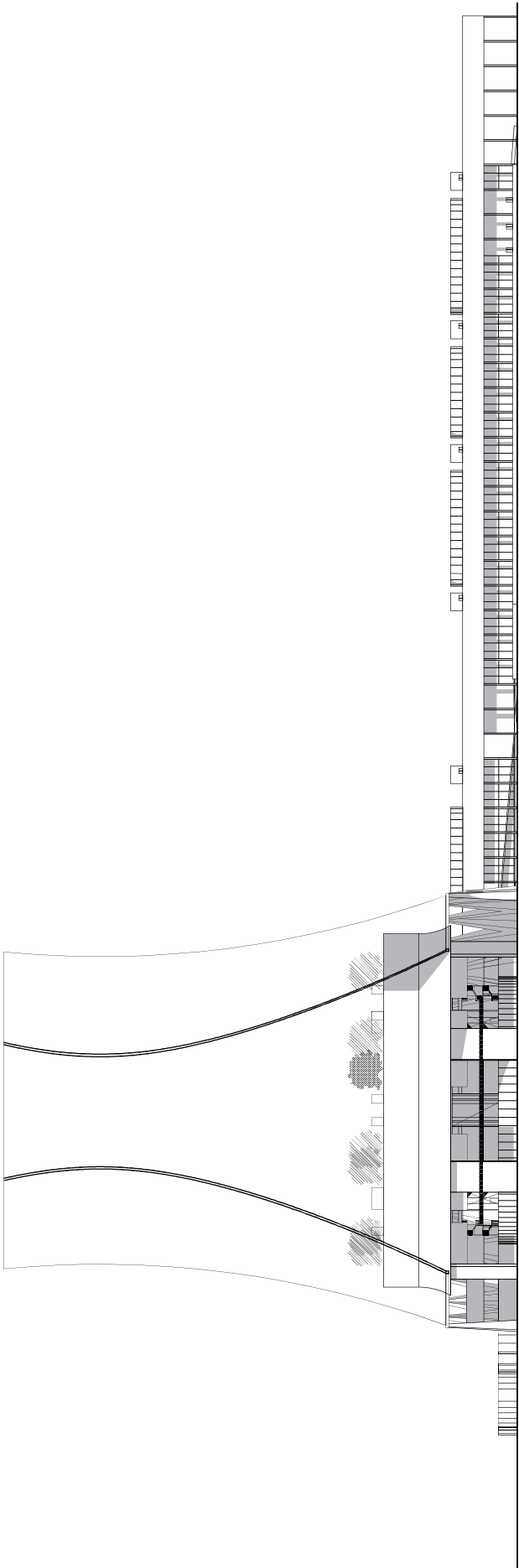

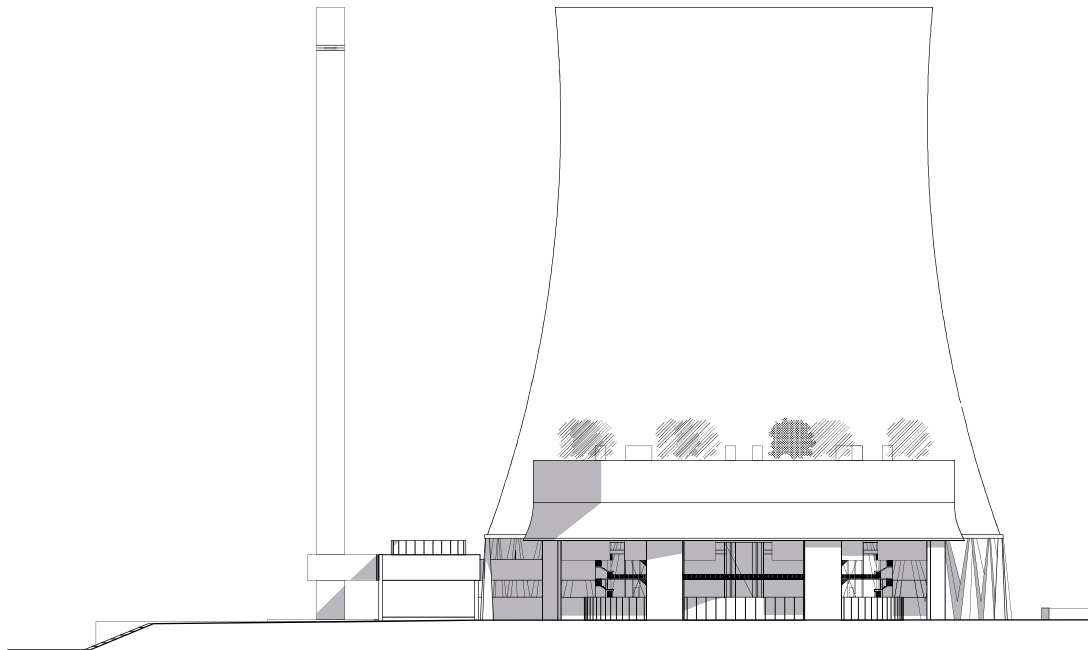
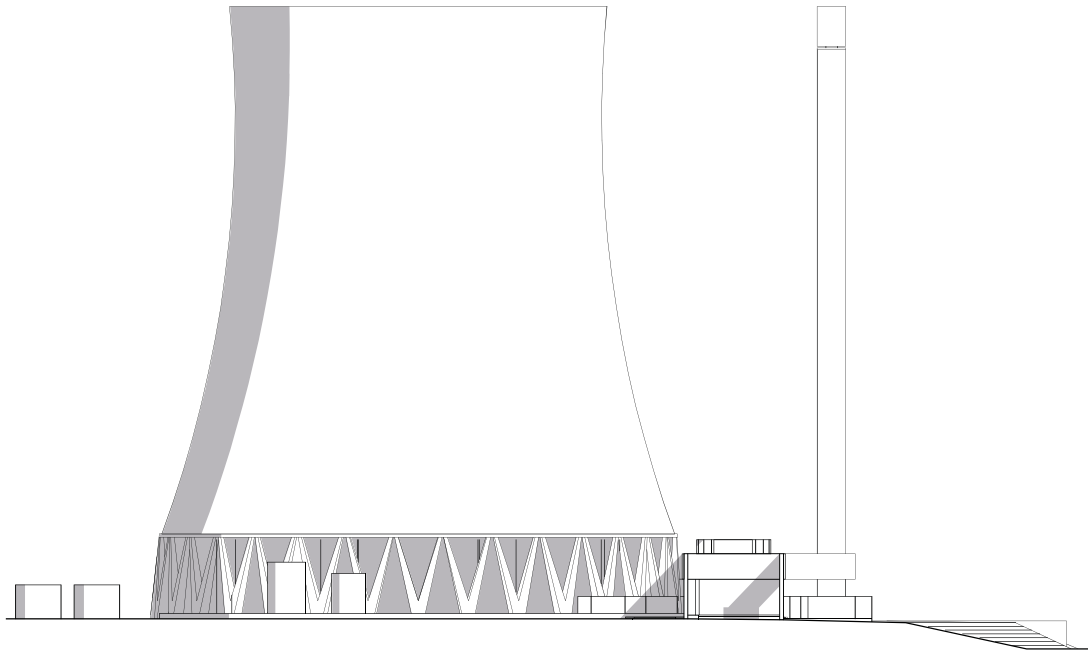

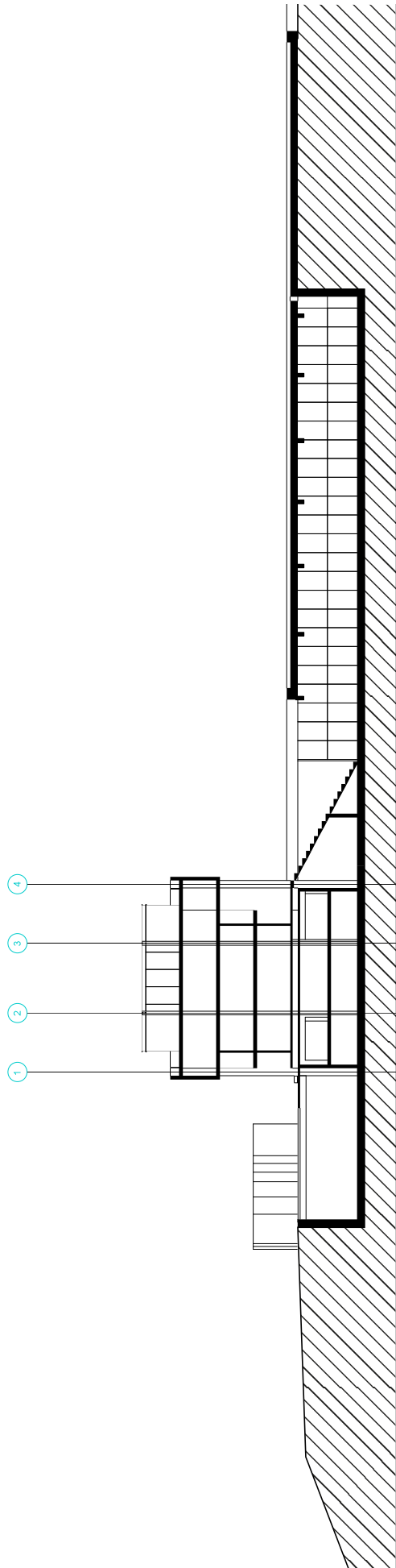

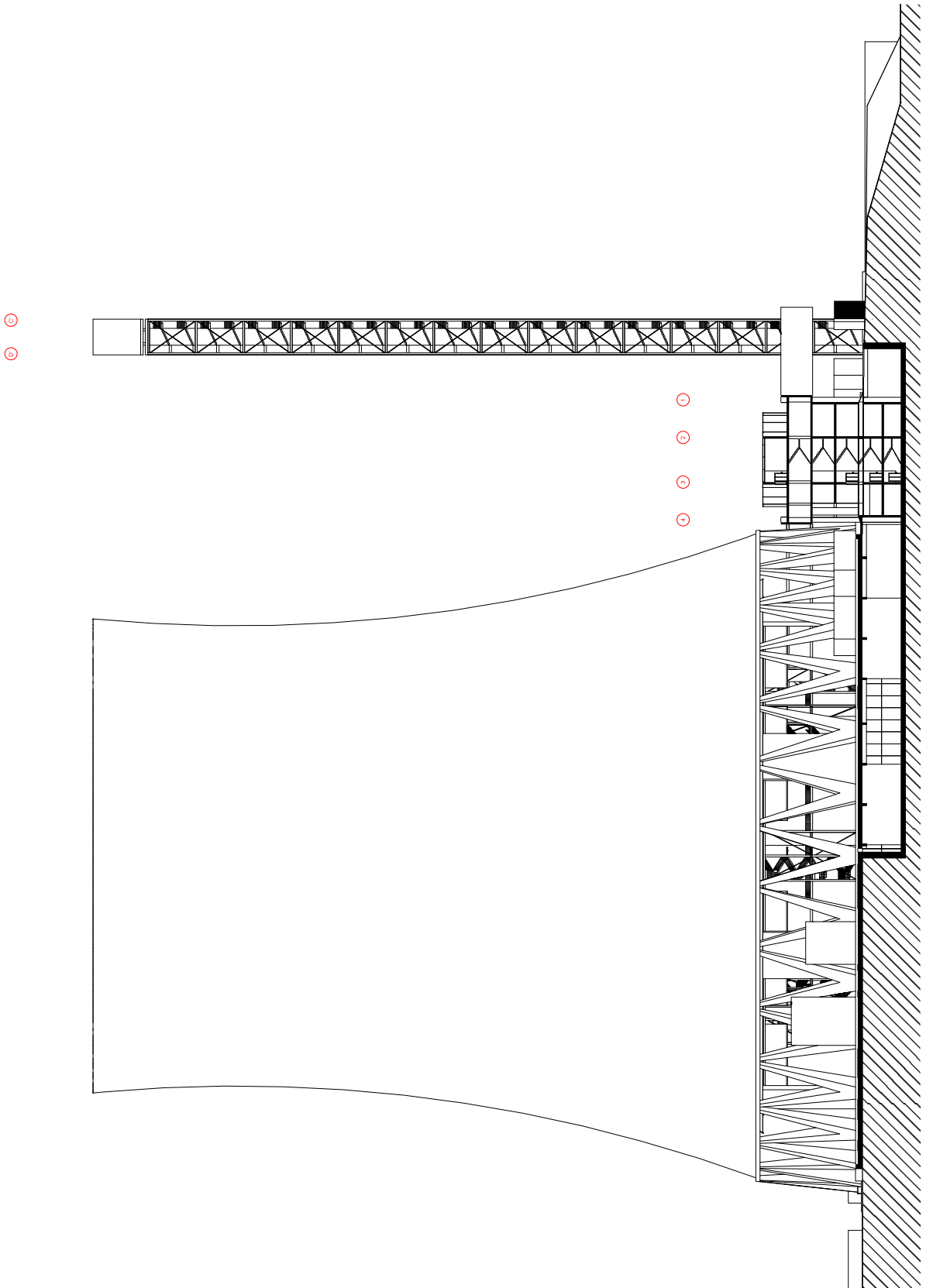

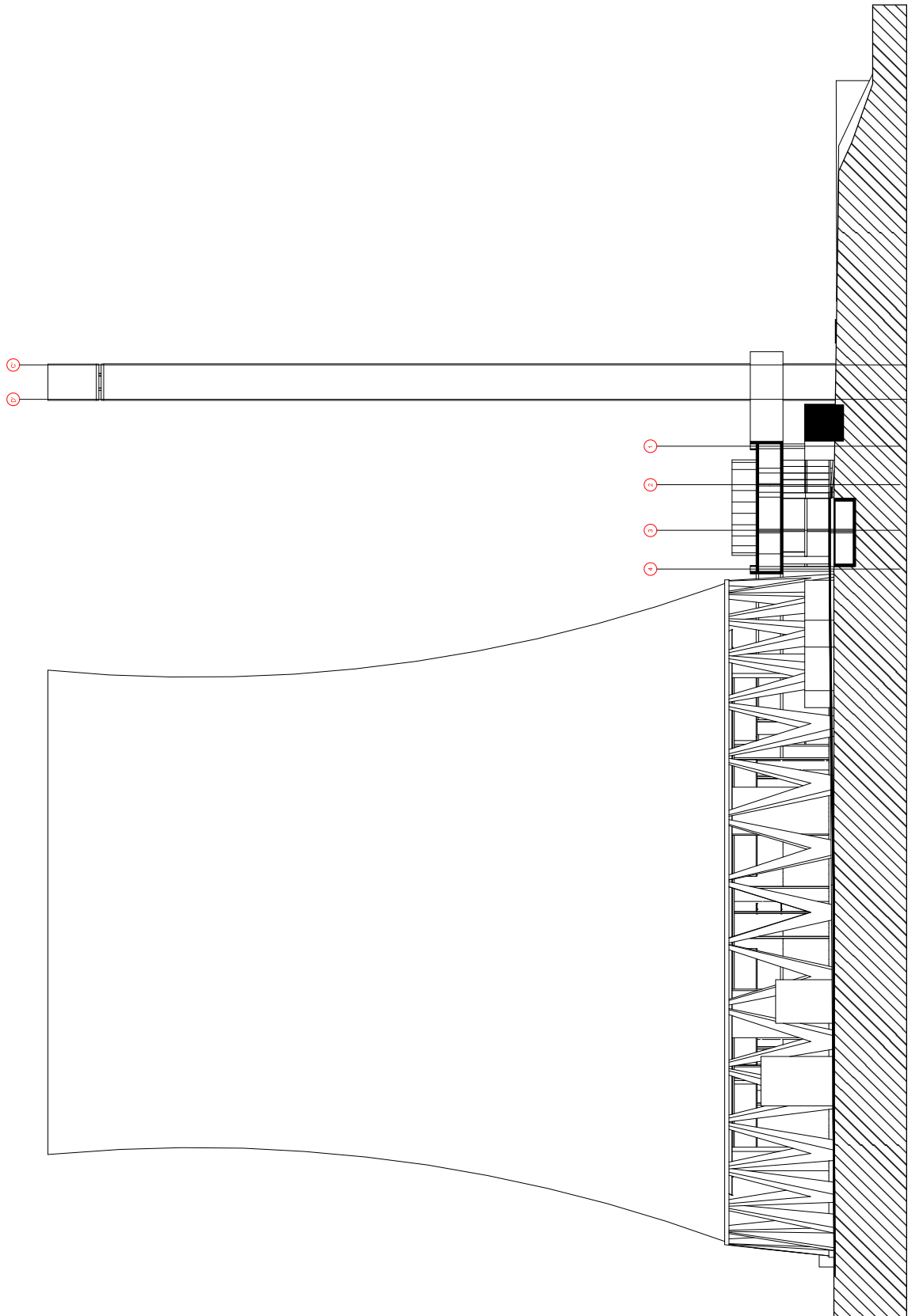

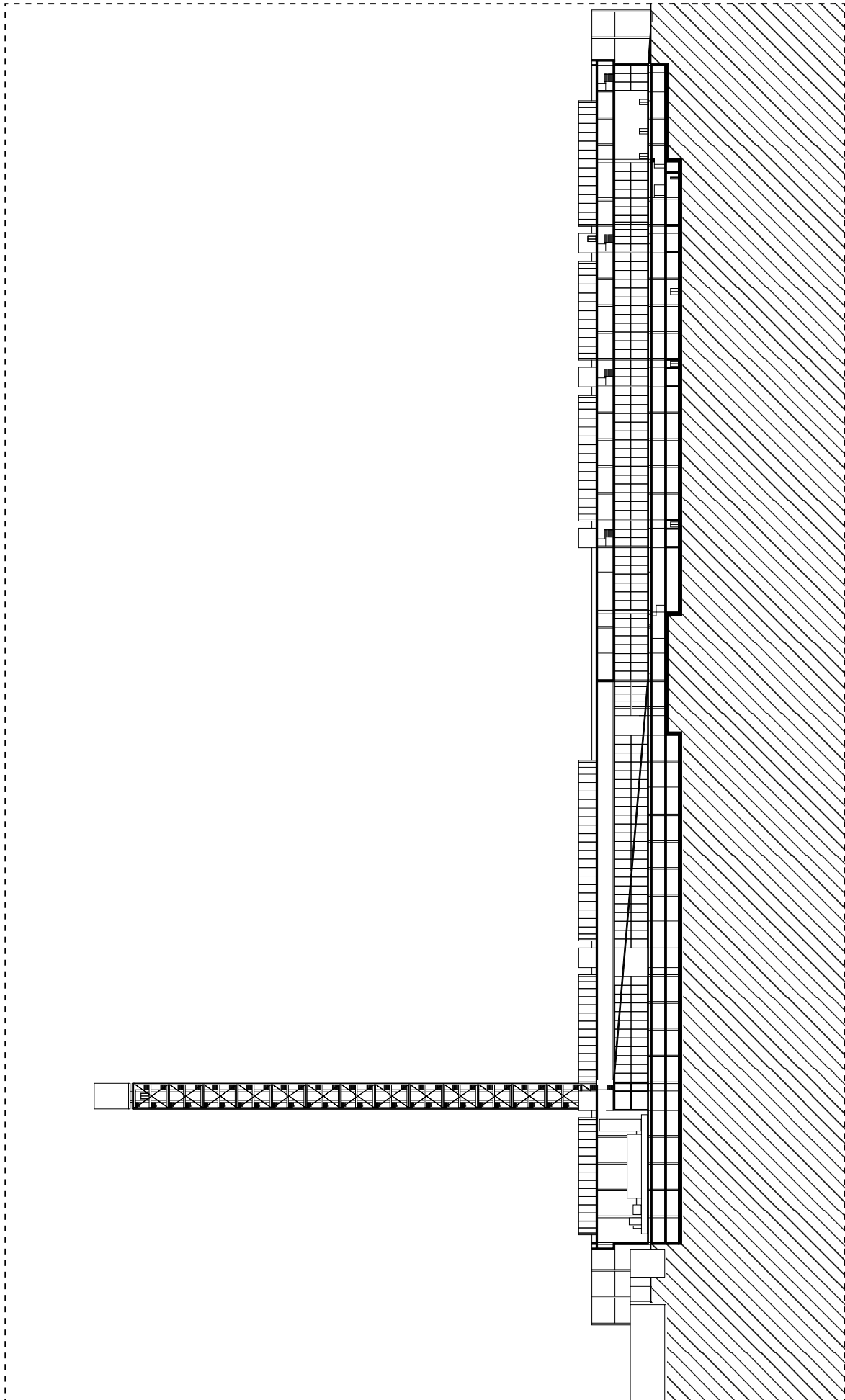

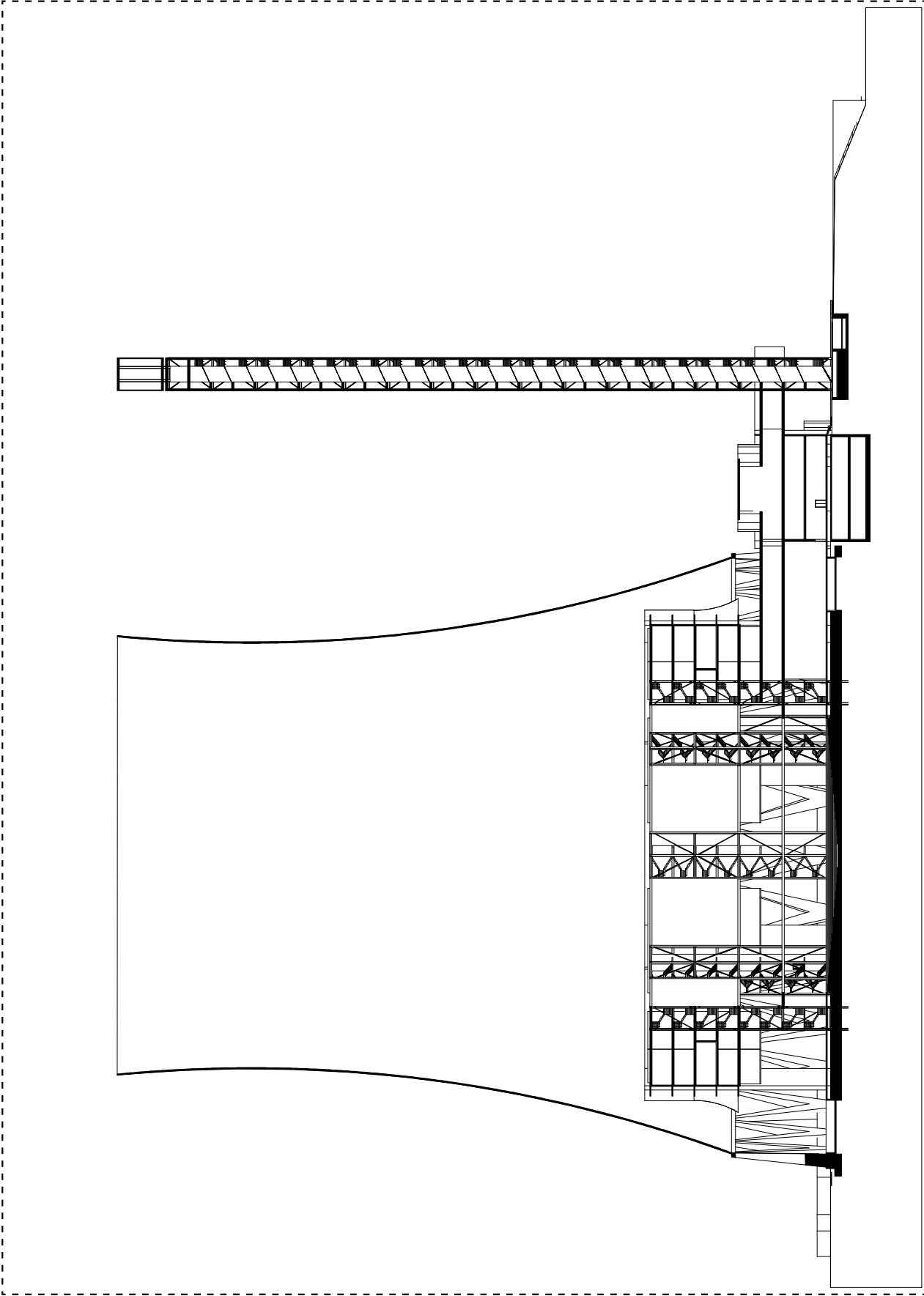

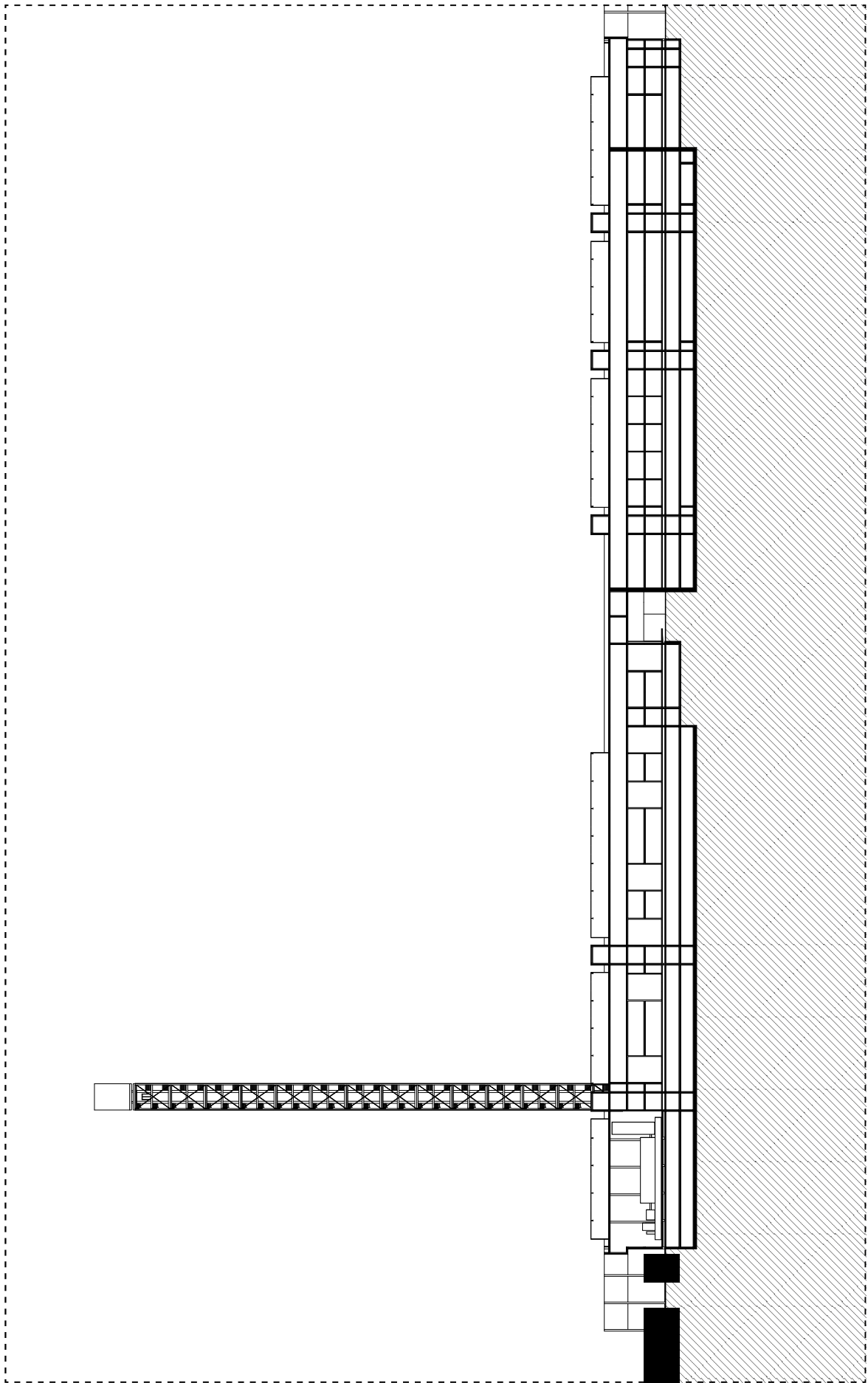

Research Report

IV.

Sources & Bibliography

Bibliography

- Osborn, Katherine (2017). *Seasonal Fish And Invertebrate Communities In Three Northern California Estuaries* (M.S. thesis). Humboldt State University.
- Ross, D. A. (1995). *Introduction to Oceanography*. New York: Harper Collins College Publishers.
- Pritchard, D. W. (1967). "What is an estuary: physical viewpoint". In Lauf, G. H. (ed.). *Estuaries*. A.A.A.S. Publ. 83. Washington, DC. pp. 3–5.
- McLusky, D. S.; Elliott, M. (2004). *The Estuarine Ecosystem: Ecology, Threats and Management*. New York: Oxford University Press
- Boswell, J., (2016). *Notes from the Wasteland: Competing Climatic Imaginaries in the Post-Apocalyptic Landscape*. In: Graham, J., Blanchfield, C., Anderson, A., Carver, J., & Moore, J., (2016). *Climates: Architecture and the Planetary Imaginary*, Lars Muller Publishers. pp.41-50.
- González Vives, C., (2016). *Dehydrated Architecture*. In: Graham, J., Blanchfield, C., Anderson, A., Carver, J., & Moore, J., (2016). *Climates: Architecture and the Planetary Imaginary*, Lars Muller Publishers. pp.329-337.
- Graham, J., Blanchfield, C., Anderson, A., Carver, J., & Moore, J., (2016). *Climates: Architecture and the Planetary Imaginary*, Lars Muller Publishers.
- Keenan, J. M., (2016). *The Resilience Problem: Part 1*. In: Graham, J., Blanchfield, C., Anderson, A., Carver, J., & Moore, J., (2016). *Climates: Architecture and the Planetary Imaginary*, Lars Muller Publishers. pp.159-162.
- Keenan, J. M., (2014). *Material and Social Construction: A Framework for the Adaptation of Buildings*. In: *Enquiry: Journal of Architectural Research*, vol.11, no.1.
- Alberti, M., (2016). *Cities That Think like Planets. Complexity, Resilience, and Innovation in Hybrid Ecosystems*, University of Washington Press.
- Grosz, E. (2013). *Time Matters: On Temporality in the Anthropocene: Elizabeth Grosz in Conversation with Heather Davis and Etienne Turpin*. In: Turpin, E., (2013). *Architecture in the Anthropocene: Encounters Among Design, Deep Time, Science and Philosophy*, Open Humanities Press.
- White, I., & O'Hare, P. (2014). *From Rhetoric to Reality: Which Resilience, Why Resilience, and Whose Resilience in Spatial Planning? Environment and Planning C: Government and Policy*, 32(5), 934–950.
- Wu, J. & Wu, T., (2013). *Ecological Resilience as a Foundation for Urban Design and Sustainability*. In: Pickett S., Cadenasso M., McGrath B. (eds) *Resilience in Ecology and Urban Design*. Future City, vol 3. Springer.
- Laboratories:
 D. Grömling, H. Braun, H. Bleher (2005). *Research and Technology Buildings: A Design Manual*. Birkhäuser
- L.J. DiBerardinis, J.S. Baum, M.W. First, G.T. Gatwood, A.K. Seth (2013). *Guidelines for Laboratory Design: Health, Safety, and Environmental Considerations, 4th edition*. Wiley

Images

pg. 17

Image retrieved from <https://www.corriere.it/salute/cards/ibernazione-umana-come-funziona-dove-si-puo-fare/ci-si-puo-ibernare-vivi.shtml?soAt=>

Image retrieved from <https://twitter.com/garethbarlow/status/999618580743426049>

Cartography

Cartography: edited by author from Transitional Territories Studio Atlas (2019-2020)

Base Map:

EA. (2002). Soil type. Retrieved 09-10-2019, from: <https://www.eea.europa.eu/data-and-maps/data/soil-type>. Modified by authors in qGIS.

Bathymetry:

GEBCO. (n.k.). Global grid. Retrieved 10-10-2019, from: <https://www.gebco.net/>. Modified by authors in qGIS.

Floodings NL:

Nederland Waterland. (n.k.). Watersnoodramp 1953.

Retrieved 23-10-2019, from: <https://sites.google.com/site/nederwaterlandje/pakketten>. Image traced by authors in illustrator.

Alferi, L., Burek, P., Feyen, L., and Forzieri, G. (2015). Global warming increases the frequency of river floods in Europe, *Hydrol. Earth Syst. Sci.*, 19, 2247–2260, <https://doi.org/10.5194/hess-19-2247-2015>, 2015.

Rivers discharging into North Sea, catchment areas:

EEA. (2001). Eutrophication in Europe's coastal waters. Retrieved 12-11-19, from: https://www.eea.europa.eu/Topic_Report_7_2001

EEA. (2012). European catchments and Rivers network system (Ecrins). Retrieved 23-10-2019, from: <https://www.eea.europa.eu/data-and-maps/data/european-catchments-and-rivers-network#tab-gis-data>
Modified by authors in qGIS.

Qw. (2019). List of rivers discharging into the North Sea. Retrieved 10-10-19, from: https://nl.qwertyu.wiki/wiki/List_of_rivers_discharging_into_the_North_Sea

Currents, Water masses & dispersal Fluvial Waters:

Laevastu, T (1983) Scnal atlas of the marine environment .Vol 4 Am Geogr Soc, New York

Otto, L , Zimmerman, J T F . futnes, G K, Mork,

M , Saetre, R, Becker, G. (1990). Review of physical oceanography of the North Sea. *Neth J Sea Res* 76(2-4), p 161-238

Connolly, P. L., Kelly, E., Dransfeld, L., Slattery, N., Paramor, O. A. L., & Frid, C. L. J. (2009). MEFEPO North Sea Atlas: Making the European Fisheries Ecosystem Plan Operational. Liverpool: University of Liverpool.

ICONA (1992). North Sea atlas for Netherlands policy and management. Amsterdam: Stadsuitgeverij Amsterdam.

Seabed sediments:

Van Alphen, J.S.L.J. (1990). A mud balance for Belgian-Dutch coastal waters between 1969 and 1986. *Neth. J. Sea Res.* 25 (1/2), p. 19-30. Eisma, D., Irion, C. (1988). Suspended matter and sediment transport. In: Salomons, W., Bayne, B.L., Duursma, E.K., Förstner, U. (eds.).

Anthropogenic agents:

Gill, J., Malamud, B. (2017). Anthropogenic processes, natural hazards, and interactions in a multi-hazard framework. *Earth-Science Reviews*. 166. 10.1016/j.earscirev.2017.01.002.

Waddenbied. (2019). Terpen. Retrieved 13-10-19, from: http://www.waddenzeeschool.nl/uploads/encyclopediedata/content-waddenbieb.php?template=template-waddenbieb&language=0&online=0&keep_empty_divs=0&title_inside_lead=0&edit=0&cid=3180&item=Terpen

Soil biodiversity loss & intensive human exploitation:

Orgiazzi, A., Panagos, P., Yigini, Y., Dunbar, M. B., Gardi, C., Montanarella, L., & Ballabio, C. (2016). A knowledge-based approach to estimating the magnitude and spatial patterns of potential threats to soil biodiversity. *Science of the Total Environment*, 545, 11-20.

Timeline events:

Rijkswaterstaat (n.k.). De Deltawerken. Retrieved 02-10-2019, from: <https://www.rijkswaterstaat.nl/water/waterbeheer/bescherming-tegen-het-water/waterkeringen/deltawerken/index.aspx>

Maione, U., Majone-Lehto, B., & Monti, R. (Eds.). (2000). *New trends in water and environmental engineering for safety and life*. Rotterdam: CRC Press.

Gov.UK (2014). The Thames Barrier. Retrieved 02-10-2019, from: <https://www.gov.uk/guidance/the-thames-barrier>

KNMI (n.k.). Watersnoodramp 1953. Retrieved 02-10-2019, from: <https://www.knmi.nl/kennis-en-datacentrum/achtergrond/watersnoodramp-1953>

Mauch, F. (2012). The great flood of 1962 in Hamburg. *Environment & Society Portal*, Arcadia, no. 6.

Encyclopaedia Britannica (2019). Battle of Jutland. Retrieved 02-10-2019, from: <https://www.britannica.com/event/Battle-of-Jutland>

Encyclopaedia Britannica (2019). The war at sea, 1914-15. Retrieved 02-10-2019, from: <https://www.britannica.com/event/World-War-I/The-war-at-sea-1914-15>

Tucker, S.C. (2016). *World War II: The Definitive Encyclopedia and Document Collection*. California: ABC-CLIO

NorthSee (n.k.). The history of shipping of the North Sea. Retrieved 02-10-2019, from: <https://northsearegion.eu/northsee/s-hipping/the-history-of-shipping-of-the-north-sea/>

Officer of the watch (2013). Alexander L. Kielland Platform capsized accident - investigation report. Retrieved 02-10-2019, from: <https://officerofthewatch.com/2013/04/29/alexander-l-kielland-platform-capsized-accident/>

Macleod, F. and Richardson, S. (2018). Piper Alpha: The Disaster in Detail. Retrieved 02-10-2019, from: <https://www.thechemicalengineer.com/features/piper-alpha-the-disaster-in-detail/>

5m elevation contour line:

CRISIS (n.k.). 5 Meter Inundation. Haskell Indian Nations University. Retrieved 8-10-2019, from: <http://cdn.antarcticglaciers.org/wp-content/uploads/2013/07/euro-sea-ice2.jpg>

EEA. (2002). Five meter elevation contour line. Retrieved 8-10-2019, from: <https://www.eea.europa.eu/data-and-maps/data/five-meter-elevation-contour-line>
Modified by authors in qGIS.

Population and ports:

ArcGIS Hub. (2018). World cities - population. Downloaded 10-10-2019, from: https://hub.arcgis.com/datasets/6996f03a1b364dbab4008d99380370ed_0?geometry=-94.441%2C-66.873%2C97.512%2C82.375&selectedAttribute=POP
Modified by authors in qGIS.

Population growth:

Roser, M. (2019). Future Population Growth. Retrieved 23-10-2019, from: <https://ourworldindata.org/future-population-growth>

Roser, M., Ritchie, H. and Ortiz-Ospina, E. (2019). World Population Growth. Retrieved 23-10-2019, from: <https://ourworldindata.org/world-population-growth>

Climate change, Sea level rise & CO2 emissions:

IPCC (2014). Climate change 2014: Synthesis Report. Retrieved 23-10-2019, from: https://ar5-syr.ipcc.ch/ipcc/resources/pdf/IPCC_SynthesisReport.pdf

National Oceanic and Atmospheric Administration (2017). Global and regional sea level rise scenarios for the United States. Retrieved: 23-10-2019, from: https://tidesandcurrents.noaa.gov/publications/techrpt83_Global_and_Regional_SLR_Scenarios_for_the_US_final.pdf

NSIDC (2019). Facts about glaciers. Retrieved 02-10-2019, from: <https://nsidc.org/cryosphere/glaciers/quickfacts.html>

Briney A. (2019, July 27th). An Overview of the Last Global Glaciation. Retrieved 02-10-2019, from: <https://www.thoughtco.com/the-last-glaciation-1434433>

Labeyrie L.D., Duplessy J.C. and Blanc P.L. (1987). Variations in mode of formation and temperature of oceanic deep waters over the past 125,000 years. *Nature* Vol. 327, p. 477-482.

Storms J. (2019). Towards a +3 m rise in sea level: planned strategies or Russian Roulette? Powerpoint presentation. SLIKC – Sea level Impact Knowledge Collective, TU Delft, delivered 27 September 2019.

Salinity and Pollution:

A 2D hydrodynamic model of the Scheldt estuary in 1955 to assess the ecological past of the estuary.

https://www.researchgate.net/publication/256987996_A_2D_hydrodynamic_model_of_the_Scheldt_estuary_in_1955_to_assess_the_ecological_past_of_the_estuary

Waasland History Evolution:

Edited by author on I. Jongpier maps in “*Excursion Waasland Scheldt polders and Land van Saeftinghe*” (March 19, 2013) by Iason Jongepier^{1,3}, Katrien Heirman¹, Tine Missiaen¹ & Peter Vos²

“Not all those who wander are lost”

Luca Parlangeli

Transitional Territories Studio - 2019-2020

TU Delft

Architecture

