

Orbits of N-expansions with a finite set of digits

de Jonge, C.J.; Kraaikamp, Cor; Nakada, Hitoshi

DOI

[10.1007/s00605-021-01658-x](https://doi.org/10.1007/s00605-021-01658-x)

Publication date

2022

Document Version

Final published version

Published in

Monatshefte fur Mathematik

Citation (APA)

de Jonge, C. J., Kraaikamp, C., & Nakada, H. (2022). Orbits of N-expansions with a finite set of digits. *Monatshefte fur Mathematik*, 198(1), 79-119. <https://doi.org/10.1007/s00605-021-01658-x>

Important note

To cite this publication, please use the final published version (if applicable). Please check the document version above.

Copyright

Other than for strictly personal use, it is not permitted to download, forward or distribute the text or part of it, without the consent of the author(s) and/or copyright holder(s), unless the work is under an open content license such as Creative Commons.

Takedown policy

Please contact us and provide details if you believe this document breaches copyrights. We will remove access to the work immediately and investigate your claim.



Orbits of N -expansions with a finite set of digits

Jaap de Jonge¹ · Cor Kraaikamp² · Hitoshi Nakada³

Received: 1 February 2021 / Accepted: 23 November 2021
© The Author(s) 2022

Abstract

For $N \in \mathbb{N}_{\geq 2}$ and $\alpha \in \mathbb{R}$ such that $0 < \alpha \leq \sqrt{N} - 1$, we define $I_\alpha := [\alpha, \alpha + 1]$ and $I_\alpha^- := [\alpha, \alpha + 1)$ and investigate the continued fraction map $T_\alpha : I_\alpha \rightarrow I_\alpha^-$, which is defined as $T_\alpha(x) := \frac{N}{x} - d(x)$, where $d : I_\alpha \rightarrow \mathbb{N}$ is defined by $d(x) := \lfloor \frac{N}{x} - \alpha \rfloor$. For $N \in \mathbb{N}_{\geq 7}$, for certain values of α , open intervals $(a, b) \subset I_\alpha$ exist such that for almost every $x \in I_\alpha$ there is an $n_0 \in \mathbb{N}$ for which $T_\alpha^n(x) \notin (a, b)$ for all $n \geq n_0$. These *gaps* (a, b) are investigated using the square $\Upsilon_\alpha := I_\alpha \times I_\alpha^-$, where the *orbits* $T_\alpha^k(x)$, $k = 0, 1, 2, \dots$ of numbers $x \in I_\alpha$ are represented as cobwebs. The squares Υ_α are the union of *fundamental regions*, which are related to the cylinder sets of the map T_α , according to the finitely many values of d in T_α . In this paper some clear conditions are found under which I_α is gapless. If I_α consists of at least five cylinder sets, it is always gapless. In the case of four cylinder sets there are usually no gaps, except for the rare cases that there is one, very wide gap. Gaplessness in the case of two or three cylinder sets depends on the position of the endpoints of I_α with regard to the fixed points of I_α under T_α .

Keywords Continued fractions · Dynamical systems · Gaps

Mathematics Subject Classification Primary 11J70; Secondary 37E05

Communicated by H. Bruin.

✉ Jaap de Jonge
c.j.dejonge@uva.nl

Cor Kraaikamp
C.Kraaikamp@tudelft.nl

Hitoshi Nakada
nakada@math.keio.ac.jp

¹ Korteweg-de Vries Institute for Mathematics, Science Park 105-107, 1098 XG Amsterdam, The Netherlands

² Department of Electrical Engineering, Mathematics and Computer Science, Delft University of Technology, Mekelweg 4, 2628 CD Delft, The Netherlands

³ Department of Mathematics, Keio University, Yokohama 223-8522, Japan

1 Introduction

In 2008, Edward Burger and his co-authors introduced in [2] new continued fraction expansions, the so-called N -expansions, which are nice variations of the *regular continued fraction (RCF) expansion*. These N -expansions have been studied in various papers since; see [1,3,7]. In [8], a subclass of these N -expansions is introduced, for which the digit set is always finite. These particular N -expansions are defined as follows:

For $N \in \mathbb{N}_{\geq 2}$ and $\alpha \in \mathbb{R}$ such that $0 < \alpha \leq \sqrt{N} - 1$, let $I_\alpha := [\alpha, \alpha + 1]$ and $I_\alpha^- := [\alpha, \alpha + 1)$. Hereafter we denote by $\mathbb{N}_{\geq k}$ the set of positive integers $n \geq k$, while we write \mathbb{N} if $k = 1$. We define the N -expansion map $T_\alpha : I_\alpha \rightarrow I_\alpha^-$ (or I_α) as

$$T_\alpha(x) := \frac{N}{x} - d(x), \tag{1}$$

where $d : I_\alpha \rightarrow \mathbb{N}$ is defined by

$$d(x) := \left\lfloor \frac{N}{x} - \alpha \right\rfloor, \text{ if either } x \in (\alpha, \alpha + 1] \text{ or both } x = \alpha \text{ and } \frac{N}{\alpha} - \alpha \notin \mathbb{Z}$$

and

$$d(\alpha) = \left\lfloor \frac{N}{\alpha} - \alpha \right\rfloor - 1, \text{ if } \frac{N}{\alpha} - \alpha \in \mathbb{Z}.$$

Note that if $\frac{N}{\alpha} - \alpha \in \mathbb{Z}$, we have that $T_\alpha(\alpha) = \alpha + 1$. This is the only case in which the range of T_α is I_α and not I_α^- .

For a fixed $\alpha \in (0, \sqrt{N} - 1]$ and $x \in I_\alpha$ we define for $n \in \mathbb{N}$

$$d_n = d_n(x) := d(T_\alpha^{n-1}(x)).$$

Note that for $\alpha \in (0, \sqrt{N} - 1]$ fixed, there are only *finitely* many possibilities for each d_n .

Applying (1), we obtain for every $x \in I_\alpha$ a continued fraction expansion of the form

$$x = T_\alpha^0(x) = \frac{N}{d_1 + T_\alpha(x)} = \frac{N}{d_1 + \frac{N}{d_2 + T_\alpha^2(x)}} = \dots = \frac{N}{d_1 + \frac{N}{d_2 + \frac{N}{d_3 + \dots}}}, \tag{2}$$

which we will throughout this paper write as $x = [d_1, d_2, d_3, \dots]_{N,\alpha}$ (note that this expansion is infinite for every $x \in I_\alpha$, since $0 \notin I_\alpha$); we will call the numbers $d_i, i \in \mathbb{N}$, the *partial quotients* or *digits* of this N -continued fraction expansion of x ; see [3,8],

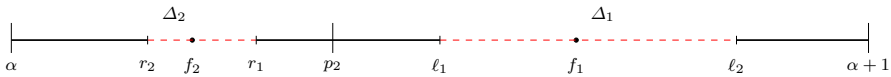

Fig. 1 $N = 51, \alpha = 6$

where these continued fractions (also with a finite set of digits) were introduced and elementary properties were studied (such as the convergence in reference [3]).

In each cylinder set $\Delta_i := \{x \in I_\alpha; d(x) = i\}$ of rank 1, with $d_{\min} \leq i \leq d_{\max}$, where $d_{\max} := d(\alpha)$ is the largest partial quotient, and $d_{\min} := d(\alpha + 1)$ the smallest one given N and α , the map T_α obviously has one fixed point f_i . As of now we will write simply ‘cylinder set’ for ‘cylinder set of rank 1’.

It is easy to see that¹

$$f_i = f_i(N) = \frac{\sqrt{4N + i^2} - i}{2}, \quad \text{for } d_{\min} \leq i \leq d_{\max}. \tag{3}$$

Note that $\frac{N}{\alpha} - \alpha \in \mathbb{Z}$ if and only if for some $d \in \mathbb{N}_{\geq 2}$ we have that $\alpha = f_{d+1}$, while for any $\alpha_0 \in [f_{d+2}, f_{d+1})$ we have that $\Delta_{d+1} \neq \emptyset$.

Given $N \in \mathbb{N}_{\geq 2}$, we let $\alpha_{\max} = \sqrt{N} - 1$ be the largest value of α we consider. The reason for this is that for larger values of α we would have 0 as a partial quotient as well. Since $T'_\alpha(x) = -N/x^2$ and because $0 < \alpha \leq \sqrt{N} - 1$, we have $|T'_\alpha(x)| > 1$ on I_α^- . From this it follows that the fixed points act as repellers and that the maps T_α are expanding if $0 < \alpha \leq \sqrt{N} - 1$. This is equivalent to the convergence of the N -expansion of all $x \in I_\alpha$.

Each pair of consecutive cylinders sets (Δ_i, Δ_{i-1}) is divided by a discontinuity point $p_i(N, \alpha)$ of T_α , satisfying $\frac{N}{p_i} - i = \alpha$, so $p_i = \frac{N}{\alpha+i}$. A cylinder set Δ_i is called full if $T_\alpha(\Delta_i) = I_\alpha^-$ (or I_α). If a cylinder set is not full, it contains either α (in which case $T_\alpha(\alpha) < \alpha + 1$) or $\alpha + 1$ (in which case $T_\alpha(\alpha + 1) > \alpha$), and is called incomplete. On account of our definition of T_α , cylinder sets will always be an interval, never consist of one single point.

The main object of this paper is the sequence $T_\alpha^n(x), n = 0, 1, 2, \dots$, for $x \in I_\alpha$, which is called the orbit of x under T_α . More specifically, we are interested in subsets of I_α that we will call gaps for such orbits. Before we will give a proper definition of ‘gap’, we will give an example of orbits of points in I_α for a pair $\{N, \alpha\}$. Note that, since the fixed points are repellent, orbits cannot remain in one cylinder set indefinitely if $x \in I_\alpha$ is not a fixed point of T_α , so any orbit will show an infinite migration between cylinder sets. A naive approach is to compute the orbits of many points of I_α and obtain a plot of the asymptotic behaviour of these orbits by omitting the first, say hundred, iterations. Figure 1 shows such a plot for $N = 51$ and $\alpha = 6$. It appears that there are parts of I_α (illustrated by dashed line segments) that are not visited by any orbit after many iterations of T_α .

In fact, setting $\ell_i = T_\alpha^i(\alpha)$ and $r_i = T_\alpha^i(\alpha + 1)$, the orbit of any point—apart from the fixed points f_1 and f_2 —after once having left the interval $(r_2, r_1) \subset \Delta_2$ or $(\ell_1, \ell_2) \subset \Delta_1$ of Fig. 1, will never return to it.

¹ For reasons of legibility we will usually omit suffices such as ‘(N)’, ‘(N, alpha)’ or ‘(N, d)’.

Fig. 2 $N = 51, \alpha = 6, x = 6.5$

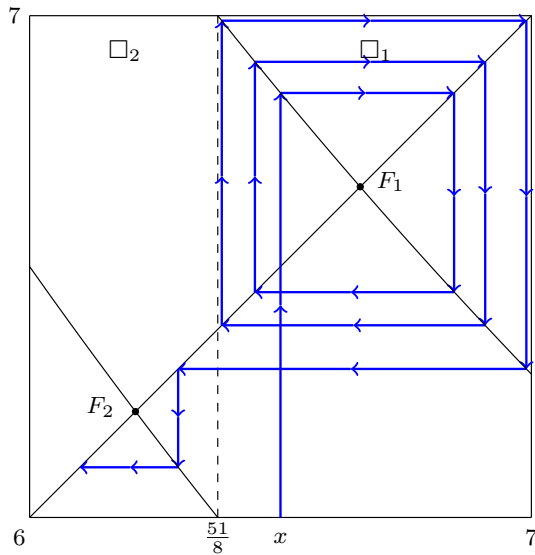

In order to get a better understanding of the orbits of N -expansions, it is useful to consider the graphs of T_α , which are drawn in the square $\mathcal{Y}_\alpha (= \mathcal{Y}_{N,\alpha}) := I_\alpha \times I_\alpha^-$. This square is divided in rectangular sets of points $\square_i := \{(x, y) \in \mathcal{Y}_\alpha : d(x) = i\}$, which are the two-dimensional *fundamental regions* associated with the one-dimensional cylinder sets we already use. We will call these regions in short *cylinders*. Now consider $(x, T_\alpha(x)) \in \mathcal{Y}_\alpha$. Then $(x, T_\alpha(x))$ goes to $(T_\alpha(x), T_\alpha^2(x))$ under T_α . Regarding this, T_α has one fixed point $F_i := (f_i, f_i)$ in each \square_i . We will denote the dividing line between \square_i and \square_{i-1} by l_i , which is the set $\{p_i\} \times [\alpha, \alpha + 1)$, with p_i the discontinuity point between Δ_i and Δ_{i-1} . In case $T_\alpha(\Delta_i) = I_\alpha^-$, we will call the cylinder \square_i *full* and the branch of the graph of T_α in \square_i *complete*; if a cylinder is not full, we will call it and its associated branch of T_α *incomplete*. We will call the collection of \mathcal{Y}_α and its associated branches, fixed points and dividing lines an *arrangement* of \mathcal{Y}_α . If \mathcal{Y}_α is a union of full cylinders, we will call the associated arrangement also full.

Figure 2 is an example of such an arrangement, in which a part of the *cobweb* is drawn associated with the orbit we investigated previously. The discontinuity point $p_2 = \frac{51}{8}$ is now visible as a dividing line between Δ_1 and Δ_2 .

In [3,8] the arrangement for $N = 4$ and $\alpha = 1$ is studied, consisting of two full cylinders \square_1 and \square_2 and not showing any gaps. On the other hand, the demonstration of the interval $(\frac{5}{2}, \frac{13}{5})$ being a gap of the interval $[2, 3]$ in the case $(N, \alpha) = (9, 2)$ in [8] is done without referring to such an arrangement. In this paper, and even more so in the next paper, we will show that arrangements may considerably support the insight in the occurrence of gaps.

We will now give a formal definition of gaps, which is slightly delicate, since $T_\alpha(I_\alpha) = I_\alpha^-$ (or I_α if $\frac{N}{\alpha} - \alpha \in \mathbb{Z}$).

Definition 1 A maximal open interval $(a, b) \subset I_\alpha$ is called a *gap* of I_α if for almost every $x \in I_\alpha$ there is an $n_0 \in \mathbb{N}$ for which $T_\alpha^n(x) \notin (a, b)$ for all $n \geq n_0$.

There are several papers where ‘gaps’ appear in number theoretic expansions. One of the first important examples is given by the so-called *negative β -expansion*, introduced and studied by Shunji Ito and Taizo Sadahiro [5]. For $\beta > 1$, let $I_\beta := \left[-\frac{\beta}{\beta+1}, \frac{1}{\beta+1} \right)$, and let the $(-\beta)$ -transformation $T_{-\beta} : I_\beta \rightarrow I_\beta$ be defined by

$$T_\beta(x) = -\beta x - \left\lfloor \frac{\beta}{\beta + 1} - \beta x \right\rfloor.$$

Ito and Sadahiro characterise the admissible sequences of $(-\beta)$ -expansions, give a necessary and sufficient condition for the $(-\beta)$ -shift to be sofic, and explicitly determine the invariant measure of the $(-\beta)$ -transformations. In their Example 18, Ito and Sadahiro also noticed the existence of gaps, as intervals where the density of the invariant measure is zero. In [11], Lingmin Liao and Wolfgang Steiner studied *negative β -expansions* defined on $[0, 1]$, which are conjugate to the negative β -expansions defined by Ito and Sadahiro. In [11] a complete classification of the gaps and of the mixing properties of these negative β -expansions is given. For maps slightly more general than the negative β -maps the reader is referred to Franz Hofbauer’s paper [4].

In Theorem 2 we show that there is a unique absolutely continuous invariant probability measure μ_α such that T_α is ergodic with respect to μ_α . As in [11] (for negative β -expansions), one also could define a gap as any interval in I_α where the density of μ_α is zero.

Remark 1 In the example of Fig. 1 the intervals (r_2, r_1) and (ℓ_1, ℓ_2) are gaps and for $x \in (r_2, r_1) \cup (\ell_1, \ell_2) \setminus \{f_1, f_2\}$ there exists an $n_0 = n_0(x)$ such that $T_\alpha^n(x) \notin (r_2, r_1) \cup (\ell_1, \ell_2)$ for $n \in \mathbb{N}_{\geq 2}$. The ‘for almost’² formulation in the definition of ‘gap’ is necessary so as to exclude fixed points and pre-images of fixed points, i.e. points that are mapped under T_α to a fixed point, which may never leave an gap. In Sect. 5 we even find a class of gaps (a, b) such that for uncountably many $x \in I_\alpha$ and all $n \in \mathbb{N} \cup \{0\}$ we have $T_\alpha^n(x) \in (a, b)$.

Remark 2 Whenever we use the word ‘gap’ in relation to arrangements, we mean the gap of the associated interval I_α .

In [8] computer simulations were used to get a more general impression of orbits of N -expansions. For a lot of values of α , plots such as Fig. 1 were stacked, for $0 < \alpha \leq \alpha_{\max}$, so as to obtain graphs such as Fig. 3, with the values of α on the vertical axis and at each height the corresponding interval I_α drawn. In the same paper, similar graphs are given for $N = 9, 20, 36$ and 100 . In all cases it appears that ‘gaps’ such as in Fig. 1 appear for values of α equal to or not much smaller than α_{\max} . Since the plots in [8] are based on computer simulations, they do not actually show very small gaps (smaller than pixel size) nor clarify much the connection between the gaps for each N . Still, the suggestion is strong that for α sufficiently small there are no gaps. It also seems that for α large enough several disjoint gaps may occur. In Fig. 3 we see this for α near $\alpha_{\max} = \sqrt{50} - 1$.

² All ‘for all’ statements in this paper are with respect to Lebesgue measure.

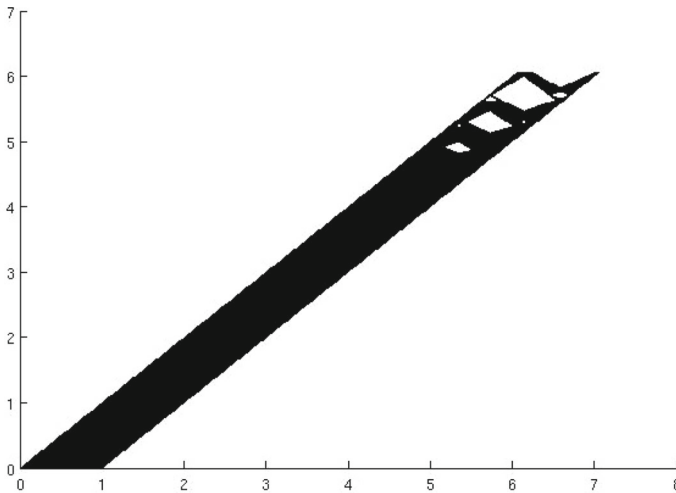

Fig. 3 A simulation of intervals I_α with gaps if existent, for $0 < \alpha \leq \sqrt{50} - 1$ and $N = 50$

In this paper we will not only investigate conditions for gaplessness, we will also show that simulations such as Fig. 3 fail to reveal the existence, for certain N and α , of one extremely large gap in plots such as Fig. 3 below the last visible gap. In a subsequent paper we will go into another very interesting property of orbits of N -expansions that is hardly revealed by simulations such as Fig. 3: the existence of large numbers of gaps for large N and α close to α_{\max} . But now we will concentrate on gaplessness.

Remark 3 If no gaps exist with non-empty intersection with a cylinder set, we call the cylinder set gapless.

In Sect. 2 we will consider two classes of arrangements that have no gaps: full arrangements and specific arrangements with more than three cylinders. The gaplessness of the latter class, involving the proof of Theorem 4, for which some preliminary results will be presented shortly, is largely given in Sect. 2, but involve some intricacies for small values of N so as to finish it at the end of this paper. In Sect. 3 we will consider arrangements with two cylinders and in Sect. 4 we will concentrate on arrangements with three cylinders, but will prove a sufficient condition for gaplessness that is valid for arrangements with any number of cylinders larger than 2. Finally, in Sect. 5 we will prove a result on gaps in certain arrangements with four cylinders and we will finish the proof of Theorem 4. After that, it is merely a matter of checking that for $N \in \{2, 3, 4, 5, 6\}$ all arrangements are gapless.

Although most results in this paper seem intuitively clear and obvious, our experience with these continued fraction maps is they are surprisingly unruly. The simulations from Fig. 3 may serve as an example that things are not what they always seem to be. From these simulations one might draw the (erroneous) conclusion that the number of gaps is at most 3. In a forthcoming paper we show however that the number of gaps is a function of N and α , and is growing larger and larger as N tends to infinity.

Although the proofs in this paper are often elementary, they require case distinctions and cumbersome calculations.

2 Full arrangements and arrangements with more than four cylinders

If I_α consists of full cylinder sets only, we obviously have no gaps. In this situation the mutual relations between N , α and $d(\alpha)$ show a great coherence, as expressed in the following theorem:

Theorem 1 *The interval I_α consists of m full cylinder sets, with $m \in \mathbb{N}_{\geq 2}$, if and only if there is a positive integer k such that*

$$\begin{cases} \alpha = k, \\ N = mk(k + 1), \\ d(\alpha) = (m - 1)(k + 1). \end{cases} \tag{4}$$

Proof of Theorem 1 Writing $d := d(\alpha)$, the interval I_α is the union of m full cylinder sets if and only if

$$\begin{cases} \frac{N}{\alpha} - d = \alpha + 1, \\ \frac{N}{\alpha + 1} - (d - m + 1) = \alpha. \end{cases} \tag{5}$$

Note that the first equation in (5) can be written as

$$N = \alpha^2 + (d + 1)\alpha,$$

while the second equation in (5) equals

$$N = \alpha^2 + (d + 2 - m)\alpha + d + 1 - m.$$

Subtracting the first of these equations from the last we find

$$\alpha = \frac{d + 1 - m}{m - 1}. \tag{6}$$

From (5), we have

$$\alpha = \frac{-(d + 1) + \sqrt{(d + 1)^2 + 4N}}{2}, \tag{7}$$

which yields that α is either a quadratic irrational or a rational number. Since (6) implies that α is a rational number we find that the integer $(d + 1)^2 + 4N$ must be a square, i.e. there exists a positive integer s such that $s^2 = (d + 1)^2 + 4N$. Note that d is an even integer if and only if s^2 is an odd integer if and only if s is an odd integer. Consequently we find that the numerator of α in (7) is *always* even, and (7) yields that α is a positive integer, say k . From the equations in (5) it follows that not only $\alpha = k$ but also $\alpha + 1 = k + 1$ is a divisor of N .

From the definition of T_α in (1) (especially the case $\frac{N}{\alpha} - \alpha \in \mathbb{Z}$) we see that

$$d = d(\alpha) = \frac{N}{k} - (k + 1). \tag{8}$$

On the other hand (6) yields that, since $\alpha = k$,

$$d = (m - 1)(k + 1),$$

and from this and (8) we see that

$$\frac{N}{k} - (k + 1) = (m - 1)(k + 1),$$

i.e. $N = mk(k + 1)$.

Conversely, let k be a positive integer such that the relations of (4) hold. Then both N/α and $N/(\alpha + 1)$ are positive integers, implying that *all* cylinder sets are full. Moreover, since $d = d(\alpha) = d_{\max}$ is given by

$$d = \frac{N}{\alpha} - \alpha - 1 = \frac{mk(k + 1)}{k} - k - 1 = (m - 1)(k + 1),$$

and $d_{\min} = d(\alpha + 1)$ is given by

$$d(\alpha + 1) = \left\lfloor \frac{N}{\alpha + 1} - \alpha \right\rfloor = mk - k = (m - 1)k,$$

it follows that there are

$$d_{\max} - (d_{\min} - 1) = (m - 1)(k + 1) - (m - 1)k + 1 = (m - 1) + 1 = m$$

full cylinder sets. □

Theorem 1 serves as a starting point for our investigation of orbits of N -expansions. The first thing we will do is give some preliminary results (in Sect. 2.1) that we need for proving (in Sect. 2.2) Theorem 3 and Theorem 4 on gaplessness of arrangements with at least five cylinders.

2.1 Preliminary results

The first thing to pay attention to is the way N and α and $d(\alpha)$, the value of the largest partial quotient, are interdependent, which is illustrated by the following lemmas:

Lemma 1 *Given N and α , let $d := d(\alpha)$ be the largest possible digit. Then*

$$d \geq N - 1 \text{ if and only if } \alpha < 1.$$

The proof of this lemma is left to the reader.

If $\alpha = \alpha_{\max} = \sqrt{N} - 1$, we have

$$d(\alpha) = \begin{cases} \left\lfloor \frac{2}{\sqrt{2}-1} - (\sqrt{2} - 1) \right\rfloor = 4 & \text{for } N = 2; \\ \left\lfloor \frac{3}{\sqrt{3}-1} - (\sqrt{3} - 1) \right\rfloor = 3 & \text{for } N = 3; \\ \left\lfloor \frac{4}{\sqrt{4}-1} - (\sqrt{4} - 1) \right\rfloor - 1 = 2 & \text{for } N = 4; \\ \left\lfloor \frac{N}{\sqrt{N}-1} - (\sqrt{N} - 1) \right\rfloor = \left\lfloor 2 + \frac{\sqrt{N}+1}{N-1} \right\rfloor = 2 & \text{for } N \in \mathbb{N}_{\geq 5}. \end{cases} \tag{9}$$

On the other hand we have, for $N \in \mathbb{N}, N \geq 2$ fixed:

$$\lim_{\alpha \downarrow 0} d(\alpha) = \lim_{\alpha \downarrow 0} \left\lfloor \frac{N}{\alpha} - \alpha \right\rfloor = \infty.$$

The following lemma provides for a lower bound for the rate of increase of $d(\alpha)$ compared with the rate of decrease of α .

Lemma 2 *Let $N \in \mathbb{N}_{\geq 2}$ be fixed and $d := d(\alpha)$. Then d is constant for $\alpha \in [f_{d+1}, f_d)$, and d increases overall more than twice as fast as α decreases.*

Proof of Lemma 2 Starting from α_{\max} , d increases by 1 each time α decreases beyond a fixed point, i.e. if $\frac{N}{\alpha} - \alpha \in \mathbb{N}$. For the difference between two successive fixed points f_{d-1} and f_d we have

$$\begin{aligned} f_{d-1} - f_d &= \frac{\sqrt{4N + (d-1)^2} - (d-1)}{2} - \frac{\sqrt{4N + d^2} - d}{2} \\ &= \frac{\sqrt{4N + (d-1)^2} - \sqrt{4N + d^2} + 1}{2} < \frac{1}{2}. \end{aligned}$$

This finishes the proof. □

Closely related to the previous lemma is the following one, the proof of which is left to the reader.

Lemma 3 *Let $d \in \mathbb{N}_{\geq 2}$ and $N \in \mathbb{N}_{\geq 2}$ be fixed and let $f_d(N)$ be defined by the equation $N/f_d(N) - d = f_d(N)$ (so $f_d(N)$ is the fixed point of the map $x \mapsto N/x - d$ for $x \in (0, N/d)$). Then*

$$f_{d-1}(N+1) - f_d(N+1) > f_{d-1}(N) - f_d(N).$$

So, for d fixed, the distance between two consecutive fixed points increases if N increases. We have, in fact, for d fixed:

$$\lim_{N \rightarrow \infty} (f_{d-1}(N) - f_d(N)) = \frac{1}{2};$$

cf. the proof of Lemma 2. For N fixed, on the other hand, we have:

$$\lim_{d \rightarrow \infty} f_d(N) = 0.$$

While $d(\alpha)$ is a monotonously non-increasing function of α , the number of cylinder sets is not. The reason is obvious: starting from $\alpha = \alpha_{\max}$, the number of cylinder sets changes every time either α or $\alpha + 1$ decreases beyond the value of a fixed point; in the first case, the number increases by 1, and in the second case, it decreases by 1. Since $T'_\alpha(x) = -N/x^2 < 0$ and $T''_\alpha(x) = 2N/x^3 > 0$ on I_α , $T_\alpha(x)$ is decreasing and convex on I_α , implying that a net increase of the number of cylinder sets. Still, for N and α large enough, it may take a long time of α decreasing from α_{\max} before the number of cylinder sets stops alternating between two successive numbers $k \in \mathbb{N}_{\geq 2}$ and $k + 1$, and starts to alternate between the numbers $k + 1$ and $k + 2$. As an example, we take $N = 100$. If α decreases from α_{\max} , the interval I_α consists of two cylinder sets until α decreases beyond f_3 and cylinder set Δ_3 emerges; then, if $\alpha + 1$ decreases beyond f_1 , cylinder set Δ_1 disappears and so on, until α decreases beyond f_8 and Δ_9 emerges while Δ_6 has not yet disappeared.

In order to get a grip on counting the number of cylinder sets, the following arithmetic will be useful: a full cylinder set counts for 1, an incomplete left one counts for $\frac{N}{\alpha} - d_{\max} - \alpha$, and an incomplete right one for $\alpha + 1 - (\frac{N}{\alpha + 1} - d_{\min})$, giving rise to the following definition:

Definition 2 Let $N \in \mathbb{N}_{\geq 2}$ and $\alpha \in \mathbb{R}$ such that $0 < \alpha \leq \sqrt{N} - 1$ and T_α the N -continued fraction map. The branch number³ $b(N, \alpha)$ is defined as

$$\begin{aligned} b(N, \alpha) := & d_{\max} - d_{\min} - 1 \text{ (the number of full cylinder sets save for the outermost ones)} \\ & + \frac{N}{\alpha} - d_{\max} - \alpha \text{ (the length of the image of the leftmost cylinder set)} \\ & + \alpha + 1 - \left(\frac{N}{\alpha + 1} - d_{\min} \right) \text{ (the length of the image of the rightmost cylinder set).} \end{aligned}$$

From this the next lemma follows immediately:

Lemma 4 For $N \in \mathbb{N}_{\geq 2}$ and $0 < \alpha \leq \sqrt{N} - 1$ we have

$$b(N, \alpha) = \frac{N}{\alpha} - \frac{N}{\alpha + 1} = \frac{N}{\alpha(\alpha + 1)}.$$

It follows that for fixed N the branch number $b(N, \alpha)$ is a strictly decreasing function of α .

Remark 4 Applying Lemma 4, we find

$$b(N, \alpha_{\max}) = \frac{N}{(\sqrt{N} - 1)\sqrt{N}} = 1 + \frac{1}{\sqrt{N} - 1}. \tag{10}$$

³ The word ‘branch’ refers to the part of the graph of T_α on the concerning cylinder set.

It follows that $b(N, \alpha) > 1$ for all $N \in \mathbb{N}_{\geq 2}$, so the number of cylinder sets is always at least 2. On the other hand, from Lemma 4 it follows that the number of cylinder sets increases to infinity as α decreases from α_{max} to 0. Actually, we have infinitely many digits *only* if $\alpha = 0$. In this case the corresponding N -expansion is the *greedy* N -expansion, studied in [1,3].

The relation $N/(\alpha(\alpha + 1)) = b$ yields

$$\alpha = \frac{\sqrt{\frac{4N}{b} + 1} - 1}{2}, \tag{11}$$

from which we derive that $d(\alpha) = d$ (or $d(\alpha) = d - 1$ in case $\frac{N}{\alpha} - \alpha \in \mathbb{Z}$), where d is given by

$$d = \left\lfloor \frac{(b - 1)\sqrt{\frac{4N}{b} + 1} + b + 1}{2} \right\rfloor. \tag{12}$$

2.2 Gaplessness if the branch number is large enough

So far, we merely discussed the way I_α is divided in cylinder sets, depending on the values of $N, \alpha, d(\alpha)$ and the branch number b . In order to present some first results on sufficient conditions for gaplessness, we will zoom in on some ergodic properties of T_α .

Lemma 5 *If μ is an absolutely continuous invariant probability measure for T_α , then there exists a function h of bounded variation such that*

$$\mu(A) = \int_A h \, d\lambda, \quad \lambda - a.e., \quad \text{with } \lambda \text{ the Lebesgue measure,}$$

i.e. any absolutely continuous invariant probability measure has a version of its density function of bounded variation.

Proof of Lemma 5 Since $\inf |T'_\alpha| > 1$, applying Theorem 1 from [9] immediately yields the assertion. □

Theorem 2 *Let $N \in \mathbb{N}_{\geq 2}$. Then there is a unique absolutely continuous invariant probability measure μ_α such that T_α is ergodic with respect to μ_α .*

Proof⁴ of Theorem 2 Let μ_α be a unique absolutely continuous invariant probability measure for T_α and choose its density function h of bounded variation. Then there exists an open interval J such that $h(x) > 0$ for any $x \in J$, since h has at most countably many discontinuity points. Consider $\{T^n J : n \geq 0\}$. Since $\inf |T'| > 1$, there exists an n_0 such that $T^{n_0}(J)$ includes a discontinuity point. (If necessary we may choose endpoints of J not in the preimages of discontinuity points of T_α .) We note that for

⁴ see also page 185, Theorem 1 in [10].

any measurable subset $A \subset J$ with $\mu_\alpha(A) > 0$ equivalently $\lambda(A) > 0$, $\mu(T^n A) > 0$ for any $n \geq 1$. Now $T^{n_0+1}(J)$ includes two intervals J_ℓ and J_r attached to α and $\alpha + 1$ respectively. For any measurable subset $B_0 \subset J_\ell \cup J_r$ of positive λ -measure, $\mu(B_0) > 0$, since otherwise we have a contradiction; $\mu(B_0) = 0$ and $\mu(T^{-(n_0+1)}(B_0)) > 0$ (since there is a $B_1 \subset J$ such that $T^{n_0+1}(B_1) = B_0$, $\mu(B_1) > 0$). This shows that any two absolutely continuous invariant probability measures μ_1 and μ_2 cannot have disjoint supports (i.e. they cannot be singular to each other), which is equivalent to the uniqueness of the absolutely continuous invariant probability measure and hence its ergodicity. \square

The next result follows directly from Theorem 2:

Corollary 1 *If iteration of T_α maps all open subintervals of I_α to the interval I_α^- , then I_α contains no gaps.*

Proof of Corollary 1 The assumption implies that the absolutely continuous invariant probability measure μ_α is equivalent to the Lebesgue measure, which implies that for any measurable subset $A \subset I_\alpha$, $\mu(A) = 0$ if and only if $\lambda(A) = 0$. Suppose that there is a gap J . Since J is an open interval, we have $\lambda(J) > 0$, thus $\mu(J) > 0$. Since $\mu(I_\alpha) < \infty$ implies a.e. $x \in J$, there exists infinitely many positive integers n such that $T^n(x) \in J$ (by the Poincaré recurrence theorem), which contradicts the assumption that there is a gap. \square

Before we present the first of two theorems on gaplessness, we note that in the case $N = 2$, the condition $|T'_\alpha(x)| > 2$ for all $x \in I_\alpha$ is not satisfied for any $\alpha \in (0, \sqrt{2}-1]$.

Theorem 3 *Let $N \in \mathbb{N}_{\geq 3}$, and let $0 < \alpha \leq \sqrt{N}-1$. Let $|T'_\alpha(x)| > 2$ for all $x \in I_\alpha$. Then I_α contains no gaps.*

Proof of Theorem 3 The condition implies $N/(\alpha + 1)^2 > 2$, yielding $\alpha < \sqrt{N/2}-1$. From Lemma 4 it follows that

$$b(N, \alpha) > \frac{2\sqrt{2N}}{\sqrt{2N}-2},$$

which is larger than 2 for all $N \in \mathbb{N}_{\geq 3}$. So I_α consists of at least three cylinder sets. Since $|T'_\alpha(x)| > 2$ for all $x \in I_\alpha$, there exists an $\varepsilon > 0$ such that for any open interval J_0 that is contained in a cylinder set of T_α we have

$$|T_\alpha(J_0)| \geq (2 + \varepsilon)|J_0|,$$

where $|J|$ denotes the length (i.e. Lebesgue measure) of an interval J .

If $T_\alpha(J_0)$ contains two consecutive discontinuity points p_{i+1}, p_i of T_α , then

$$(p_{i+1}, p_i) \subset T_\alpha(J_0),$$

and we immediately have that

$$I_\alpha^O := (\alpha, \alpha + 1) = T_\alpha(p_{i+1}, p_i) \subset T_\alpha^2(J_0).$$

If $T_\alpha(J_0)$ contains only one discontinuity point p of T_α , then $T_\alpha(J_0)$ is the disjoint union of two subintervals located in two adjacent cylinder sets:

$$T_\alpha(J_0) = J'_1 \cup J'_2.$$

Obviously,

$$|T_\alpha(J_0)| = |J'_1| + |J'_2|.$$

Now select the larger of these two intervals J'_1, J'_2 , and call this interval J_1 . Then

$$|J_1| \geq (1 + \frac{\varepsilon}{2})|J_0|.$$

In case $T_\alpha(J_0)$ does not contain any discontinuity point of T_α , we set $J_1 = T_\alpha(J_0)$. Induction yields that there exists an $\ell \in \mathbb{N}$ such that

$$|J_\ell| \geq \left(1 + \frac{\varepsilon}{2}\right)^\ell |J_0|,$$

whenever $T_\alpha(J_{\ell-1})$ includes no more than one discontinuity point of T_α . But then there must exist a $k \in \mathbb{N}$ such that $T_\alpha(J_k)$ contains two (or more) consecutive discontinuity points of T_α , and we find that $T_\alpha^2(J_k) = I_\alpha^O$. Applying Corollary 1, we conclude that there is no gap in I_α . □

Remark 5 As one of our referees remarked, the result from Theorem 3 is rather folklore. As to one of its first appearances we refer to Keith Wilkinson’s paper [13]; it might be interesting also to consult Gerhard Keller’s paper [6].

The next theorem, which is partly a corollary of the previous one, gives an even more explicit condition for gaplessness.

Theorem 4 *Let I_α consist of five cylinder sets or more. Then I_α has no gaps.*

Proof of Theorem 4, part I: Let I_α consist of five cylinder sets or more. Then $b(N, \alpha) > 3$, implying

$$\alpha < \frac{1}{2}\sqrt{\frac{4N}{3}} + 1 - \frac{1}{2} \text{ (cf. (11))}, \text{ in which case } |T'_\alpha(\alpha + 1)| > 3 - \frac{3\sqrt{12N + 9} - 9}{2N}.$$

The second inequality yields that for $N \in \mathbb{N}_{\geq 18}$ we have $|T'_\alpha(\alpha + 1)| > 2$ and, applying Theorem 3, I_α is gapless. Now suppose $N \in \{12, \dots, 17\}$. Then $b(N, \alpha) = 3$ involves arrangements with four cylinders. In each of these cases, the smallest α such that I_α has not yet (i.e. decreasing from α_{\max}) consisted of five cylinder sets is f_7 . In all six cases (two of which are illustrated in Fig. 4) we have $|T'_\alpha(f_7 + 1)| > 2$, yielding the gaplessness of I_α for arrangements with five or more cylinders in case $N \in \{12, \dots, 17\}$. This finishes the proof of Theorem 4 for $N \in \mathbb{N}_{\geq 12}$. For $N \in \{2, \dots, 11\}$ a similar approach does not work. We will use some ideas that we will

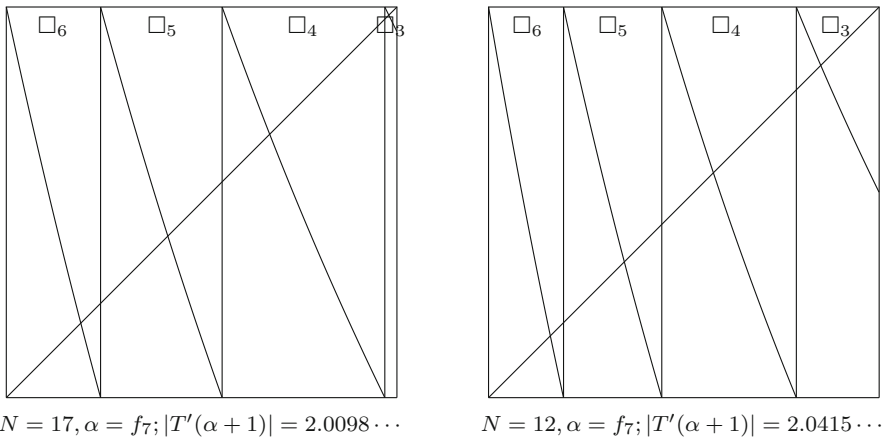

Fig. 4 Two arrangements illustrating the gaplessness of arrangements with five cylinders or more on account of Theorem 3

introduce and develop in the next sections and will finish the proof of Theorem 4 at the end of Sect. 5.

In the following we will go into conditions for gaplessness of arrangements consisting of less than five cylinders. We will start with two cylinders and will use the results for arrangements with three and four cylinders.

Remark 6 Since $b(N, \alpha)$ is a strictly decreasing function of α (cf. Lemma 4) and $b(N, \alpha_{\max}) = 1 + 1/(\sqrt{N} - 1)$, the condition $I_\alpha = \Delta_d \cup \Delta_{d-1}$ is never satisfied in case $N \in \{2, 3\}$.

3 Gaplessness if I_α consists of two cylinder sets

In general, if the branch number is not much larger than 1 (which is if α is not much smaller than α_{\max}), the overall expanding power of T_α , determined by T'_α (or $|T'_\alpha|$, which we will often use), is not enough to exclude the existence of gaps; we shall elaborate on this in a subsequent article. However, in the case of two cylinder sets $I_\alpha = \Delta_d \cup \Delta_{d-1}$, there is a very clear condition under which this power suffices:

Theorem 5 *Let $I_\alpha = \Delta_d \cup \Delta_{d-1}$. If $T_\alpha(\alpha) \geq f_{d-1}$ and $T_\alpha(\alpha + 1) \leq f_d$, then I_α is gapless.*

Although the statement of 5 is intuitively clear, for the proof of Theorem 5 we need several results and lemmas that we will prove first. Then, immediately following Remark 11, we will prove Theorem 5 itself.

Remark 7 In case $I_\alpha = \Delta_d \cup \Delta_{d-1}$ and either $T_\alpha(\alpha) < f_{d-1}$ or $T_\alpha(\alpha + 1) > f_d$, it is easy to see that $(T_\alpha(\alpha), T_\alpha^2(\alpha))$ or $(T_\alpha^2(\alpha + 1), T_\alpha(\alpha + 1))$ is a gap, respectively.

Since arrangements under the condition of Theorem 5 play an important role in this section, we introduce the following notations:

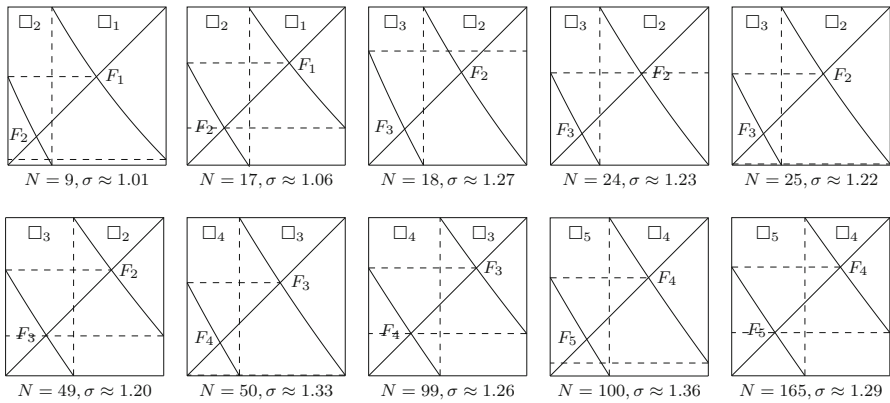

Fig. 5 Arrangements in $\mathcal{F}(d)$, $d \in \{2, 3, 4, 5\}$, where α is maximal

Definition 3 Let $N \in \mathbb{N}_{\geq 4}$ be fixed. For $d \in \mathbb{N}_{\geq 2}$, we define $\mathcal{F}(d)$ as the family of all arrangements $\Upsilon_{N,\alpha}$ such that $I_\alpha = \Delta_d \cup \Delta_{d-1}$, $T_\alpha(\alpha) \geq f_{d-1}$ and $T_\alpha(\alpha + 1) \leq f_d$. We will write $\mathcal{F}^*(d)$ in case α satisfies the equation $T_\alpha(\alpha) = f_{d-1}$, the root of which we will henceforth denote by $\alpha(N, d)$.

Remark 8 Note that for each $N \in \mathbb{N}_{\geq 4}$ and $d \in \mathbb{N}_{\geq 2}$ we have that $\alpha(N, d)$, if it exists, is the only value of α such that $\mathcal{F}^*(d)$ is not void.

If the expanding power of T_α is large enough to exclude the existence of gaps for the largest α for which an arrangement in $\mathcal{F}(d)$ exists, there will not be gaps in any arrangement in $\mathcal{F}(d)$. We will now first show how to find these largest α , which takes some effort. If we have finished that, we will go into the expanding power of $|T'_\alpha|$ in these arrangements with largest α .

For $4 \leq N \leq 8$, with $d = 2$, we have $T_{\alpha_{\max}}(\alpha_{\max}) > f_1$, while $T_{\alpha_{\max}}(\alpha_{\max} + 1) = \alpha_{\max} < f_2$. Hence we see $\Upsilon_{N,\alpha_{\max}} \in \mathcal{F}(2)$ and $\mathcal{F}(2) \neq \emptyset$. For $N \in \mathbb{N}_{\geq 9}$ we have $T_{\alpha_{\max}}(\alpha_{\max}) < f_1$. If $d = 2$ we can find α such that $\Upsilon_{N,\alpha} \in \mathcal{F}^*(2)$ for each $9 \leq N \leq 17$; see Fig. 5, where ten arrangements in various $\mathcal{F}(d)$ are drawn. Underneath each arrangement we have mentioned an approximation of $\sigma(\alpha) := |T'_\alpha(\alpha + 1)|$, which we will later return to. This σ is important, because it is the expanding power on the rightmost cylinder set that may be too weak to exclude gaps.

If $d = 2$ and $N \in \mathbb{N}_{\geq 18}$, the condition $T_\alpha(\alpha) = f_{d-1}$ yields $T_\alpha(\alpha + 1) > f_d$, and d has to increase by 1 so as to find an arrangement in $\mathcal{F}(3)$. If $d = 3$, for $18 \leq N \leq 24$ we find that the largest α is $f_{d-2} - 1$, in which case $T_\alpha(\alpha + 1) = \alpha < f_d$ and $T_\alpha(\alpha) > f_{d-1}$ (so in this case the arrangement with the largest α is in $\mathcal{F}(3)$ but not in $\mathcal{F}^*(3)$); for $25 \leq N \leq 49$, the largest α is such that $T_\alpha(\alpha) = f_2$. If $N \in \mathbb{N}_{\geq 50}$, the family $\mathcal{F}(3)$ is empty and d has to increase further; see Fig. 5 once more. In the proof of Lemma 8 this approach (of exhausting $\mathcal{F}(d)$ for successive values of N and going to $\mathcal{F}(d + 1)$ for larger values of N) will be formalised into a proof by induction. Due to (12) such an increase is always possible, no matter how large d and N become.

Note that this inductive approach works since for each d only finitely many N exist such that there are α with $\Upsilon_{N,\alpha} \in \mathcal{F}(d)$. To see why this claim holds, note that for

fixed N and d , the smallest α for which $d = d(\alpha) = d_{\max}$ is α_d , given by

$$\alpha_d = f_{d+1} = \frac{\sqrt{4N + (d + 1)^2} - (d + 1)}{2};$$

cf. (3). For this α it is not necessarily so that $I_{\alpha_d} = \Delta_d \cup \Delta_{d-1}$, i.e. that I_{α_d} consists of two cylinder sets (e.g. if $N = 2$ and $d = 5$, there are five cylinder sets). However, if $b(N, \alpha_d) \leq 2$, we know that I_{α_d} exists of two cylinder sets, the left one of which is full. According to Lemma 4, the branch number $b(N, \alpha_d)$ satisfies

$$b(N, \alpha_d) = \frac{N}{f_{d+1}(f_{d+1} + 1)} = \frac{4N}{4N + (d + 1)^2 - 2d\sqrt{4N + (d + 1)^2} + d^2 - 1}.$$

Keeping d fixed and letting $N \rightarrow \infty$, we find

$$\lim_{N \rightarrow \infty} b(N, \alpha_d) = 1.$$

In view of this and Lemma 3 (and the results mentioned directly thereafter), we choose N sufficiently large, such that for $\alpha \geq \alpha_d$ we have $b(N, \alpha) < 5/4$ and $f_{d-1} - f_d > 1/4$.

Now suppose that for such a sufficiently large value of N there exists an $\alpha \geq \alpha_d$, such that $\alpha \in \mathcal{F}(d)$. Then by Definition 2 of branch number and the assumption that $\alpha \in \mathcal{F}(d)$, we have that

$$b(N, \alpha) \geq 1 + f_{d-1} - f_d > \frac{5}{4},$$

which is impossible since for N sufficiently large, d fixed and $\alpha \geq \alpha_d$ we have

$$b(N, \alpha) \leq b(N, \alpha_d) < \frac{5}{4}.$$

It follows that for d fixed and N sufficiently large, $\mathcal{F}(d)$ is void.

We will prove (in Lemma 8) that if $N \in \mathbb{N}_{\geq 25}$ there exists a minimal $d \in \mathbb{N}_{\geq 3}$ such that the arrangement in $\mathcal{F}(d)$ with α maximal lies in $\mathcal{F}^*(d)$. Before we will prove this, we will explain the relation between d and N for arrangements in $\mathcal{F}^*(d)$.

In Fig. 5 we see that for $N \in \{49, 99, 165\}$ the arrangements in \mathcal{F}^* are very similar, and that the arrangement for $N = 100$ is more similar to these than the arrangement for $N = 50$. Moreover, the last three arrangements look hardly curved. This is easy to understand, considering the following equations, where $b(N, \alpha) = b$ is fixed:

$$|T'_\alpha(\alpha)| = \frac{b(\sqrt{4bN + b^2} + 2N + b)}{2N} \quad \text{and} \quad |T'_\alpha(\alpha)| - |T'_\alpha(\alpha + 1)| = \frac{b\sqrt{4bN + b^2}}{N}.$$

Since $(b\sqrt{4bN + b^2})/N$ is a decreasing function of N , approaching 0 from above as $N \rightarrow \infty$, the second equation implies that for a fixed branch number b the branches become less curved as N increases; i.e., the curves approach linearity as $N \rightarrow \infty$ and b

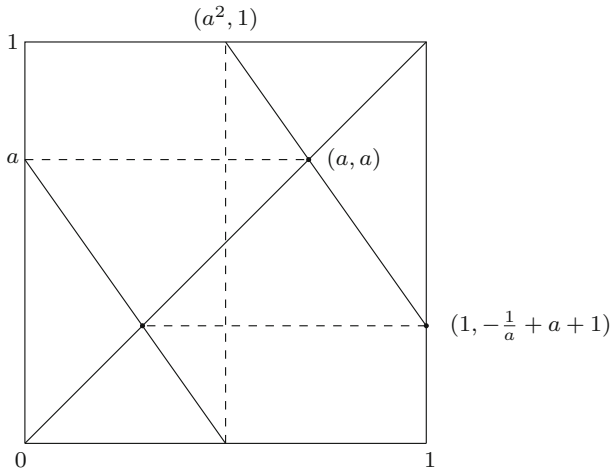

Fig. 6 The ‘limit graph’ of T_α , translated over $(-\alpha, -\alpha)$, under the conditions $I_\alpha = \Delta_d \cup \Delta_{d-1}$ and $N/\alpha - d = f_{d-1}$ for $N \rightarrow \infty$ (and $\alpha, d \rightarrow \infty$ accordingly)

is fixed. Although in $\mathcal{F}^*(d)$ the branch number is not so much fixed as bounded between 1 and 2, we have a similar decrease of curviness as N increases. The arrangements for $N \in \{49, 99, 165\}$ in Fig. 5 suggest that (assuming $T_\alpha(\alpha) = f_{d-1}$, i.e. $\alpha = \alpha(N, d)$) if $N \rightarrow \infty$ (and $d \rightarrow \infty$ and $\alpha \rightarrow \infty$ accordingly), the difference $f_d - T_\alpha(\alpha + 1)$ tends to 0, yielding a ‘limit graph’ of T_α that consists of two parallel line segments (the straightened branch curves of T_α); see Fig. 6, obtained by translating the graph over $(-\alpha, -\alpha)$. In this situation we have both $a := T_\alpha(\alpha) \pmod{\alpha} = f_{d-1} \pmod{\alpha}$ and $T_\alpha(\alpha + 1) = f_d$ (also $\pmod{\alpha}$ in Fig. 6). Because in the limit both parts of the graph are linear with the same slope, we also have that $(0, a + 1)$ lies on the prolonged right line segment, from which we derive that the line segments have slope $-1/a$. The line with equation $y = -\frac{x}{a} + a + 1$ intersects the line $y = 1$ at $(a^2, 1)$ (so the dividing line is $x = a^2$) and intersects the line $x = 1$ in $(1, -\frac{1}{a} + a + 1)$, yielding the point $(-\frac{1}{a} + a + 1, -\frac{1}{a} + a + 1)$ on the line through $(0, a)$ with equation $y = -\frac{x}{a} + a$ (since $T_\alpha(\alpha + 1) = f_d$). From this we derive $2a^2 = 1$, so $a = \sqrt{1/2}$.

From Fig. 6 we almost immediately find that the branch number for the limit case is $\sqrt{2}$ and that the dividing line is at $1/2$. We use this *heuristic* to find a formula describing the relation between N and d for arrangements in $\mathcal{F}^*(d)$ very precisely. Note that for arrangements similar to the limit graph we have

$$1 + f_{d-1} - f_d = \frac{\sqrt{4N + (d - 1)^2} - \sqrt{4N + d^2} + 1}{2} + 1 \approx b(N, \alpha) \approx \sqrt{2},$$

from which we derive

$$N \approx (4 + 3\sqrt{2})(d^2 - d) + 2 \quad \text{or} \quad d \approx \frac{1}{2} \left(1 + \sqrt{(6\sqrt{2} - 8)(N - 2) + 1} \right). \quad (13)$$

If, for d fixed, we determine arrangements in $\mathcal{F}^*(d)$ such that the difference $f_d - T_\alpha(\alpha + 1)$ is positive and as small as possible according to our heuristic, the best function seems to be $N = (4 + 3\sqrt{2})(d^2 - d)$, yielding the right N (after rounding off to the nearest integer) for $d \in \{3, \dots, 500\} \setminus \{9, 50, 52, 68, 69, 80, 97, 129, 167, 185, 210, 231, 289, 330, 416, 440, 444, 479, 485\}$, in all of which cases the rounding off should have been up instead of down. For $d = 2$ we find $N = \lceil 2(4 + 3\sqrt{2}) \rceil = 17$, for $d = 3$ we find $N = \lfloor 6(4 + 3\sqrt{2}) \rfloor = 49$, for $d = 4$ we find $N = \lceil 12(4 + 3\sqrt{2}) \rceil = 99$ and for $d = 5$ we find $N = \lceil 20(4 + 3\sqrt{2}) \rceil = 165$; see Fig. 5 once more.

Although we do not know generally if rounding off to the nearest integer yields the right N , with (13) we can find a very good overall indication of the relation between d and N for arrangements in $\mathcal{F}^*(d)$ by looking at the difference between the image of $\alpha(N, d) + 1$ and f_d ; see Definition 3. With some straightforward calculations we find that

$$\alpha(N, d) = \frac{N \left(\sqrt{4N + (d - 1)^2} - (d + 1) \right)}{2(N - d)}. \tag{14}$$

Applying (14), we write $f_d(N) - (N/(\alpha(N, d) + 1) - (d - 1))$ as

$$j_d(N) := \frac{(N^2 + dN + d)\sqrt{4N + d^2} - N^2\sqrt{4N + (d - 1)^2} - (N^2 - d(d - 4)N - d(d - 2))}{2(N^2 + dN + d)}$$

and, more generally, define

$$j_d(x) := \frac{(x^2 + dx + d)\sqrt{4x + d^2} - x^2\sqrt{4x + (d - 1)^2} - (x^2 - d(d - 4)x - d(d - 2))}{2(x^2 + dx + d)} \tag{15}$$

for $x \in [25, \infty)$.

We note that $I_\alpha = \Delta_d \cup \Delta_{d-1}$ is equivalent to $N/(\alpha + 1) - (d - 1) \geq \alpha$. In case $\alpha = \alpha(N, d)$, we have

$$\frac{N}{\alpha(N, d) + 1} - (d - 1) = \frac{N^2\sqrt{4N + (d - 1)^2} - ((d - 1)N^2 + 2d(d - 2)N + 2d(d - 1))}{2(N^2 + dN + d)}. \tag{16}$$

Applying (16), for the difference $h_d(N) := N/(\alpha(N, d) + 1) - (d - 1) - \alpha(N, d)$ we write

$$h_d(N) := \frac{2N^3 + 4dN^2 + (2d^3 - 5d^2 + 3d)N + 2d^2(d - 1) - dN(2N + 1)\sqrt{4N + (d - 1)^2}}{2(N - d)(N^2 + dN + d)}, \tag{17}$$

and, more generally, define

$$h_d(x) := \frac{2x^3 + 4dx^2 + (2d^3 - 5d^2 + 3d)x + 2d^2(d - 1) - dx(2x + 1)\sqrt{4x + (d - 1)^2}}{2(x - d)(x^2 + dx + d)}, \tag{18}$$

for $x \in [25, \infty)$.

Now we can prove the lemma that is illustrated by the arrangements for $N \in \{17, 49, 99, 165\}$ in Fig. 5. In order to do so, we define for fixed $d \in \mathbb{N}_{\geq 2}$

$$S(d) := \{N \in \mathbb{N}_{\geq 4} : I_\alpha = \Delta_d \cup \Delta_{d-1}, T_\alpha(\alpha) = f_{d-1}(N) \text{ and } T_\alpha(\alpha + 1) \leq f_d(N)\}$$

and

$$M_d := \max S(d).$$

Lemma 6 *Let $d \in \mathbb{N}_{\geq 2}$. Then $M_d \in \{\lfloor (4 + 3\sqrt{2})(d^2 - d) \rfloor, \lceil (4 + 3\sqrt{2})(d^2 - d) \rceil\}$.*

Proof of Lemma 6 First we note that for $d = 2$, we have that $\lceil (4 + 3\sqrt{2})(d^2 - d) \rceil$ equals 17, which corresponds with what we had already calculated and drawn in Fig. 5. Now let $d \in \mathbb{N}_{\geq 3}$. First we have to show that $h_d(M_d) > 0$ for $M_d \in \{\lfloor (4 + 3\sqrt{2})(d^2 - d) \rfloor, \lceil (4 + 3\sqrt{2})(d^2 - d) \rceil\}$, for this assures us that $I_\alpha = \Delta_d \cup \Delta_{d-1}$. We will leave this to the reader; it is merely very cumbersome to show, while technically straightforward.⁵

The only thing left to do is showing that

$$\begin{cases} j_d((4 + 3\sqrt{2})(d^2 - d)) > 0; \\ j_d((4 + 3\sqrt{2})(d^2 - d) + 1) < 0, \end{cases} \tag{19}$$

since the first equation implies that $j_d(\lfloor (4 + 3\sqrt{2})(d^2 - d) \rfloor) > 0$, while the second implies that $j_d(\lceil (4 + 3\sqrt{2})(d^2 - d) \rceil + 1) < 0$. The work to be done is as cumbersome and straightforward as the previous work to be done for this proof and is left to the reader as well. □

Before we will show that for $N \in \mathbb{N}_{\geq 25}$ there are a $d \in \mathbb{N}_{\geq 3}$ and an α such that $\gamma_{N,\alpha} \in \mathcal{F}^*(d)$, we will prove the following lemma:

Lemma 7 *Let $d \in \mathbb{N}_{\geq 3}$. Let $N \in \mathbb{N}_{\geq 25}$ be such that $I_{\alpha(M_d,d)} = \Delta_d \cup \Delta_{d-1}$ and $T_{\alpha(M_d,d)}(\alpha(M_d,d)) = f_{d-1}$ for $M_d \in \{N, N + 1\}$. Then*

$$T_{\alpha(N+1,d)}(\alpha(N + 1, d) + 1) - \alpha(N + 1, d) > T_{\alpha(N,d)}(\alpha(N, d) + 1) - \alpha(N, d),$$

i.e. $h_d(N + 1) > h_d(N)$.

Proof of Lemma 7 We want to show that $h_d(N)$ from (17) is an increasing sequence, and do so by calculating the derivative of with $x \in [25, \infty)$, and then showing that $h'_d(x) > 0$ on $[25, \infty)$. Although a little bit intricate, the work is straightforward and is left to the reader. □

Now we can prove the following lemma:

⁵ We have throughout this paper frequently used (Wolfram) *Mathematica* for making intricate calculations, all of which are nonetheless algebraically basic. In relevant cases we think it will be evident if we did.

Lemma 8 Let $N \in \{9, \dots, 17, 25, 26, \dots\}$. Then there are $d \in \mathbb{N}_{\geq 2}$ and $\alpha \in (0, \sqrt{N} - 1)$ such that $I_\alpha = \Delta_d \cup \Delta_{d-1}$, $T_\alpha(\alpha) = f_{d-1}$ and $T_\alpha(\alpha + 1) \leq f_d$ (i.e. $\alpha = \alpha(N, d)$).

Proof of Lemma 8 We will use induction on d . For $N \in \{9, \dots, 17, 25, 26, \dots, 99\}$ and $d \in \{2, 3, 4\}$ we refer to Fig. 5 and leave the calculations to the reader. Specifically, we have for $50 \leq N \leq 99$ that $\Upsilon_{N,\alpha(N,4)} \in \mathcal{F}^*(4)$. It is easily seen that $\Upsilon_{99,\alpha(99,5)} \in \mathcal{F}^*(5)$ as well. Due to Lemma 6, there is an $N_5 > 99$ such that $\Upsilon_{N_5,\alpha(N_5,5)} \in \mathcal{F}^*(5)$. Applying Lemma 7, we see that for all $N \in \{99, \dots, N_5\}$ we have $\Upsilon_{N,\alpha(N,5)} \in \mathcal{F}^*(5)$. For the induction step, let $d \in \mathbb{N}_{\geq 5}$ be such that there is an α for which $\Upsilon_{N_d,\alpha} \in \mathcal{F}^*(d)$, where N_d is the largest such N possible, cf. Lemma 6. If we can show that for this N_d there is an α' such that $\Upsilon_{N_d,\alpha'} \in \mathcal{F}^*(d + 1)$, we are finished. This can be done by showing that

$$h_{d+1}((4 + 3\sqrt{2})(d^2 - d) - 1) > 0, \tag{20}$$

for this implies $h_{d+1}(N_d) > 0$, in which case α' is such that $\frac{N_d}{\alpha'} - (d + 1) = f_d$, i.e. $\alpha' = \alpha(N, d + 1)$. Although intricate, the calculations are straightforward and are left to the reader. □

Remark 9 Although Lemma 8 is about N in the first place, our approach is actually based on increasing d and then determining all N such that arrangements $\Upsilon_{N,\alpha} \in \mathcal{F}^*(d)$ exist. The proof of Lemma 8 yields the arrangements with the *smallest* d (and therefore the largest α) for which $\Upsilon_{N,\alpha} \in \mathcal{F}^*(d)$, as illustrated by the last five arrangements of Fig. 5.

Example 1 For $d = 4$ we have $M_d - 1 = \lfloor (4 + 3\sqrt{2})(d^2 - d) \rfloor = 98$. Then $\Upsilon_{M_d-1,\alpha(M_d-1,4)} \in \mathcal{F}^*(4)$ and $\Upsilon_{M_d,\alpha(M_d,4)} \in \mathcal{F}^*(4)$, while $\Upsilon_{M_d+1,\alpha(M_d+1,5)} \in \mathcal{F}^*(5)$; see Fig. 5. It follows immediately from our construction of $\alpha(M_d + 1, 5)$ that this is the largest α such that $\Upsilon_{M_d+1,\alpha} \in \mathcal{F}^*(5)$.

With manual calculations we can quickly calculate the expanding power of T_α in $\alpha + 1$ for arrangements in \mathcal{F} and \mathcal{F}^* and N not too large, say $N \in \mathbb{N}_{\leq 49}$, where the smallest values are found where α is as large as possible. The next proposition gives a lower bound for $|T'_\alpha(\alpha + 1)|$ for such arrangements for most N .

Proposition 1 Let $N \in \{18\} \cup \{50, 51, \dots\} \setminus \{95, \dots, 99\}$ and $\alpha \in (0, \sqrt{N} - 1]$ such that $I_\alpha = \Delta_d \cup \Delta_{d-1}$ for some $d \in \mathbb{N}$, $d \in \mathbb{N}_{\geq 2}$. Furthermore, suppose that $T_\alpha(\alpha) \geq f_{d-1}$ and $T_\alpha(\alpha + 1) \leq f_d$. Then $|T'_\alpha(\alpha + 1)| > \sqrt[3]{2} = 1.259921 \dots$

Proof of Proposition 1 Considering Lemma 8, we can confine ourselves to arrangements in \mathcal{F}^* with α as large as possible. For $\alpha = \alpha(N, d)$ (cf. (14)) we can write $|T'_\alpha(\alpha + 1)| = N/(\alpha + 1)^2$ as

$$k_d(N) = \frac{2N^4 + (d - 1)^2N^3 + 2d(d - 1)N^2 + 2d^2N + ((d - 1)N^3 + 2dN^2)\sqrt{4N + (d - 1)^2}}{2(N^4 + 2dN^3 + d(d + 2)N^2 + 2d^2N + d^2)}. \tag{21}$$

It is not hard to find that, for d fixed, k_d is a decreasing sequence, with $\lim_{N \rightarrow \infty} k_d(N) = 1$. However, from (13) it follows that if $N \rightarrow \infty$ we have that also $d \rightarrow \infty$ in a precise manner. Due to the previous lemmas, for each d we can confine ourselves to considering only $N/(\alpha + 1)^2$ for the largest N and α such that $\mathcal{Y}_{N,\alpha} \in \mathcal{F}^*(d)$. Applying Lemma 6, an easy way to check if indeed $|T'_{\alpha(N,d)}(\alpha(N, d) + 1)| > \sqrt[3]{2}$ is considering $k_d(x)$, with $x \in [100, \infty)$, and then calculating $k_d((4 + 3\sqrt{2})(d^2 - d) + 1)$ for $d \in \mathbb{N}_{\geq 5}$, which is amply larger than $\sqrt[3]{2} = 1.2599\dots$. For the remaining cases $d = 3$ and $N = 18$ and for $d = 4$ and $N \in \{50, 51, \dots, 94\}$ it is easily checked manually that indeed $|T'_{\alpha(N,d)}(\alpha(N, d) + 1)| > \sqrt[3]{2}$. \square

Remark 10 Considering our previous remarks concerning arrangements in \mathcal{F}^* , it may be clear that $\lim_{N \rightarrow \infty} N/(\alpha(N, d) + 1)^2 = \sqrt{2}$.

Remark 11 The value $\sqrt[3]{2}$ in the proof of Proposition 1 relates to the proof of Theorem 5 and also to the proofs of Proposition 9 and Theorem 3, where the numbers $\sqrt{2}$ and 2 have a similar importance. Considering the proof of Proposition 1, we could actually replace $\sqrt[3]{2}$ by the smallest possible value, given by

$$\frac{94}{(\alpha(94) + 1)^2} = \frac{20480015 + 320305\sqrt{385}}{21233664} = 1.2604\dots$$

Finally we are ready to prove Theorem 5, stating that $I_\alpha = \Delta_d \cup \Delta_{d-1}$, with $d := d(\alpha)$, is gapless if $T_\alpha(\alpha) \geq f_{d-1}$ and $T_\alpha(\alpha + 1) \leq f_d$. Considering Remark 11 the value $\sqrt[3]{2}$ in Proposition 1 can be replaced by 1.26, the third power of which is 2.000376. We will use this to stress that the gaplessness of Theorem 5 is actually relatively ample and does not require infinitesimal estimations.

Proof of Theorem 5 First we note that the conditions imply $N \in \mathbb{N}_{\geq 4}$. Now let $\mathcal{Y}_{N,\alpha} \in \mathcal{F}(d)$ and let $K \subset I_\alpha$ be any open interval. Since K expands under T_α , there is an $n \in \mathbb{N} \cup \{0\}$ such that $T_\alpha^n(K)$ contains for the first time a fixed point or the discontinuity point p_d , in the former case of which we are finished. So we assume that $T_\alpha^n(K) \cap \Delta_d = (b, p_d] =: L$, with $f_d < b < p_d$. Note that $T_\alpha(L) = [\alpha, T_\alpha(b)) \subset [\alpha, f_d)$. For $T_\alpha^2(L) = (T_\alpha^2(b), T_\alpha(\alpha))$, we similarly may assume that $f_{d-1} < T_\alpha^2(b) < \alpha + 1$ (since otherwise $f_{d-1} \in T_\alpha^2(L)$, and again we are done).

Now suppose that $T_\alpha^3(L)$ contains p_d , excluding $f_d \in T_\alpha^3(L)$. Then $T_\alpha^3(L) = L_1 \cup M_1$, with $L_1 = [T_\alpha^2(\alpha), p_d]$ and $M_1 = (p_d, T_\alpha^3(b))$. First we confine ourselves to $N \in \{18\} \cup \{50, \dots\} \setminus \{95, \dots, 99\}$. Since then $|T_\alpha^3(L)| > 2.000376|L|$ (cf. Remark 11), we have certainly $|L_1| > 1.001|L|$ or $|M_1| > 1.001|L|$. If we consider the images of L_1 and M_1 under T_α, T_α^2 and T_α^3 similarly as we did with the images of L , we find that due to expansiveness (see the proof of Theorem 3) there *must* be an m such that $f_d \in T_\alpha^{3m}(L_1)$ or $f_{d-1} \in T_\alpha^{3m}(M_1)$ and we are finished. If $T_\alpha^3(L)$ does *not* contain p_d , the expansion of L will only go on longer, yielding even larger L'_1 and M'_1 and the reasoning would only be stronger that no gaps can exist.

For $N \in \{4, \dots, 17, 19, 20, \dots, 49, 95, 96, \dots, 99\}$ a similar approach can be taken, but there is no useful general lower bound for $|T'_\alpha(x)|$ on I_α . For these cases,

however, the moderate expanding power in Δ_{d-1} is easily made up for by a relatively strong expanding power in Δ_d , and the gaplessness is easily, although tediously, checked by hand (cf. Examples 2 and 3 below). This finishes the proof of Theorem 5. \square

Example 2 In case $N = 7$, there exist $\alpha \in (0, \sqrt{7} - 1]$ for which $I_\alpha = \Delta_2 \cup \Delta_1$. The largest α for which $\Upsilon_{7,\alpha} \in \mathcal{F}(2)$ is $\alpha_{\max} = \sqrt{7} - 1$, in which case $|T'_\alpha(\alpha + 1)| = 1$. However, $|T'_\alpha(f_2)| = 2.0938 \dots > 2$, and the approach taken above even works due to the expanding power of T_α on $[\alpha, f_2)$ alone.

Example 3 In case $N = 99$, we have $I_\alpha = \Delta_4 \cup \Delta_3$, and $\Upsilon_{99,\alpha} \in \mathcal{F}^*$ for $\alpha = 99(\sqrt{405} - 5)/190 = 7.8807 \dots$. Then $|T'_\alpha(\alpha + 1)| = 1.2552 \dots$, $|T'_\alpha(f_3)| = 1.3503 \dots$ and $|T'_\alpha(f_4)| = 1.4908 \dots$. So for an interval (p_4, x) , with $x \in (p_d, f_3)$, assuming that $f_4 \notin T_\alpha^3(p_4, x)$, we have $|T_\alpha^3(p_4, x)| > 1.3503 \dots \times 1.2552 \dots \times 1.4908 \dots \times |(p_4, x)| \gg 2|(p_4, x)|$, implying enough expanding power for T_α^3 to exclude the existence of gaps.

Remark 12 We can also prove that $|T'_\alpha(x)| > \sqrt{2}$ on Δ_d for all arrangements under the assumptions of Theorem 5, but we cannot do without knowledge about the slope on Δ_{d-1} .

Next we will make preparations for formulating a sufficient condition for gaplessness in case I_α consists of three cylinder sets. Proving it involves more subtleties on the one hand, but will have a lot of similarities with the two-cylinder set case on the other hand. Once we have finished that, not much work remains to be done for gaplessness in case I_α consists of four or five cylinder sets.

4 A sufficient condition for gaplessness if I_α consists of three or four cylinder sets

If $I_\alpha = \Delta_d \cup \dots \cup \Delta_{d-m}$, with $m \in \{2, 3\}$, there is a sufficient condition for gaplessness that resembles the condition for gaplessness in case I_α consists of two cylinder sets a lot:

Theorem 6 *Let $I_\alpha = \Delta_d \cup \dots \cup \Delta_{d-m}$, with $m \in \{2, 3\}$. Then I_α is gapless if*

$$T_\alpha(\alpha) \geq f_{d-1} \quad \text{or} \quad T_\alpha(\alpha + 1) \leq f_{d-m+1}.$$

We will prove this theorem in parts. In Sect. 4.1 we will prove Theorem 6 for $m = 2$; in Sect. 4.2 we will extend the result of Sect. 4.1 to $m = 3$; considering Theorem 4, extension to larger m is not useful.

Remark 13 The difference between the ‘and’ of Theorem 5 and the ‘or’ of Theorem 6 has to do with the existence, in the latter case, of at least one full cylinder set.

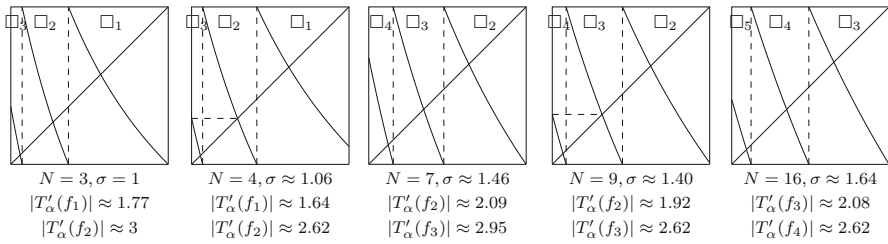

Fig. 7 Arrangements with largest α such that there is a d with $I_\alpha = \Delta_d \cup \Delta_{d-1} \cup \Delta_{d-2}$ under the condition $T_\alpha(\alpha) \geq f_{d-1}$ and $T_\alpha(\alpha + 1) \leq f_{d-1}$

4.1 Gaplessness if I_α consists of three cylinder sets

Since we have $m = 2$, the condition $T_\alpha(\alpha) \geq f_{d-1}$ can be split in

$$\begin{cases} 1. & T_\alpha(\alpha + 1) \leq f_{d-1} \leq T_\alpha(\alpha); \\ 2. & f_{d-1} \leq T_\alpha(\alpha) \leq T_\alpha(\alpha + 1); \\ 3. & f_{d-1} \leq T_\alpha(\alpha + 1) \leq T_\alpha(\alpha); \end{cases} \tag{22}$$

of course the condition $T_\alpha(\alpha + 1) \leq f_{d-1}$ can be split in a similar way. We will prove Theorem 6 by proving gaplessness according to this distinction in three cases, associated with Lemmas 9, 10 and 11 respectively. The first of these is not very hard to prove:

Lemma 9 *Let $I_\alpha = \Delta_d \cup \Delta_{d-1} \cup \Delta_{d-2}$. If $T_\alpha(\alpha) \geq f_{d-1}$ and $T_\alpha(\alpha + 1) \leq f_{d-1}$, then I_α is gapless.*

Proof of Lemma 9 The assumptions imply that $b(N, \alpha) > 2$, yielding $\sigma(\alpha) = |T'_\alpha(\alpha + 1)| > \sqrt{2}$ for $N \in \mathbb{N}_{\geq 17}$. If $N \in \mathbb{N}_{\geq 17}$, we let $K \subset I_\alpha$ be any open interval. Since K expands under T_α , there is an $n \in \mathbb{N} \cup \{0\}$ such that $T_\alpha^n(K)$ contains a fixed point or a discontinuity point p_{d-i} (with $i \in \{0, 1\}$), in the former case of which we are finished. So we assume that $T_\alpha^n(K) \supset L$, where $L = (b, p_{d-i}]$, with $f_{d-i} < b < p_{d-i}$, with $i \in \{0, 1\}$. If $T_\alpha(L)$ contains a fixed point, we are finished. If $T_\alpha(L)$ does not contain a fixed point, then it cannot contain a discontinuity point, and we have that $|T_\alpha^2(L)| > 2|L|$, implying enough expanding power of T_α to ensure gaplessness of at least one cylinder set (which might be non-full). Since both $T_\alpha(\alpha) \geq f_{d-1}$ and $T_\alpha(\alpha + 1) \leq f_{d-1}$, it follows that I_α is gapless. For $2 \leq N \leq 16$ the slopes on I_α may differ considerably: for some N , such as $N = 7$ and $N = 16$ we also have $\sigma > \sqrt{2}$, but if this is not the case, the steepness left of f_{d-2} is amply larger than $\sqrt{2}$; see Fig. 7 for some examples where α is as large as possible. This finishes the proof of Lemma 9 [cf. case 1 in (22)]. \square

If $I_\alpha = \Delta_d \cup \Delta_{d-1} \cup \Delta_{d-2}$ under the condition $T_\alpha(\alpha) \geq f_{d-1}$ and $T_\alpha(\alpha + 1) > f_{d-1}$ or under the condition $T_\alpha(\alpha) < f_{d-1}$ and $T_\alpha(\alpha + 1) \leq f_{d-1}$, I_α is gapless as well, but this is much harder to prove. The following definition will be convenient:

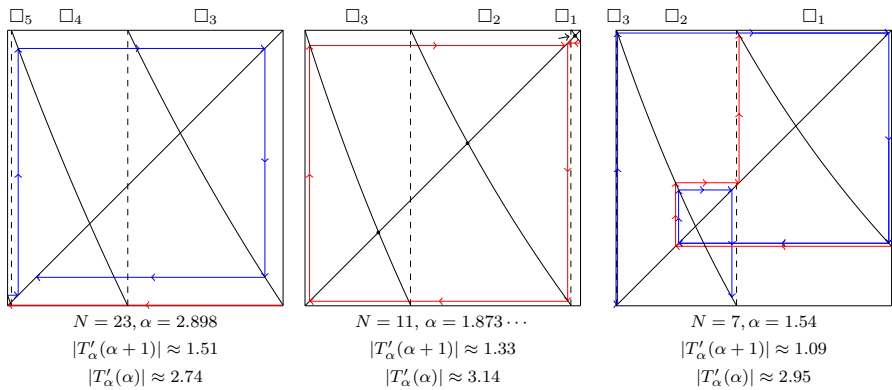

Fig. 8 Arrangements with one very small cylinder

Definition 4 Let $I_\alpha = \Delta_d \cup \dots \cup \Delta_{d-m}$, and $1 \leq m \leq d - 1$. If $T_\alpha(\alpha) \leq f_{d-1}$ or $T_\alpha(\alpha + 1) \geq f_{d-m+1}$, the cylinder set Δ_d respectively Δ_{d-m} is called *small*.

Taking a similar approach as in the proof of Theorem 5, one can show that the map T_α has enough expansive power to ensure that for any open interval $K \subset I_\alpha$ there exists a non-negative integer n such that $T_\alpha^n(K)$ contains a fixed point. If this fixed point is in a non-small or even full cylinder set, we are done (as in the proofs of Theorem 5 and Lemma 9). However, if this fixed point is from the *small* cylinder set, then it only follows that every point of the small cylinder set is in the orbit under T_α of some point in K . Note this implies that the *small* cylinder set is *gapless*. So we may assume that the small cylinder set is gapless. Let us assume that the left cylinder set is small. We define $L := T_\alpha(\Delta_d) \setminus \Delta_d$. Since Δ_d is gapless, we have $L = (p_d, T_\alpha(\alpha)) \subset (p_d, f_{d-1})$, so $T_\alpha(L) = [T_\alpha^2(\alpha), \alpha + 1)$. If $T_\alpha^2(\alpha) \leq f_{d-2}$, we are finished, so we assume that $T_\alpha^2(\alpha) > f_{d-2}$. We then have $T_\alpha^2(L) = (T_\alpha(\alpha + 1), T_\alpha^3(\alpha))$. If $T_\alpha^3(\alpha) \geq f_{d-1}$ we are finished, since then $f_{d-1} \in T_\alpha^2(L)$.

The question arises whether it is possible to keep avoiding fixed points if we go on with letting T_α work on L and its images (or similarly, if the right cylinder set is small, some interval $R := T_\alpha(\Delta_1) \setminus \Delta_1$). We will argue that this is not possible in the two most plausible cases for gaps to exist, involving the least expansion.

The first case is illustrated with two arrangements in Fig. 8, one where $N = 23$ and one where $N = 11$. In both arrangements one outer cylinder is very small while the other one is full or almost full. In the arrangement where $N = 23$, we see that L is a very narrow strip between p_5 and $T_\alpha(\alpha)$, $T_\alpha^2(L)$ is not so narrow anymore, and $T_\alpha^3(L)$ is definitely wide enough to make clear that avoiding fixed points f_4 and f_3 is not possible. The middle arrangement, where $N = 11$, is an example of the case where Δ_{d-2} is small and Δ_d is actually full. Here we have that $R := T_\alpha(\Delta_1) \setminus \Delta_1$ is a very narrow strip between $T_\alpha(\alpha + 1)$ and p_2 and that $T_\alpha^2(R)$ is only slightly larger than $T_\alpha(\Delta_1)$, whence eventually there will be an $n \in \mathbb{N}$ such that $f_3 \in T_\alpha^n(R)$ or $f_2 \in T_\alpha^n(R)$.

The rightmost arrangement in Fig. 8 is an illustration of the second plausible case for the existence of gaps: here Δ_3 is small, while Δ_1 is incomplete but *not* small. This

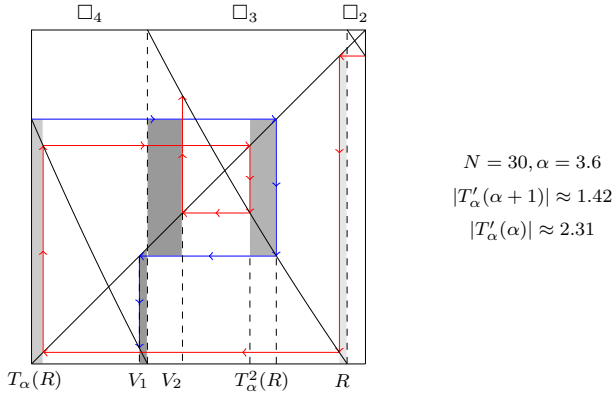

Fig. 9 Arrangement illustrating Lemma 10

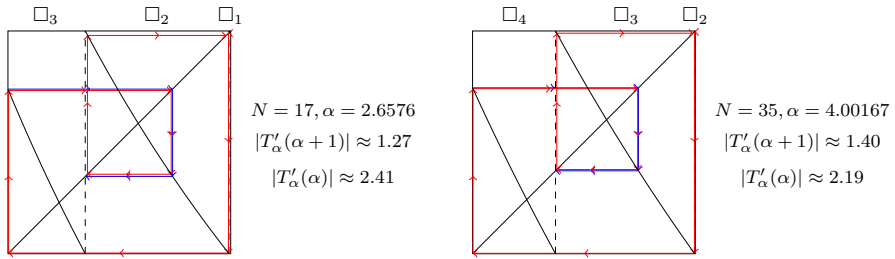

Fig. 10 Two arrangements in which almost $T_\alpha^2(\alpha) < p_d < T_\alpha^4(\alpha + 1)$ (in fact, in both cases $p_d = T_\alpha^2(\alpha)$)

arrangement illustrates the role p_d might play in avoiding fixed points: in this case, taking $L := T_\alpha(\Delta_3) \setminus \Delta_3$, we have $T_\alpha^3(L) = M_1 \cup M_2$, with $M_1 = [T_\alpha^4(\alpha), p_2]$ and $M_2 = (p_2, T_\alpha^2(\alpha + 1)]$. Since $T_\alpha^3(L)$ contains a discontinuity point, the expansion under T_α is interrupted. If $T_\alpha(M_1)$ would be a subset of $T_\alpha(\Delta_3)$ and $T_\alpha(M_2)$ would be a subset of $T_\alpha(L)$, the expansion would be finished and we would have three gaps: $(T_\alpha(\alpha), T_\alpha(\alpha + 1))$, $(T_\alpha^3(\alpha), T_\alpha^4(\alpha))$ and $(T_\alpha^2(\alpha + 1), T_\alpha^2(\alpha))$ —but this is not the case, as we will shortly prove.

Of course arrangements exist such that one of the outer cylinders is small, fixed points are avoided (in the sense we used above) for a long time and it takes more of T_α working on L or R before one of the discontinuity points is captured. But in these cases the interruption of the expansion is even weaker than in the cases above. We will first show that arrangements such as the rightmost one of Fig. 8 exclude the existence of gaps (cf. Lemma 10) and will then consider cases such as the first two arrangements of Fig. 8 (cf. Lemma 11).

Lemma 10 *Let $I_\alpha = \Delta_d \cup \Delta_{d-1} \cup \Delta_{d-2}$. Then I_α is gapless if*

$$f_{d-1} \leq T_\alpha(\alpha) \leq T_\alpha(\alpha + 1) \quad \text{or} \quad T_\alpha(\alpha) \leq T_\alpha(\alpha + 1) \leq f_{d-1}.$$

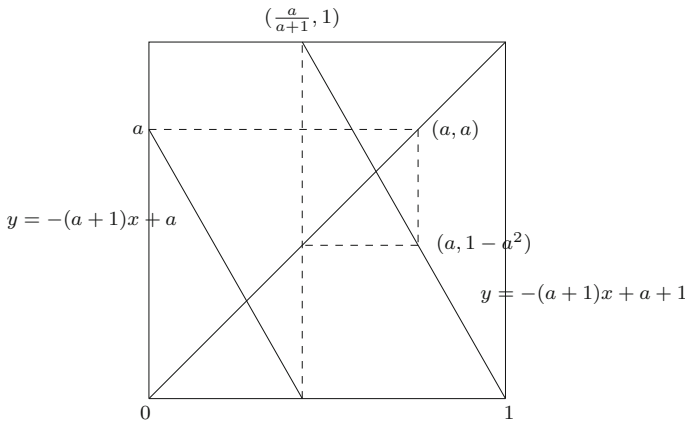

Fig. 11 The ‘limit graph’ of T_α , translated over $(-\alpha, -\alpha)$, under the conditions $I_\alpha = \Delta_d \cup \Delta_{d-1}$ and $N/(N/\alpha - d) - (d - 1) = p_d$ for $N \rightarrow \infty$ (and $\alpha, d \rightarrow \infty$ accordingly). This ‘arrangement’ can be seen as one with three cylinders, where $\Delta_{d-2} \pmod{\alpha}$, the one on the right, is infinitely small; see also the arrangements in Fig. 10

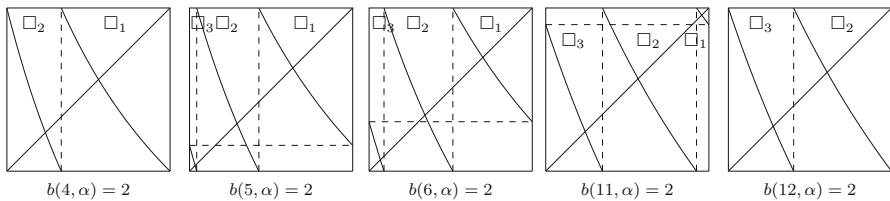

Fig. 12 Arrangements of $\Upsilon_{N,\alpha}$ with $b = 2$; in each case $\alpha = \frac{\sqrt{2N+1}-1}{2}$

Proof of Lemma 10 We will confine ourselves to the first case of this lemma, that is if $f_{d-1} \leq T_\alpha(\alpha) \leq T_\alpha(\alpha + 1)$, since the second one is proved similarly (in fact, this case is slightly harder due to the smaller size of the absolute value of the derivatives). Regarding our observations above, we may assume that the small cylinder set (which in this case is Δ_{d-2}) is gapless (cf. the remarks after Definition 4). We will show that this implies the gaplessness of the other cylinder sets as well. We define $R := T_\alpha(\Delta_{d-2}) \setminus \Delta_{d-2}$ and try to determine α such that $p_d \in T_\alpha^3(R)$ (see the remark immediately preceding this lemma). Necessary conditions for this are $T_\alpha^2(\alpha) < p_d < T_\alpha^4(\alpha + 1)$ (assuming that $f_d \notin T_\alpha(R)$ and $f_{d-1} \notin T_\alpha^2(R)$, since in either case we would be done). If these conditions are satisfied, we write $T_\alpha^3(R) = V_1 \cup V_2$, with $V_1 = [T_\alpha^2(\alpha), p_d]$ and $V_2 = (p_d, T_\alpha^4(\alpha + 1)]$. We will show that we cannot have both $T_\alpha(V_1) \subset T_\alpha(R)$ and $T_\alpha(V_2) \subset T_\alpha(\Delta_{d-2})$, which is necessary for limiting the expansion of R under T_α and so not eventually capturing f_d and f_{d-1} ; see Fig. 9.

We take an approach that is similar to the proof of Theorem 5, for which several lemmas and a proposition were used, partially concerning a relation between N and d in the arrangements involved, partially concerning the slope in $\alpha + 1$. In this proof we will not explicitly formulate similar statements as lemmas or propositions, nor do

we prove them, since they require similar basic but very intricate calculations that we prefer to omit.

In order to find the relationship between N and d for arrangements with the conditions $T_\alpha^2(\alpha) < p_d$ and $T_\alpha^4(\alpha + 1) > p_d$ mentioned above, we refer to some more relevant arrangements, as shown in Fig. 10. In both cases in Fig. 10, α is such that $T_\alpha^2(\alpha) = p_d$, which is a value of α that is only a little larger than the values for which $T_\alpha^2(\alpha) < p_d$ and $T_\alpha^4(\alpha + 1) > p_d$. A ‘limit arrangement’ (where the third, rightmost cylinder is infinitely small), similar to the ‘limit arrangement’ used in the proof of Theorem 5, is shown in Fig. 11. The assumptions yield $a^3 + a^2 - 1 = 0$, with real root $a = 0.75487 \dots =: \gamma$.

Similar to the proof of Theorem 5 we then find that for arrangements as in Fig. 10 we have

$$N \approx \frac{(d - 1)(d - 1 + \gamma)(1 + \gamma)}{\gamma^2}.$$

Using this relationship, we can take a similar approach as in the proof of Proposition 1. We leave out the tedious steps and confine ourselves to observing that the slope of the line segments in Fig. 11 is $-(\gamma + 1) = -1.75487 \dots$ and that in arrangements where $T_\alpha^2(\alpha) < p_d$ and $T_\alpha^4(\alpha + 1) > p_d$, we will see that the slope $T'_\alpha(\alpha + 1)$ approaches $-(\gamma + 1)$ as N tends to infinity. However, for our proof the inequality $|T'_\alpha(\alpha + 1)| > \frac{1}{2}(\sqrt{5} + 1) = 1.61803 \dots =: G$ suffices, which turns out to hold for $N \in \mathbb{N}_{\geq 273}$. We will use this to show that for $N \in \mathbb{N}_{\geq 273}$ we have $|T_\alpha^3(R)| > |T_\alpha(\Delta_{d-2})| + |T_\alpha(R)|$. From this it immediately follows that we cannot have that both $T_\alpha(V_1) \subset T_\alpha(R)$ and $T_\alpha(V_2) \subset T_\alpha(\Delta_{d-2})$, and we are done with the proof of Lemma 11.

Since $|T'_\alpha(x)|$ is a decreasing function on I_α , and writing $\beta := |\Delta_{d-2}|$, we have

$$|T_\alpha(\Delta_{d-2})| > |T'_\alpha(\alpha + 1)| \cdot \beta, \quad \text{so} \quad |R| > (|T'_\alpha(\alpha + 1)| - 1)\beta.$$

It follows that

$$|T_\alpha(R)| > (|T'_\alpha(\alpha + 1)| - 1) \cdot |T'_\alpha(p_{d-1})|\beta,$$

that

$$|T_\alpha^2(R)| > (|T'_\alpha(\alpha + 1)| - 1) \cdot |T'_\alpha(p_{d-1})| \cdot |T'_\alpha(f_d)|\beta,$$

and finally that

$$|T_\alpha^3(R)| > (|T'_\alpha(\alpha + 1)| - 1) \cdot |T'_\alpha(p_{d-1})|^2 \cdot |T'_\alpha(f_d)|\beta.$$

We also have $|T_\alpha(\Delta_{d-2})| < |T'_\alpha(p_{d-1})|\beta$, so

$$|R| < (|T'_\alpha(p_{d-1})| - 1)\beta \quad \text{and} \quad |T_\alpha(R)| < |T'_\alpha(f_{d-1})| \cdot (|T'_\alpha(p_{d-1})| - 1)\beta.$$

It follows that

$$\begin{aligned} |T_\alpha(\Delta_{d-2})| + |T_\alpha(R)| &< (|T'_\alpha(p_{d-1})| + |T'_\alpha(f_{d-1})| \cdot (|T'_\alpha(p_{d-1})| - 1))\beta \\ &= (|T'_\alpha(p_{d-1})| - |T'_\alpha(f_{d-1})| + |T'_\alpha(f_{d-1})| \cdot |T'_\alpha(p_{d-1})|)\beta \\ &< |T'_\alpha(f_{d-1})| \cdot |T'_\alpha(p_{d-1})|\beta. \end{aligned}$$

So, although crudely, we certainly have that $|T_\alpha^3(R)| > |T_\alpha(\Delta_{d-2})| + |T_\alpha(R)$ if

$$|T'_\alpha(f_{d-1})| \cdot |T'_\alpha(p_{d-1})| < (|T'_\alpha(\alpha + 1)| - 1) \cdot |T'_\alpha(p_{d-1})|^2 \cdot |T'_\alpha(f_d)|,$$

that is, if

$$1 < (|T'_\alpha(\alpha + 1)| - 1) \cdot |T'_\alpha(p_{d-1})| \cdot \frac{|T'_\alpha(f_d)|}{|T'_\alpha(f_{d-1})|}. \tag{23}$$

Since

$$\begin{aligned} (|T'_\alpha(\alpha + 1)| - 1) \cdot |T'_\alpha(p_{d-1})| \cdot \frac{|T'_\alpha(f_d)|}{|T'_\alpha(f_{d-1})|} &> (|T'_\alpha(\alpha + 1)| - 1) \cdot |T'_\alpha(p_{d-1})| \\ &> (|T'_\alpha(\alpha + 1)| - 1) \cdot |T'_\alpha(\alpha + 1)|, \end{aligned}$$

we know that (23) holds for $|T'_\alpha(\alpha + 1)| > G$, which in turn holds for all $N \in \mathbb{N}_{\geq 273}$. We remark that this value is quite a wide upper bound, since we did a rough approximation. Still, checking that we cannot have both $T_\alpha(V_1) \subset T_\alpha(R)$ and $T_\alpha(V_2) \subset T_\alpha(\Delta_{d-2})$ for smaller N is not that hard and is left to the reader. This finishes the proof of Lemma 10 [cf. case 2 in (22)]. \square

Lemma 10 implies that in case $I_\alpha = \Delta_d \cup \Delta_{d-1} \cup \Delta_{d-2}$ and $f_{d-1} \leq T_\alpha(\alpha) \leq T_\alpha(\alpha + 1)$ or $T_\alpha(\alpha) \leq T_\alpha(\alpha + 1) \leq f_{d-1}$ the division of an interval containing p_d in two smaller ones cannot prevent an overall expansion that excludes any gaps. The other plausible case with three cylinder sets in which gaps might exist is if one outer cylinder set is very small, while the other one is full or nearly full, such that either $T_\alpha^3(\alpha + 1) \geq T_\alpha(\alpha + 1)$ (if Δ_{d-2} is the small cylinder set) or $T_\alpha^3(\alpha) \leq T_\alpha(\alpha)$ (if Δ_d is the small cylinder set). We will show that this is not possible either:

Lemma 11 *Let $I_\alpha = \Delta_d \cup \Delta_{d-1} \cup \Delta_{d-2}$. Then I_α is gapless if*

$$f_{d-1} \leq T_\alpha(\alpha + 1) \leq T_\alpha(\alpha) \quad \text{or} \quad T_\alpha(\alpha + 1) \leq T_\alpha(\alpha) \leq f_{d-1}.$$

Proof of Lemma 11 Taking into account our observations immediately following Definition 4 and the arrangements of Fig. 8 for $N = 23$ and $N = 11$, we only have to prove that there are no α such that $T_\alpha^3(\alpha) < T_\alpha(\alpha)$ is possible if $T_\alpha(\alpha + 1) \leq T_\alpha(\alpha) \leq f_{d-1}$ (in case Δ_d is small) or such that $T_\alpha^3(\alpha + 1) > T_\alpha(\alpha + 1)$ is possible if $f_{d-1} \leq T_\alpha(\alpha + 1) \leq T_\alpha(\alpha)$ (in case Δ_{d-2} is small). Note that the conditions $T_\alpha^3(\alpha) < T_\alpha(\alpha)$ and $T_\alpha^3(\alpha + 1) > T_\alpha(\alpha + 1)$ imply that the branch number is slightly larger than 2. Now remember that I_α consists of m full cylinder sets if and only if $\alpha = k$, $N = mk(k + 1)$ and $d = (m - 1)(k + 1)$ for some $k \in \mathbb{N}$, cf. Theorem 1. Figure 12 shows for increasing

values of N a sequence of arrangements where the branch number b is 2, from one full arrangement (here for $N = 4$) with two cylinders to the next one (here for $N = 12$). Since $|T'_\alpha(\alpha)| > |T'_\alpha(\alpha + 1)|$, the arrangements suggest that in case b is slightly larger than 2, the most favourable arrangement for $T_\alpha^3(\alpha + 1) = T_\alpha(\alpha + 1)$ to have real roots is if $N = 2k^2 + 2k - 1$, where $k \in \mathbb{N}_{\geq 2}$, while for $T_\alpha^3(\alpha) = T_\alpha(\alpha)$ to have real roots is if $N = 2k^2 + 2k + 1$, where $k \in \mathbb{N}$. We will confine ourselves to investigating only the possibility of $T_\alpha^3(\alpha + 1) = T_\alpha(\alpha + 1)$; the calculations for the other case are similar.

So we will try and find out if for $N = 2k^2 + 2k - 1$, $d = k + 1$, with $k \in \mathbb{N}_{\geq 2}$, the positive root of $T_\alpha^3(\alpha + 1) = T_\alpha(\alpha + 1)$ lies in I_α . To do this, we solve

$$\frac{\frac{2k^2 + 2k - 1}{2k^2 + 2k - 1} - (k + 1)}{\frac{2k^2 + 2k - 1}{\alpha + 1} - (k - 1)} = \frac{2k^2 + 2k - 1}{\alpha + 1} - (k - 1),$$

which is reducible to

$$(2k^3 + 6k^2 - k - 1)\alpha^2 + (2k^4 + 5k^2 + k - 2)\alpha - (4k^5 + 6k^4 + 2k^3 - 3k^2 - k + 1) = 0,$$

yielding

$$\alpha = \frac{\sqrt{36k^8 + 144k^7 + 164k^6 - 12k^5 - 95k^4 - 2k^3 + 21k^2 - 4k - (2k^4 + 5k^2 + k - 2)}}{2(2k^3 + 6k^2 - k - 1)} \tag{24}$$

A straightforward computation shows that this last expression is smaller than f_{k+2} , meaning that the root (24) lies outside I_α if $I_\alpha = \Delta_{k+1} \cup \Delta_k \cup \Delta_{k-1}$. Since $N = 2k^2 + 2k - 1$ was the most favourable option for investigation, this finishes our proof [cf. case 3 in (22)]. \square

Remark 14 The arrangement for $N = 11$ in Fig. 8 illustrates that the difference between $T_\alpha^3(\alpha + 1)$ and $T_\alpha(\alpha + 1)$ may be very small.

4.2 A sufficient condition for gaplessness in case I_α consists of four cylinder sets

In the previous subsection we proved Theorem 6 for $m = 2$, by proving Lemmas 9, 10 and 11. In this subsection we will consider $m = 3$ and go into the analogons of Lemmas 9, 10 and 11.

If I_α consists of four cylinder sets, the analogon of Lemma 9 is that arrangements I_α are gapless if $I_\alpha = \Delta_d \cup \Delta_{d-1} \cup \Delta_{d-2} \cup \Delta_{d-3}$ while $T_\alpha(\alpha) \geq f_{d-1}$ and $T_\alpha(\alpha + 1) \leq f_{d-2}$. The analogon of Lemma 11 is that arrangements I_α are gapless if $I_\alpha = \Delta_d \cup \Delta_{d-1} \cup \Delta_{d-2} \cup \Delta_{d-3}$ while $f_{d-2} \leq T_\alpha(\alpha + 1) \leq T_\alpha(\alpha)$ or $T_\alpha(\alpha + 1) \leq T_\alpha(\alpha) \leq f_{d-1}$. In both cases branch numbers larger than 3 are involved, in which case $|T'_\alpha(\alpha + 1)| > 2$ if $N \in \mathbb{N}_{\geq 18}$ (and Theorem 3 yields the desired result). The cases $2 \leq N \leq 17$ can be checked manually and are left to the reader; in Fig. 13 the arrangement for $N = 11$, associated with Lemma 11, illustrates that gaps are out of the question.

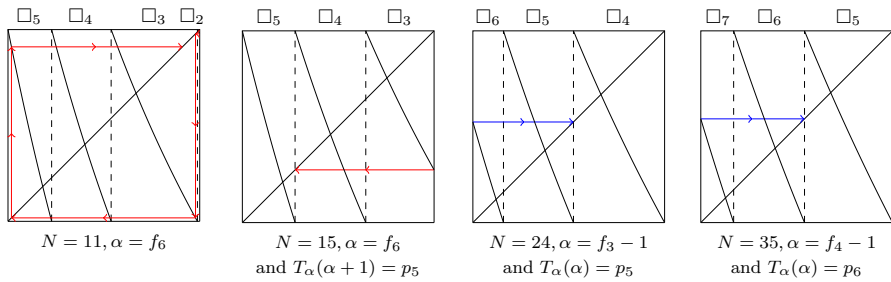

Fig. 13 Four arrangements with two full cylinders

The analogon of Lemma 10 is that arrangements I_α are gapless if $I_\alpha = \Delta_d \cup \Delta_{d-1} \cup \Delta_{d-2} \cup \Delta_{d-3}$ while $f_{d-1} \leq T_\alpha(\alpha) \leq T_\alpha(\alpha + 1)$ or $T_\alpha(\alpha) \leq T_\alpha(\alpha + 1) \leq f_{d-2}$. The arrangements for $N = 15, N = 24$ and $N = 35$ in Fig. 13 are interesting illustrations of the analogon of Lemma 10 in the case of two full cylinder sets instead of one. We will confine ourselves to the arrangement for $N = 15$; the other ones have similar properties.

The arrangement for $N = 15$ is the boundary case for the situation where we have four cylinders, the left one of which (that would be Δ_6 in this example) is extremely small and the right one is such that almost $p_5 \in T_\alpha^2(T_\alpha(\Delta_6) \setminus \Delta_6)$. The interesting thing is that this option would imply a quick interruption of the expansion of $T_\alpha(\Delta_6) \setminus \Delta_6$, involving two large gaps. But it is not really an option: the arrangement for $N = 15$ in Fig. 13 is exceptional among relatively small N (as well as the arrangements for $N = 24$ and $N = 35$ are), while for $N > 36$ we have $|T'_\alpha(\alpha + 1)| > 2$ if $I_\alpha = \Delta_d \cup \Delta_{d-1} \cup \Delta_{d-2}$ and $N/(\alpha + 1) - (d - 2) = p_d$ or $N/\alpha - d = p_d$. We derived this in a similar way as in the proof of Lemma 10 (see Fig. 11) or the preparations for Theorem 5 (see Fig. 6). Figure 14 shows the associated ‘limit graph’, from which it is easily found that $a = \frac{1}{2}(3 - \sqrt{5})$, yielding branch number $2 + g$, with $g = 1/G$ the small golden section.

With this, we conclude the proof of Theorem 6. □

In the next section we will prove that if $I_\alpha = \Delta_d \cup \Delta_{d-1} \cup \Delta_{d-2} \cup \Delta_{d-3}$ gaps exist only in very rare cases and if they do, that they are very large. After that, we will finish the proof of Theorem 4, stating that all arrangements with five cylinders are gapless.

5 Gaplessness in case I_α contains two full cylinder sets

If an arrangement contains three cylinders, and two of them are full, the arrangement is gapless according to Theorem 6. In this section we will prove that arrangements of four cylinders generally do not contain a gap either, save for special values of N . The core of this proof rests on values of α satisfying one of the equations

$$T_\alpha(\alpha) = T_\alpha^3(\alpha) \text{ (with root } \alpha_\ell) \text{ and } T_\alpha(\alpha + 1) = T_\alpha^3(\alpha + 1) \text{ (with root } \alpha_u).$$

We will show that for N such that $\alpha_\ell < \alpha_u$ very large gaps exist for $\alpha \in [\alpha_\ell, \alpha_u]$.

Fig. 14 The ‘limit graph’ of T_α , translated over $(-\alpha, -\alpha)$, under the conditions $I_\alpha = \Delta_d \cup \Delta_{d-1} \cup \Delta_{d-2}$ and $N/(\alpha + 1) - (d - 2) = p_d$ for $N \rightarrow \infty$ (and $\alpha, d \rightarrow \infty$ accordingly)

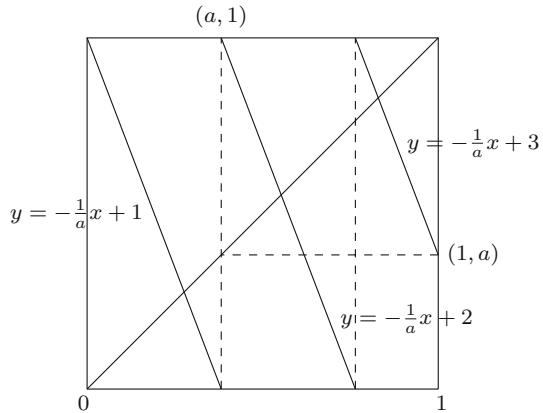

The central theorem of this section is the following:

Theorem 7 Let $N \in \mathbb{N}_{\geq 2}$ and $I_\alpha = \Delta_d \cup \Delta_{d-1} \cup \Delta_{d-2} \cup \Delta_{d-3}$. Then there is a gap in I_α if and only if $N = 2k^2 + 2k - i$, with $k > 1$ and $i \in \{1, 2, 3\}$. Moreover, if there is a gap in I_α , the gap contains f_{d-1} and f_{d-2} , while Δ_d and Δ_{d-3} are gapless.

Proof of Theorem 7 Suppose that there is a gap containing f_{d-1} and f_{d-2} in I_α and that Δ_d and Δ_{d-3} are gapless. Then, as a sub-interval of a gap, the interval (f_{d-1}, f_{d-2}) is a gap. Since $f_{d-1} < f_{d-2}$, $N/(f_{d-1} + d - 1) = f_{d-1}$ and $N/(f_{d-2} + d - 2) = f_{d-2}$, we know that

$$(f_{d-1}, f_{d-2}) \subsetneq \left(\frac{N}{f_{d-2} + d - 1}, \frac{N}{f_{d-1} + d - 2} \right),$$

where the larger open interval is a gap as well. What is more, the infinite sequence of intervals

$$\begin{aligned} (f_{d-1}, f_{d-2}) &\subsetneq \left(\frac{N}{f_{d-2} + d - 1}, \frac{N}{f_{d-1} + d - 2} \right) \\ &\subsetneq \left(\frac{N}{\frac{N}{f_{d-1} + d - 2} + d - 1}, \frac{N}{\frac{N}{f_{d-2} + d - 1} + d - 2} \right) \subsetneq \dots \end{aligned}$$

consists of the union of (f_{d-1}, f_{d-2}) with pre-images of (f_{d-1}, f_{d-2}) in Δ_{d-1} and Δ_{d-2} respectively and therefore of gaps containing f_{d-1} and f_{d-2} . It is contained in the closed interval $[q, r]$, with

$$q = \overline{[d - 1, d - 2]}_{N, \alpha} \in \Delta_{d-1} \quad \text{and} \quad r = \overline{[d - 2, d - 1]}_{N, \alpha} \in \Delta_{d-2},$$

yielding

$$T_\alpha^2(q) = q, \quad T_\alpha(q) = r, \quad T_\alpha(r) = q \quad \text{and} \quad T_\alpha^2(r) = r. \tag{25}$$

Since Δ_d and Δ_{d-3} are gapless, $T_\alpha(\alpha)$ and $T_\alpha(\alpha + 1)$ lie outside the interval (q, r) , which is to say

$$pd < T_\alpha(\alpha) \leq q \quad \text{and} \quad r \leq T_\alpha(\alpha + 1) < pd_{-2}.$$

For the images of α under T_α this means that either $T_\alpha^2(\alpha) \in \Delta_{d-3}$ or $T_\alpha^2(\alpha) \in \Delta_{d-2}$, in the latter case of which we have, due to the expansiveness of T_α and the equalities of (25),

$$|T_\alpha(\alpha) - q| \leq |T_\alpha^2(\alpha) - r| \leq |T_\alpha^3(\alpha) - q|,$$

with equalities only in the case $T_\alpha(\alpha) = q$. From this we derive that

$$\text{either } T_\alpha^2(\alpha) \in \Delta_{d-3} \quad \text{or} \quad T_\alpha^2(\alpha) \in \Delta_{d-2} \wedge T_\alpha^3(\alpha) \leq T_\alpha(\alpha) \tag{26}$$

and, similarly, that

$$\text{either } T_\alpha^2(\alpha + 1) \in \Delta_d \quad \text{or} \quad T_\alpha^2(\alpha + 1) \in \Delta_{d-1} \wedge T_\alpha^3(\alpha + 1) \geq T_\alpha(\alpha + 1). \tag{27}$$

In the following we will write $\alpha_u(N, m)$ (u for ‘upper’) for the positive root of the equation $T_\alpha^3(\alpha + 1) = T_\alpha(\alpha + 1)$ (so $T_\alpha(\alpha + 1) = r$) and $\alpha_\ell(N, m)$ (l for ‘lower’) for the positive root of the equation $T_\alpha^3(\alpha) = T_\alpha(\alpha)$ (so $T_\alpha(\alpha) = q$), with m the number of full cylinder sets; in the current case we have $m = 2$. Recall that I_α consists of m full cylinder sets if and only if $\alpha = k$, $N = mk(k + 1)$ and $d = (m - 1)(k + 1)$ for some $k \in \mathbb{N}$, cf. Theorem 1, so if $m = 2$, we have arrangements consisting of two full arrangements only for $\alpha = k$, $N = 2k(k + 1)$ and $d = k + 1$. If N is $2k(k + 1) - n$, with $n \in \mathbb{N}$, and $\alpha = k - x$, with $x \in \mathbb{R}$, we have

$$b(N, \alpha) = \frac{2k^2 + 2k - n}{(k - x)(k + 1 - x)} = 2 + \frac{4xk - n + 2x - 2x^2}{(k - 1)(k + 1 - x)} > 2 + \frac{4xk - n}{k^2 + x^2},$$

which is a little bit larger than 2 provided x and n are relatively small. For these arrangements we have

$$d(\alpha) = \left\lfloor \frac{2k^2 + 2k - n}{k - x} - (k - x) \right\rfloor = \left\lfloor k + 2 + 3x + \frac{2x^2 + 2x - n}{k - x} \right\rfloor = k + 2$$

and

$$\begin{aligned} d(\alpha + 1) &= \left\lfloor \frac{2k^2 + 2k - n}{k + 1 - x} - (k + 1 - x) \right\rfloor = \left\lfloor k - 1 + 3x + \frac{2x^2 + 2x - n}{k + 1 - x} \right\rfloor \\ &= k - 1. \end{aligned}$$

So, for x and n relatively small, the arrangements consist of four cylinders, while the branch number is only a little bit larger than 2. We will now use this to finish the forward implication of Theorem 7.

Fig. 15 Arrangement with $N = 11, \alpha = 1.8719$

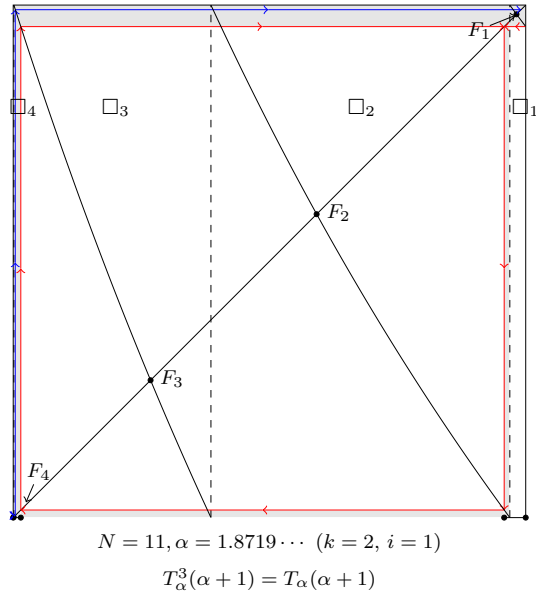

Since Δ_{d-3} decreases and Δ_d increases as α decreases, we see that the assumption that there is a gap containing f_{d-1} and f_{d-2} in I_α implies $\alpha_u(N, 2) \geq \alpha_\ell(N, 2)$. We will shortly show that the only values of N for which $\alpha_u(N, 2) \geq \alpha_\ell(N, 2)$ are $N = 2k^2 + 2k - i$, with $k > 1$ and $i \in \{1, 2, 3\}$; in all cases $d = k + 2$. Although we could keep i as a variable in our calculations, we can limit ourselves to the case $i = 3$, since $i = 3$ is the least favourable value of i allowing for a gap, as is suggested⁶ in Figs. 12, 15, 16, 17 and 18. We will show that for $i = 3$ indeed $\alpha_u(N, 2) \geq \alpha_\ell(N, 2)$. Subsequently we will show that for $4 \leq i \leq 4k$ no gaps exist; the upper bound is $4k$, since $2k^2 + 2k - 4k = 2(k - 1)^2 + 2(k - 1)$, so as to confine the calculations to the group of arrangements where $d = k + 2$.

So, let $N = 2k^2 + 2k - 3$ and $d = k + 2$. Then $\alpha_\ell(N, 2) = [k + 2, \overline{k + 1}, k]$ and $\alpha_u(N, 2) + 1 = [k - 1, \overline{k}, k + 1]$.⁷ Omitting straightforward calculations, we find that

$$\alpha_u(2k^2 + 2k - 3, 2) = \frac{(2k^2 + 2k - 3)\sqrt{D} - (2k^4 + 3k^2 + 3k - 6)}{4k^3 + 12k^2 - 6k - 6}$$

and

$$\alpha_\ell(2k^2 + 2k - 3, 2) = \frac{(2k^2 + 2k - 3)(\sqrt{D} - (k^2 + 5k + 4))}{4k^3 - 18k - 8},$$

⁶ Note that in Fig. 12 we have $d = k + 1$, while there is no small cylinder set Δ_{k+2} .

⁷ We omit the suffix ' N, α ' behind these expansions not only for eligibility but also because α has yet to be determined as the root of $T_\alpha^3(\alpha) = T_\alpha(\alpha)$ or $T_\alpha^3(\alpha + 1) = T_\alpha(\alpha + 1)$.

Fig. 16 Arrangement with $N = 11, \alpha = 1.8687$

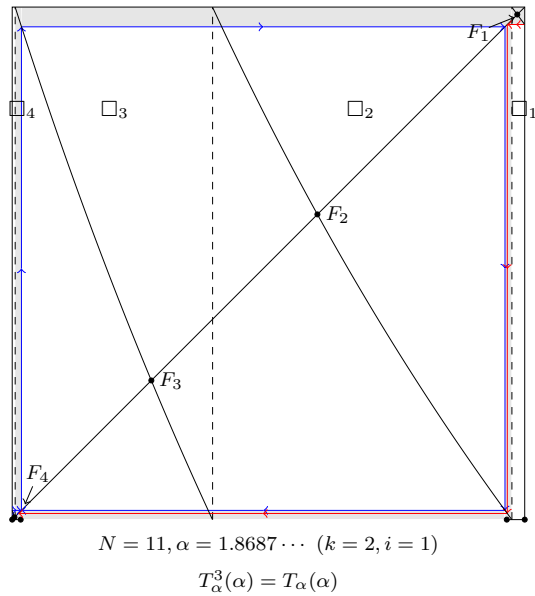

with

$$D = 9k^4 + 18k^3 - 3k^2 - 12k = (3k^2 + 3k - 2)^2 - 4.$$

Since we assume that there is a gap containing f_{d-1} and f_{d-2} , we have $\alpha_u \geq \alpha_\ell$. Omitting the basic calculations, we find that this inequality holds for $k \in \mathbb{N}_{\geq 2}$. In the case $k = 3$ (and so $N = 21$), we have indeed

$$\begin{aligned} \alpha_u(2k^2 + 2k - 3, 2) &= \frac{\sqrt{508032} - 192}{192} = 2.7123 \dots > 2.7122 \dots \\ &= \frac{\sqrt{508032} - 588}{46} = \alpha_\ell(2k^2 + 2k - 3, 2); \end{aligned}$$

see Fig. 19.

Some more basic calculations show that the cases $N = 2k^2 + 2k - 1$ and $N = 2k^2 + 2k - 2$ allow for larger intervals $[\alpha_\ell, \alpha_u]$ where large gaps exist; see the next examples.

$$\begin{aligned} \alpha_u(11, 2) &= \frac{\sqrt{9075} - 26}{37} = 1.8719 \dots \quad \text{and} \quad \alpha_\ell(11, 2) = \frac{99 - \sqrt{9075}}{2} = 1.8686 \dots \\ \alpha_u(10, 2) &= \frac{\sqrt{1725} - 12}{17} = 1.7372 \dots \quad \text{and} \quad \alpha_\ell(10, 2) = \frac{45 - \sqrt{1725}}{2} = 1.7334 \dots \\ \alpha_u(9, 2) &= \frac{\sqrt{5103} - 22}{31} = 1.5946 \dots \quad \text{and} \quad \alpha_\ell(9, 2) = \frac{27 - \sqrt{567}}{2} = 1.5941 \dots \end{aligned}$$

Fig. 17 Arrangement with $N = 10, \alpha = 1.7372$

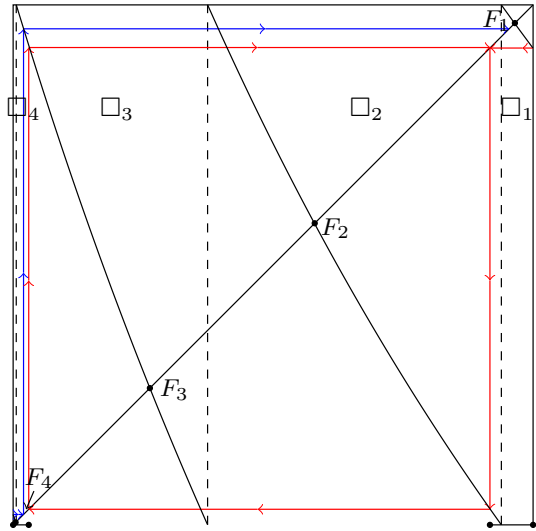

$$N = 10, \alpha = 1.7372 \dots \quad (k = 2, i = 2)$$

$$T_\alpha^3(\alpha + 1) = T_\alpha(\alpha + 1)$$

Fig. 18 Arrangement with $N = 9, \alpha = 1.5946$

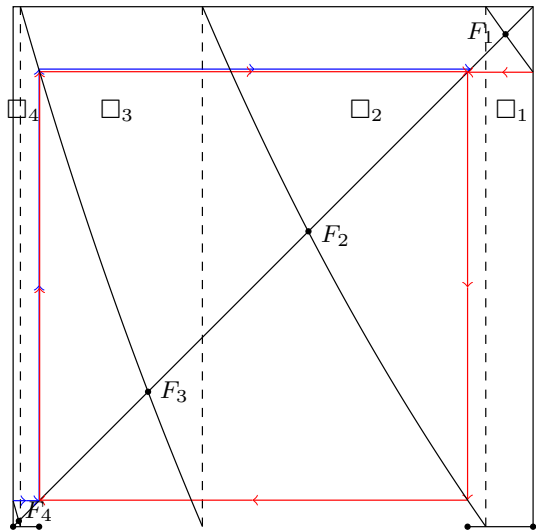

$$N = 9, \alpha = 1.5946 \dots \quad (k = 2, i = 3)$$

$$T_\alpha^3(\alpha + 1) = T_\alpha(\alpha + 1)$$

$$\alpha_u(8, 2) = \frac{\sqrt{228} - 5}{7} = 1.4428 \dots \quad \text{and} \quad \alpha_\ell(8, 2) = 9 - \sqrt{57} = 1.4501 \dots$$

We see that the intervals $\alpha_u - \alpha_\ell$ decrease as N decreases, until (for $N = 8$) the ‘interval’ would have negative length, hence does not exist.

Fig. 19 Arrangement with $N = 21, \alpha = 2.7123$

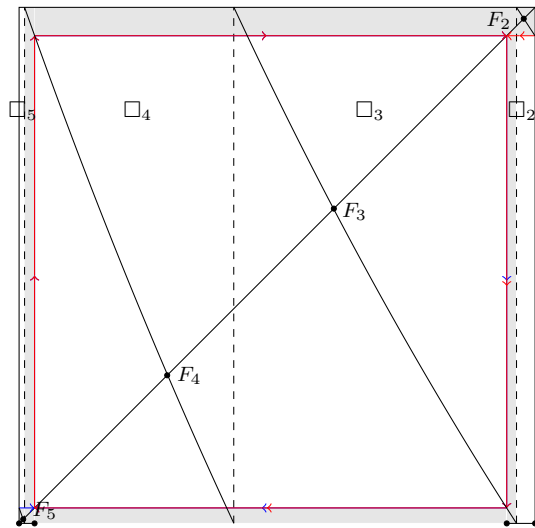

$$N = 21, \alpha = 2.7123$$

$$\alpha_\ell = 2.7122\dots \text{ and } \alpha_u = 2.7123\dots$$

Now suppose $N = 2k^2 + 2k - 4$ (note that voor $k = 2$ we have $N = 8$). Then

$$\alpha_u(2k^2 + 2k - 4, 2) = \frac{(k + 2)\sqrt{D} - (k^3 + k^2 + 2k + 4)}{2(k^2 + 4k + 2)}$$

and

$$\alpha_\ell(2k^2 + 2k - 4, 2) = \frac{(k - 1)\sqrt{D} - (k^3 + 4k^2 - k - 4)}{2(k^2 - 2k - 1)},$$

with

$$D = 9k^4 + 18k^3 - 7k^2 - 16k.$$

There are no gaps provided $\alpha_\ell(2k^2 + 2k - 4, 2) - \alpha_u(2k^2 + 2k - 4, 2) > 0$. Once more we omit the calculations, finding that this inequality holds for $k \in \mathbb{N}_{\geq 2}$, so we conclude that there are no gaps in case $N = 2k^2 + 2k - 4$. If we replace the number 4 in $N = 2k^2 + 2k - 4$ by larger integers (if possible), there will not be any gaps either: the length of the ‘interval’ $[\alpha_\ell, \alpha_u]$ would only become more negative. This concludes the proof that if $I_\alpha = \Delta_d \cup \Delta_{d-1} \cup \Delta_{d-2} \cup \Delta_{d-3}$ and there is a gap containing f_{d-1} and f_{d-2} in I_α , then $N = 2k^2 + 2k - i$, with $k > 1$ and $i \in \{1, 2, 3\}$.

For the *converse statement*, we assume that $N = 2k^2 + 2k - i$, with $k \in \mathbb{N}$ and $i \in \{1, 2, 3\}$. If also $d = k + 2$, then earlier in this proof we showed that only then $\alpha_\ell(N, 2) \leq \alpha_u(N, 2)$. We will show that for α such that $\alpha_\ell(N, 2) \leq \alpha \leq \alpha_u(N, 2)$ there is a gap in $I_\alpha = \Delta_d \cup \Delta_{d-1} \cup \Delta_{d-2} \cup \Delta_{d-3}$ containing both f_{d-1} and f_{d-2} .

Fig. 20 Arrangement with $N = 20, \alpha = 2.6124$

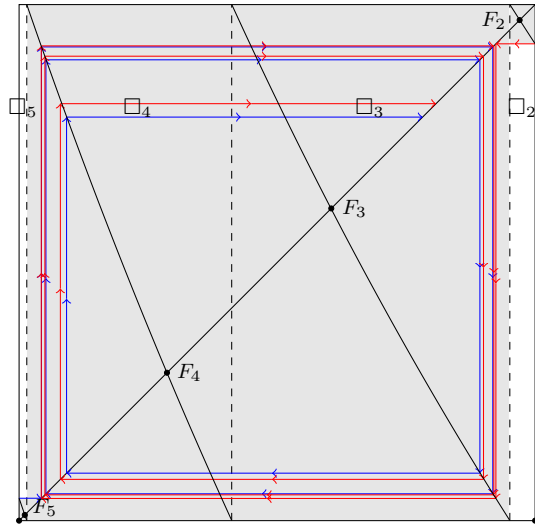

$$N = 20, \alpha = 2.6124$$

$$\alpha_\ell = 2.6132 \dots \text{ and } \alpha_u = 2.6115 \dots$$

As earlier in this proof, we set

$$q = [\overline{d-1, d-2}]_{N,\alpha} \text{ and } r = [\overline{d-2, d-1}]_{N,\alpha}.$$

Set $G = (q, r)$, then clearly both $f_{d-1} \in G$ and $f_{d-2} \in G$. Furthermore, by definition of $\alpha_\ell(N, 2)$ and $\alpha_u(N, 2)$ we have that for every $\alpha \in [\alpha_\ell(N, 2), \alpha_u(N, 2)]$ that

$$T_\alpha(\alpha) \leq q \text{ (and therefore } T_\alpha^2(\alpha) \geq r)$$

and that

$$T_\alpha(\alpha + 1) \geq r \text{ (and therefore } T_\alpha^2(\alpha + 1) \leq q).$$

Note that $T_\alpha((p_d, q)) = (r, \alpha + 1)$ and that $T_\alpha((r, p_{d-2})) = (\alpha, q)$. Then we have that $T_\alpha(G^c) = G^c$, where G^c is the complement of G in I_α . We are left to show that $G = (q, r)$ is a gap; i.e. that for almost all $x \in G$ there exists an $n = n(x)$ such that $T_\alpha^n(x) \in G^c$.

To show this, consider the map $T : I_\alpha \rightarrow I_\alpha$, defined by

$$T(x) = \begin{cases} \frac{-x}{p_d-\alpha} + \frac{(\alpha+1)p_d-\alpha^2}{p_d-\alpha}, & \text{if } x \in \Delta_d; \\ \frac{N}{x} - (d-1), & \text{if } x \in \Delta_{d-1}; \\ \frac{N}{x} - (d-2), & \text{if } x \in \Delta_{d-2}; \\ \frac{-x}{\alpha+1-p_{d-2}} + \frac{(\alpha+1)^2-\alpha p_{d-2}}{\alpha+1-p_{d-2}}, & \text{if } x \in \Delta_{d-3}. \end{cases} \tag{28}$$

Table 1 The thin thread between having a gap or not

	$\alpha_\ell(N, 2)$	$\alpha_u(N, 2)$
$N = 9$	1.594119...	1.594686...
$N = 21$	2.712252...	2.712310...
$N = 37$	3.776839...	3.776851...
$N = 57$	4.817672...	4.817675...
$N = 8$	1.450165...	1.442809...
$N = 20$	2.613247...	2.611575...
$N = 36$	3.700989...	3.700407...
$N = 56$	4.756087...	4.755832...

So on Δ_d and on Δ_{d-3} we have that T is a straight line segment with negative slope, through $(\alpha, \alpha + 1)$ and (p_d, α) on Δ_d , resp. through $(p_{d-2}, \alpha + 1)$ and $(\alpha + 1, \alpha)$ on Δ_{d-3} . For $x \in \Delta_{d-1} \cup \Delta_{d-2}$ we have that $T(x) = T_\alpha(x)$. To show that G is a gap, it is enough to show the ergodicity of T . Then the maximality of G follows from the fact that the support of the absolutely continuous invariant measure is G^c , since $T_\alpha(G^c) = G^c$. The proof of the existence of the absolutely continuous invariant measure for T and its ergodicity is similar to the proof of Theorem 2. Here all branches are complete and the proof is rather simpler. Once we have the ergodicity of T , it is obvious that for a.e. $x \in G$ there exists $n_0 = n_0(x)$ such that $z = T^{n_0}(x) \in G^c$. Then z never returns in G under iterations of T_α . This finishes the proof of Theorem 7. \square

We stress that in the case of $N = 2k^2 + 2k - 3$ the intervals $[\alpha_\ell, \alpha_u]$ on which gaps exist may be very small; see Fig. 19. On the other hand, in case $N = 2k^2 + 2k - 4$, the gaplessness may be a very close call; see Fig. 20. Table 1 illustrates how fast these differences between α_ℓ and α_u decrease as N increases:

Remark 15 While a fixed point f_i is repellent for points within Δ_i , the fixed points in two adjacent cylinder sets behave mutually contracting for all other points in these cylinder sets. As a consequence, it may take quite some time before the orbit of points in the full cylinders of gap arrangements with four cylinders leave these full cylinders for the first time. As an example we take the gap arrangement for $k = 50$ (according to the notations used above). Then $N = 2 \cdot 50^2 + 2 \cdot 50 - 3 = 5097$, $d = 52$ and $\alpha \approx \alpha_u \approx \alpha_\ell \approx 49.98019737$. Table 2 shows for ten values of x between α and $\alpha + 1$ the smallest n such that $T_\alpha^n(x) \notin \Delta_{51} \cup \Delta_{50}$. What is more, there are *uncountably many* x in the gap (a, b) that contains f_{d-1} and f_{d-2} such that $T_\alpha^n(x) \in (a, b)$ for all $n \in \mathbb{N} \setminus \{0\}$. Indeed, for any sequence $(d_1, d_2, \dots, d_n, \dots)$ such that $d_n \in \{d-1, d-2\}$, with $n \in \mathbb{N}$, we have that $x = [d_1, d_2, d_3, \dots]_{N, \alpha} \in (a, b)$.

For the final, second part of the proof of Theorem 4, we will consider one by one all cases left, that is $N \in \{2, \dots, 11\}$. If $N = 11$ and $\alpha \geq f_7$, I_α consists of five cylinder sets if and only if $\alpha \in (f_2 - 1, f_6)$; see the left arrangement of Fig. 21, which we already saw in Fig. 13. Since $\alpha_\ell(11, 3) > \alpha_u(11, 3)$ (cf. page 5), we conclude on similar grounds as in the proof of Theorem 7, that the arrangement is gapless. If $\alpha \in [f_7, f_2 - 1]$, the interval I_α consists of four cylinder sets, implying gaplessness

Table 2 The difficulty of leaving the gap: with $N = 5097$, $\alpha = 49.98019737$, for each of ten values of $x \in [\alpha, \alpha + 1]$ the smallest n is given such that $T_\alpha^n(x) \notin \Delta_{51} \cup \Delta_{50}$

x	50	50.1	50.2	50.3	50.4	50.5	50.6	50.7	50.8	50.9
n	5417	2090	3568	1123	4776	185	5816	16231	5646	7604

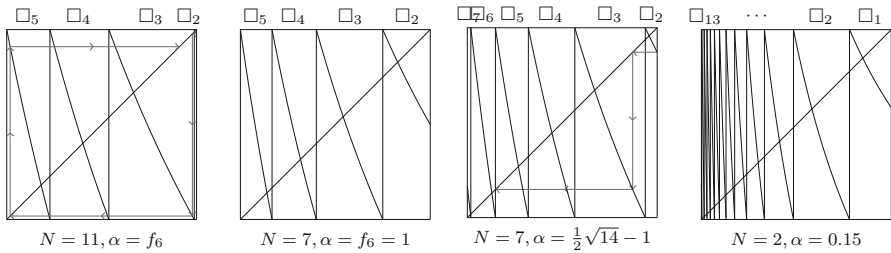

Fig. 21 Borderline cases for part II of the proof of Theorem 4

because of Theorem 7. Since $|T'_\alpha(f_7 + 1)| = 2.04 \dots$, gaps are also excluded for all $\alpha \leq f_7$. A similar approach works for $N = 10$ (with $|T'_\alpha(f_7 + 1)| = 2.03 \dots$), $N = 9$ (with $|T'_\alpha(f_7 + 1)| = 2.02 \dots$) and even $N = 8$, in which case $f_7 = 1$, $|T'_\alpha(f_7 + 1)| = 2$, and the arrangement with four cylinders is full.

For $N \in \{3, \dots, 7\}$ we take a different approach, confining ourselves to the case $N = 7$; the cases $N \in \{3, \dots, 6\}$ are done similarly. We will omit most calculations, which are generally quite tedious and do hardly elucidate anything. So let $N = 7$. Then I_α consists of at least five cylinder sets if and only if $\alpha < f_6$; see the second arrangement of Fig. 21. We have $|T'_\alpha(\alpha + 1)| = 2$ for $\alpha = \frac{1}{2}\sqrt{14} - 1$, in which case $d_{\min} = 2$; see the third arrangement of Fig. 21. Now suppose $\frac{1}{2}\sqrt{14} - 1 \leq \alpha < f_6 = 1$. We have $|T'_\alpha(f_6 + 1)| = \frac{7}{4}$ and $|T'_\alpha(\alpha)| > 7$. Regarding these relatively large values, it is not hard to understand that Δ_2 is gapless. The part of the orbit of $\alpha + 1$ under T_α in the third arrangement of Fig. 21 illustrates that even in the case of $\alpha = \frac{1}{2}\sqrt{14}$, the expansion of $[T_\alpha(\alpha + 1), p_3]$ under T_α clearly excludes the existence of gaps.

Finally, let $N = 2$. We have $|T'_\alpha(f_1)| = 2$, indicating the rapid increase of $|T'_\alpha|$ on I_α if α decreases. The large expansiveness of T_α left of f_1 assures the gaplessness of Δ_1 . We will show that for any $\alpha \in (0, \sqrt{2} - 1]$ the image of $[T_\alpha(\alpha + 1), p_2]$ contains most of the fixed points, implying the gaplessness of I_α ; see the last arrangement of Fig. 21 for an illustration of this. If $T_\alpha(\alpha + 1) \leq f_2$ this is quite obvious, so we assume $T_\alpha(\alpha + 1) > f_2$. Suppose that $T_\alpha^2(\alpha + 1) = f_s$, for some $s \in \mathbb{N}_{\geq 2}$. Then, omitting some basic calculations, we have $\alpha = (s + 1 - \sqrt{s^2 + 8}) / (2s - 7)$, whence

$$d = d(\alpha) = \left\lceil \frac{4s^2 - 11s + (4s - 13)\sqrt{s^2 + 8} - 15}{2s - 7} \right\rceil \geq \frac{4s^2 - 13s + (4s - 13)\sqrt{s^2 + 8} - 8}{2s - 7},$$

from which we derive that $d \geq 4s$.

This finishes the proof of Theorem 4. □

Remark 16 A paper worthwhile to read alongside our paper is [12]. As the title of this paper states, it deals with mixing properties of expanding Lorentz maps. There are many interesting results in [12] that embed the results from our paper in a more general context.

Acknowledgements The first author of this paper is very thankful to the Dutch organisation for scientific research Nederlandse Organisatie voor Wetenschappelijk Onderzoek, which funded his research for this paper with a so-called *Promotiebeurs voor Leraren*, with grant number 023.003.036. The third author's research was partially supported by the Japan Society for the Promotion of Science with Grant-in-Aid for Scientific Research (C) 20K03661. We also want to thank Julian Lyczak, then working at Leiden University, for his help with some programming in the preparatory phase of Sect. 5. We thank Niels Langeveld as well for providing us with Fig. 3. Finally, the authors would also like to thank the anonymous referees for very helpful suggestions which improved the presentation of this paper.

Open Access This article is licensed under a Creative Commons Attribution 4.0 International License, which permits use, sharing, adaptation, distribution and reproduction in any medium or format, as long as you give appropriate credit to the original author(s) and the source, provide a link to the Creative Commons licence, and indicate if changes were made. The images or other third party material in this article are included in the article's Creative Commons licence, unless indicated otherwise in a credit line to the material. If material is not included in the article's Creative Commons licence and your intended use is not permitted by statutory regulation or exceeds the permitted use, you will need to obtain permission directly from the copyright holder. To view a copy of this licence, visit <http://creativecommons.org/licenses/by/4.0/>.

References

1. Anselm, M., Weintraub, S.H.: A generalization of continued fractions. *J. Number Theory* **131**(12), 2442–2460 (2011)
2. Burger, E.B., Gell-Redman, J., Kravitz, R., Walton, D., Yates, N.: Shrinking the period lengths of continued fractions while still capturing convergents. *J. Number Theory* **128**(1), 144–153 (2008)
3. Dajani, K., Kraaikamp, C., Van der Wekken, N.: Ergodicity of N-continued fraction expansions. *J. Number Theory* **133**(9), 3183–3204 (2013)
4. Hofbauer, F.A.: A two parameter family of piecewise linear transformations with negative slope. *Acta Math. Univ. Comenian. (N.S.)* **81**(1), 15–30 (2012)
5. Ito, S., Sadahiro, T.: Beta-expansions with negative bases. *Integers* **9**(A22), 239–259 (2009)
6. Keller, G.: Stochastic stability in some chaotic dynamical systems. *Monatsh. Math.* **94**(4), 313–333 (1982)
7. Komatsu, T.: Shrinking the period length of quasi-periodic continued fractions. *J. Number Theory* **129**(2), 358–366 (2009)
8. Kraaikamp, C., Langeveld, N.: Invariant measures for continued fraction algorithms with finitely many digits. *JMAA* **454**(1), 106–126 (2017)
9. Lasota, A., Yorke, J.A.: On the existence of invariant measures for piecewise monotonic transformations. *TAMS* **186**, 481–488 (1973)
10. Li, T.-Y., Yorke, J.A.: Ergodic transformations from an interval into itself. *TAMS* **235**, 183–192 (1978)
11. Liao, L., Steiner, W.: Dynamical properties of the negative beta-transformation. *Ergodic Theory Dyn. Syst.* **32**(5), 1673–1690 (2012)
12. Oprocha, P., Potorski, P., Raith, P.: Mixing properties in expanding Lorenz maps. *Adv. Math.* **343**, 712–755 (2019)
13. Wilkinson, K.M.: Ergodic properties of a class of piecewise linear transformations. *Z. Wahrscheinlichkeitstheorie und Verw. Gebiete* **31**, 303–328 (1974/75)

Publisher's Note Springer Nature remains neutral with regard to jurisdictional claims in published maps and institutional affiliations.